

**45300**

LEGO and the LEGO logo are trademarks of the/son des marques de commerce  
du/son marcas registradas de LEGO Group. ©2015 The LEGO Group. 088360.



**45300**

LEGO and the LEGO logo are trademarks of the/son des marques de commerce  
du/son marcas registradas de LEGO Group. ©2015 The LEGO Group. 088360.

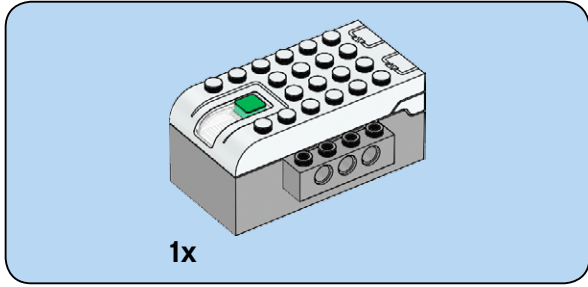

1

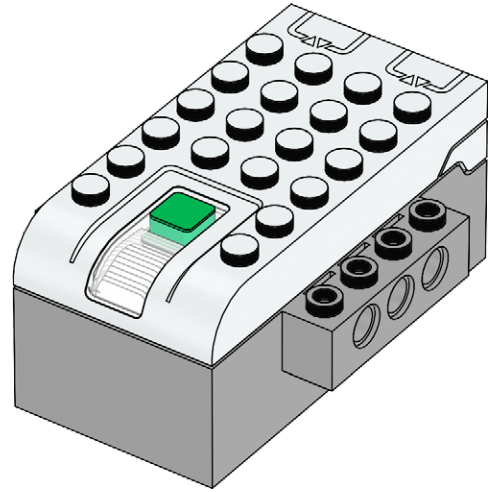

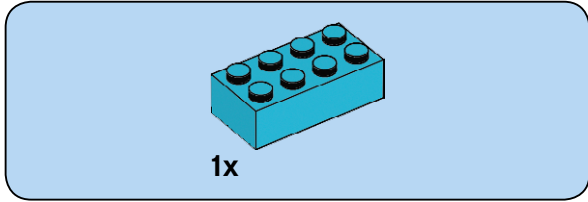

2

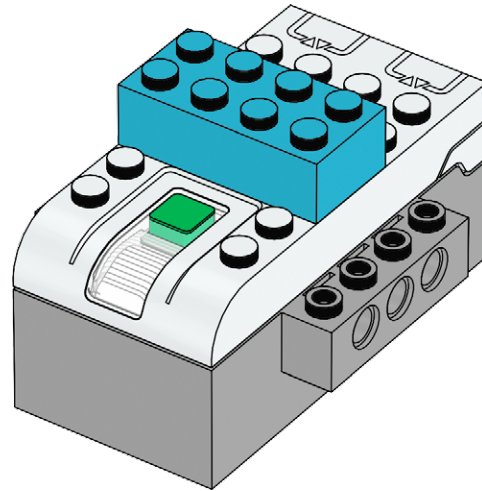

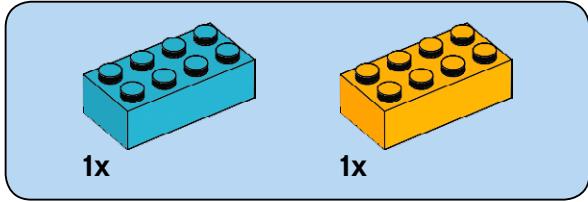

**3**

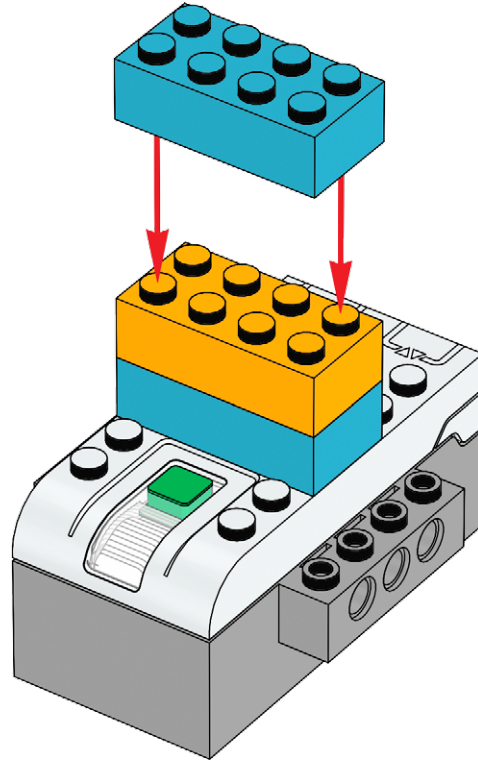

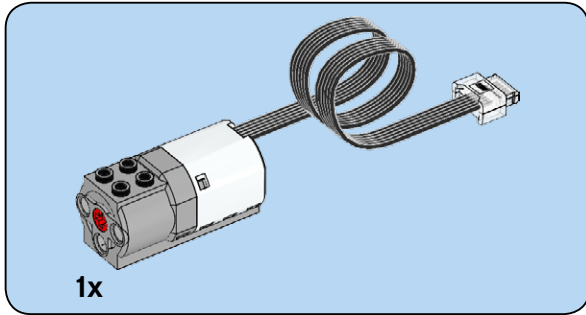

4

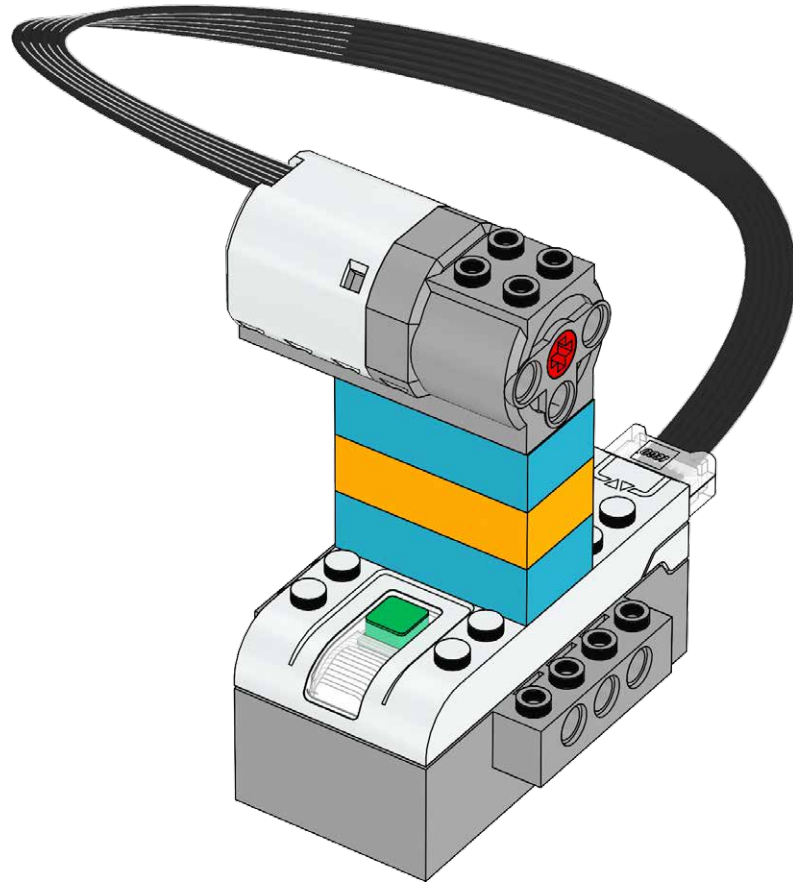

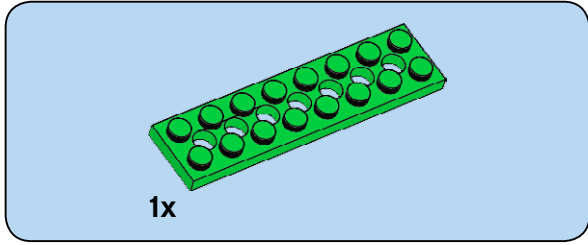

5

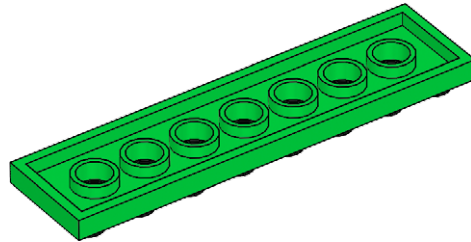

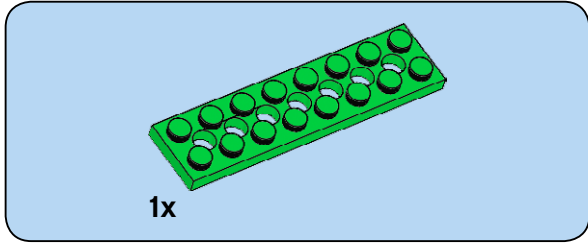

6

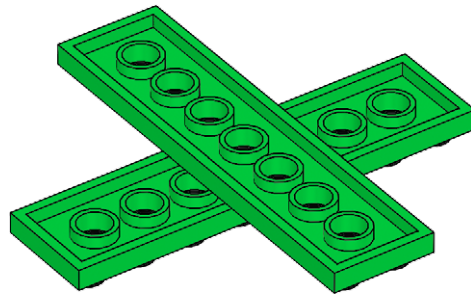



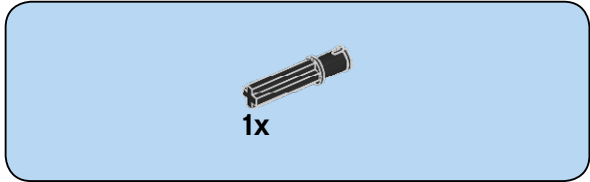

7

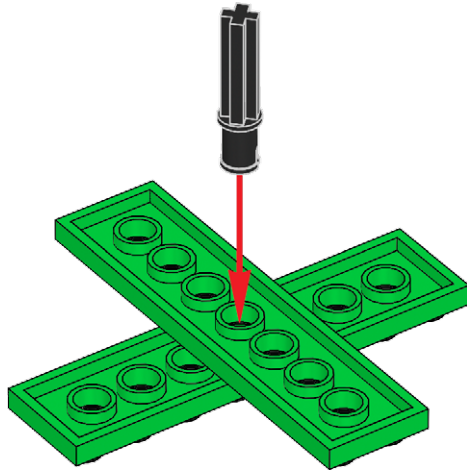

8

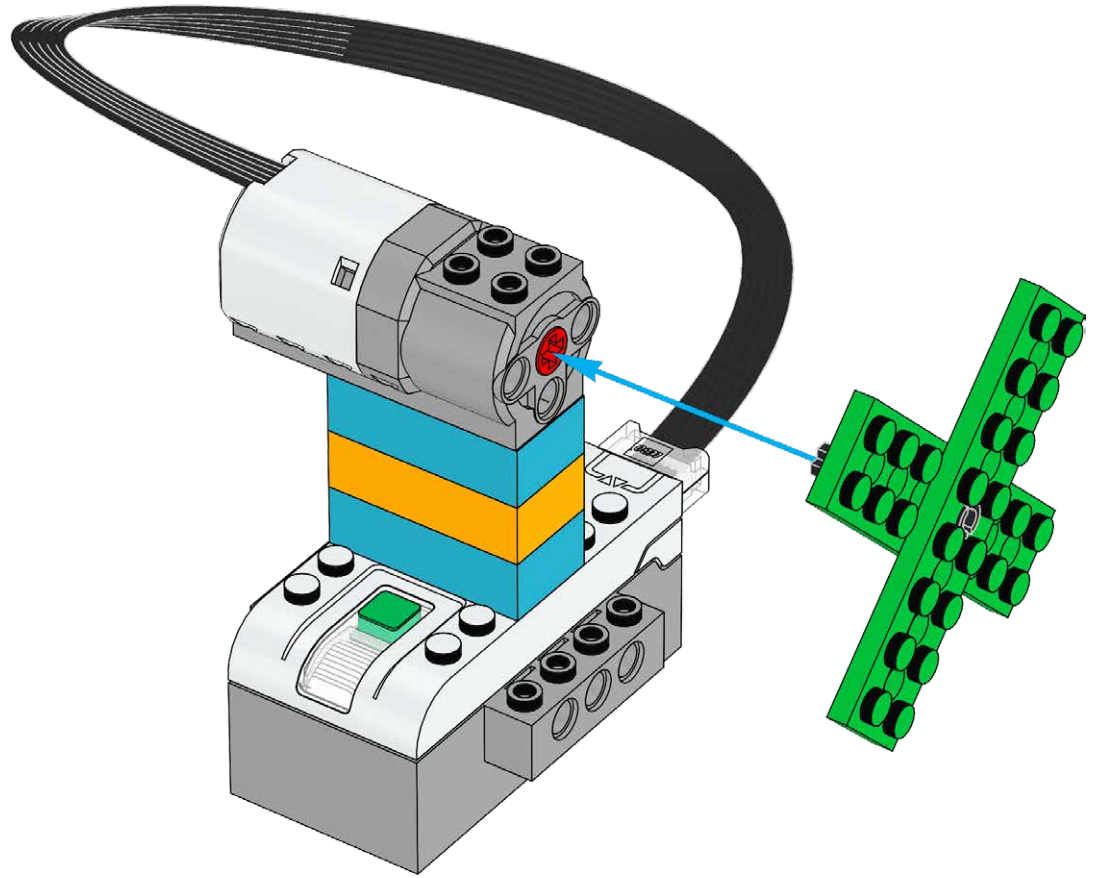

9

