



**1 x 9580**

+



**1 x 9585**

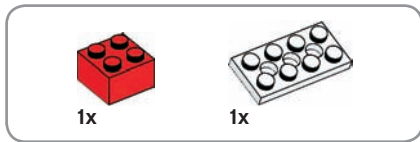

1

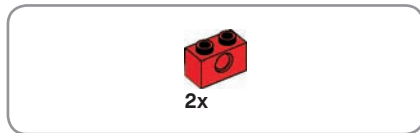
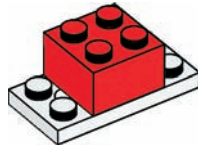

2

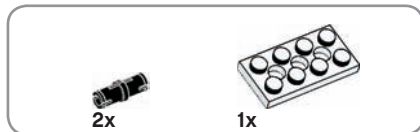
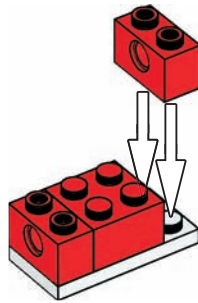

3

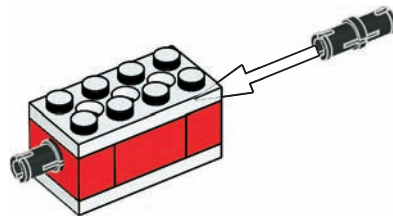

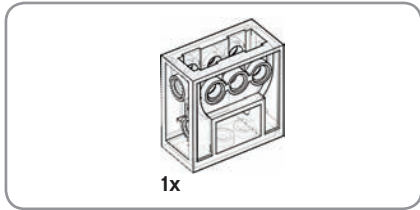

4

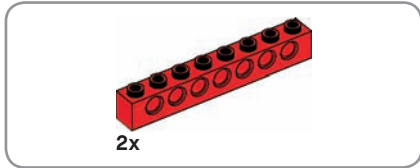
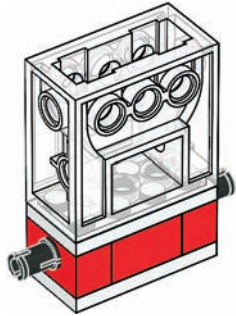

5

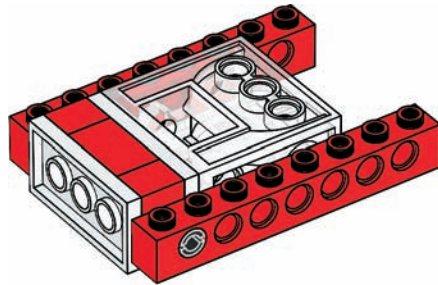





6

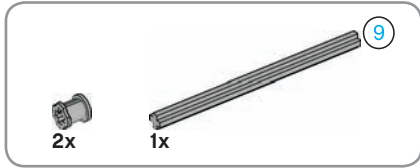
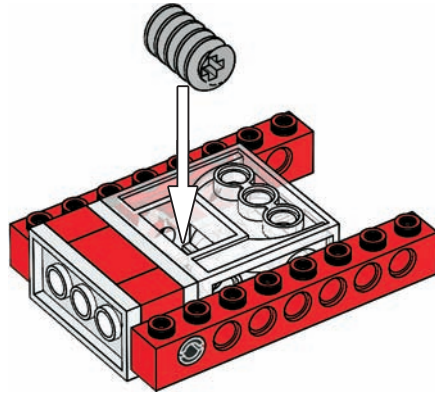

7

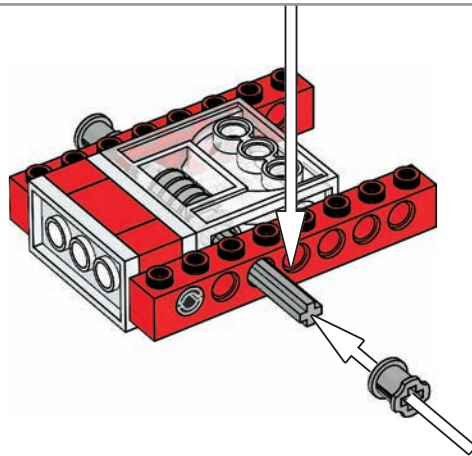
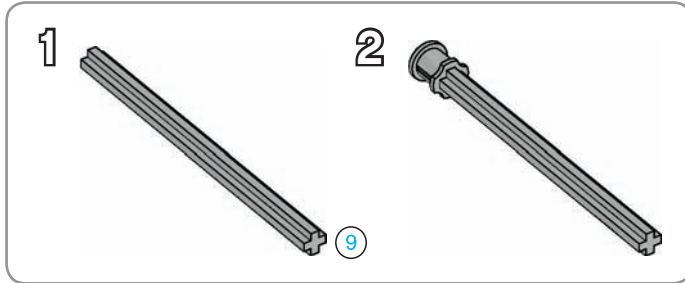

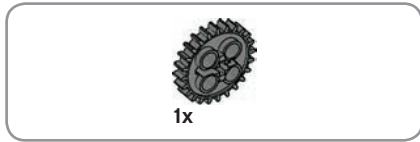

8

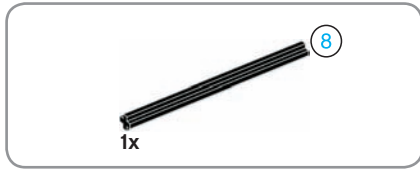
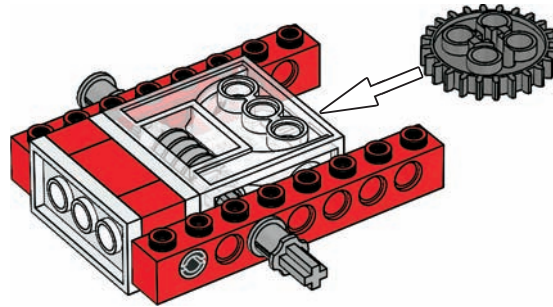

9

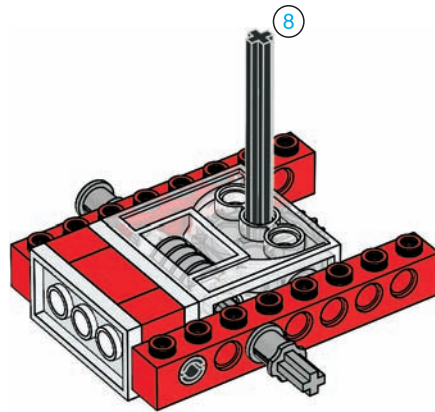

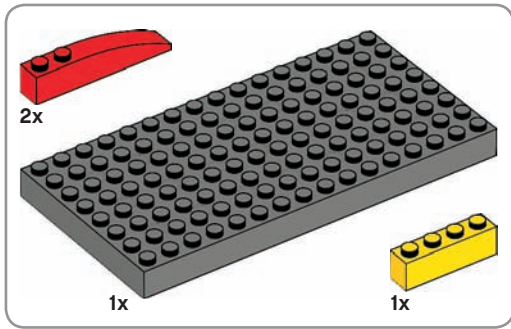

10

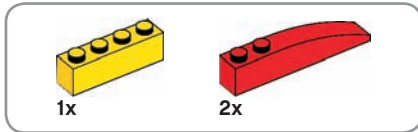
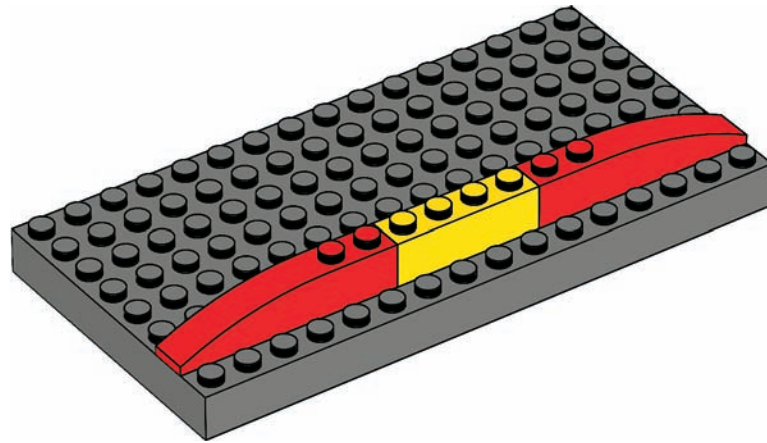

11

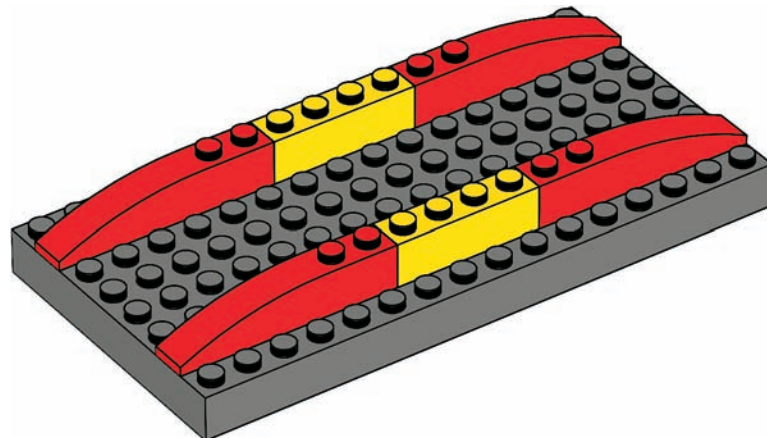

12

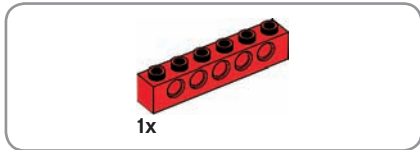
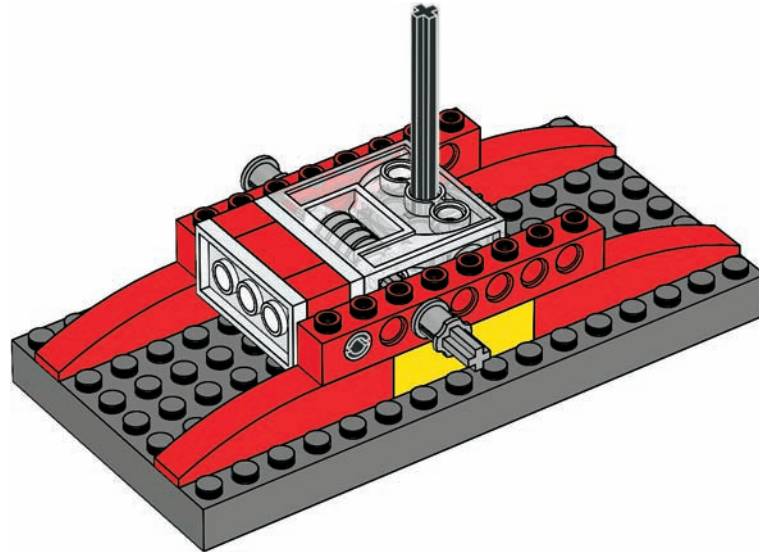

13

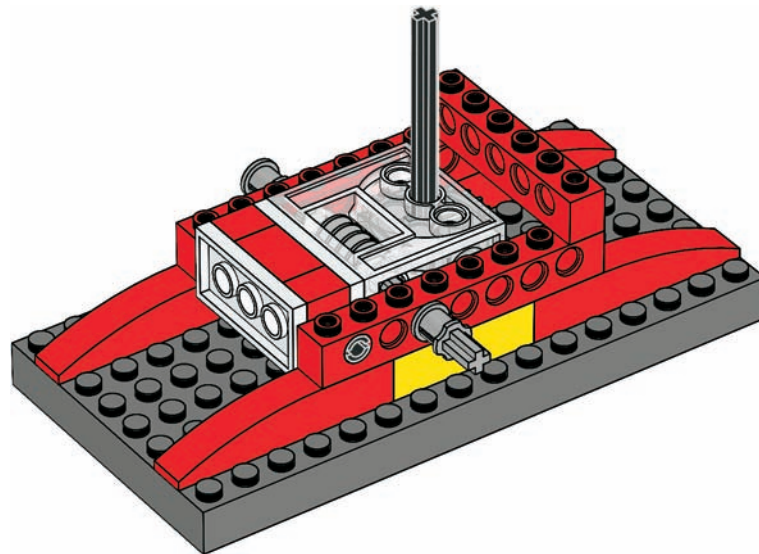

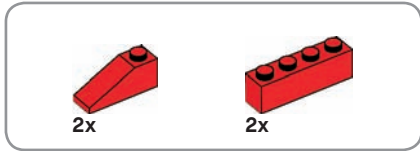

14

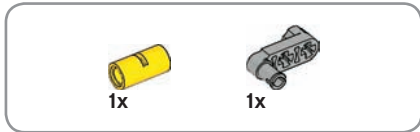
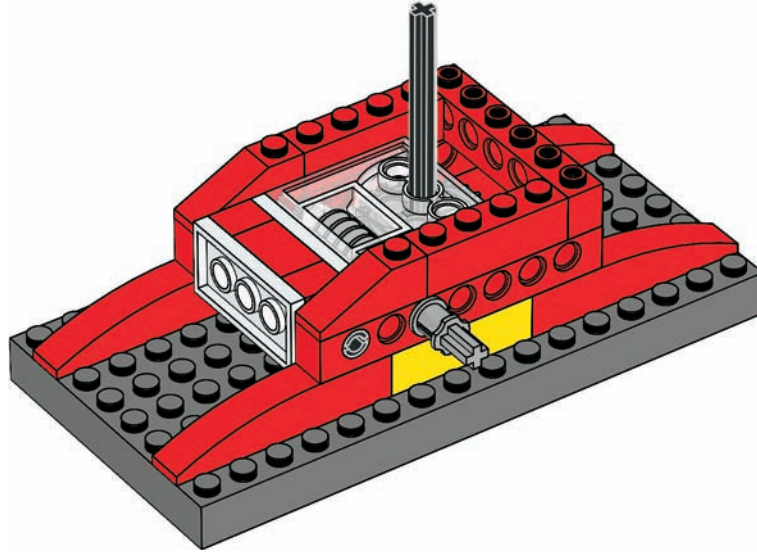

15

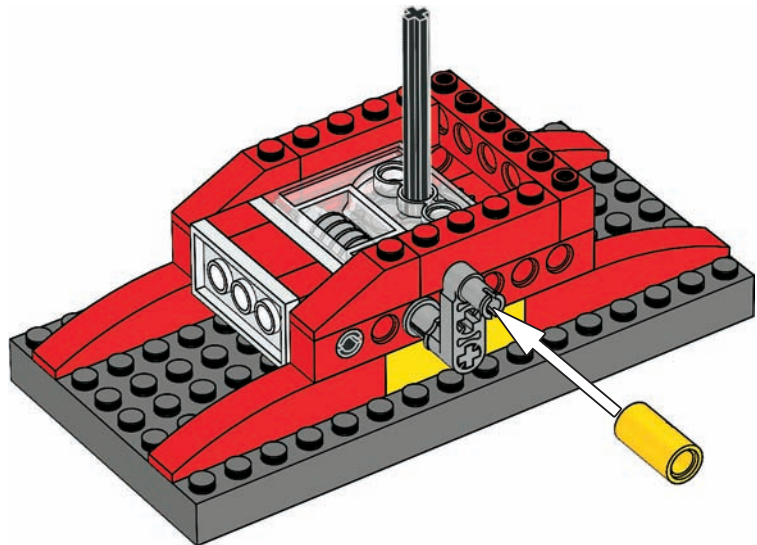





16

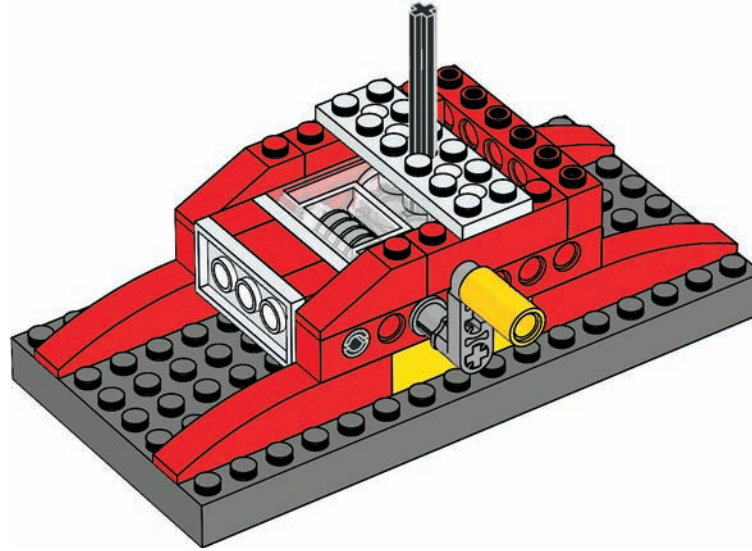

17

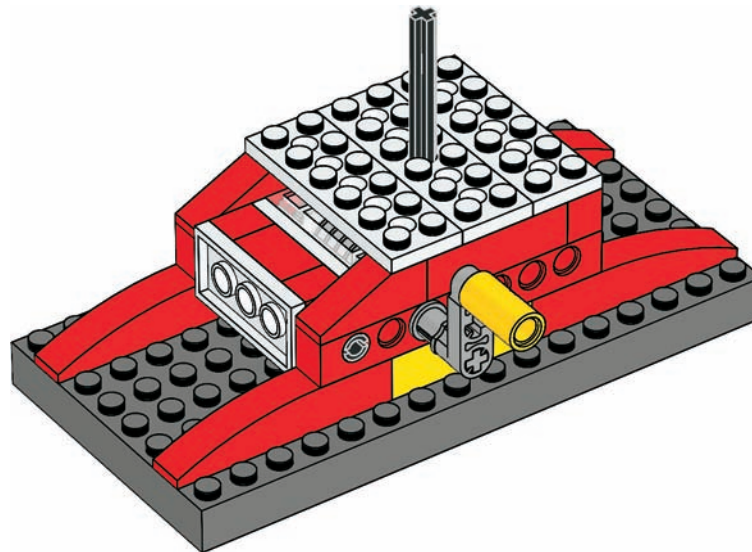

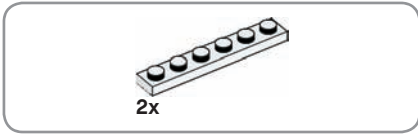

18

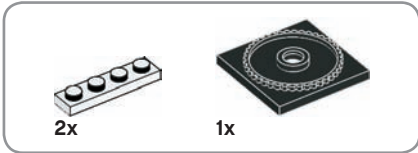
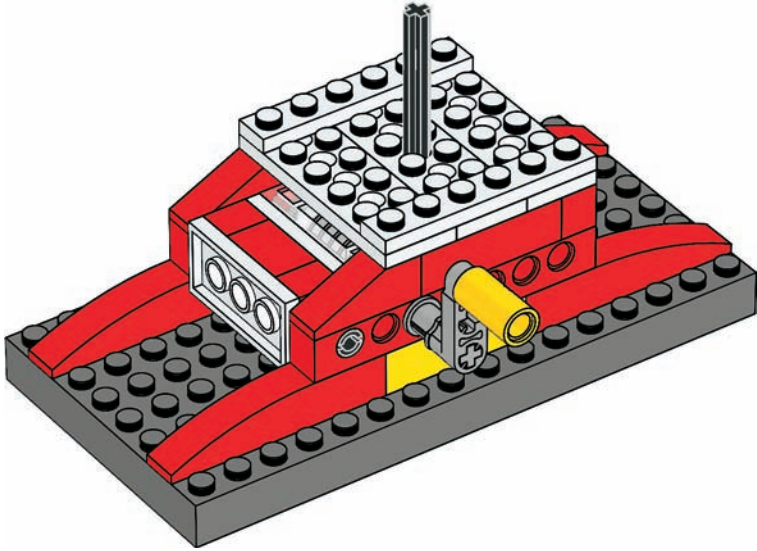

19

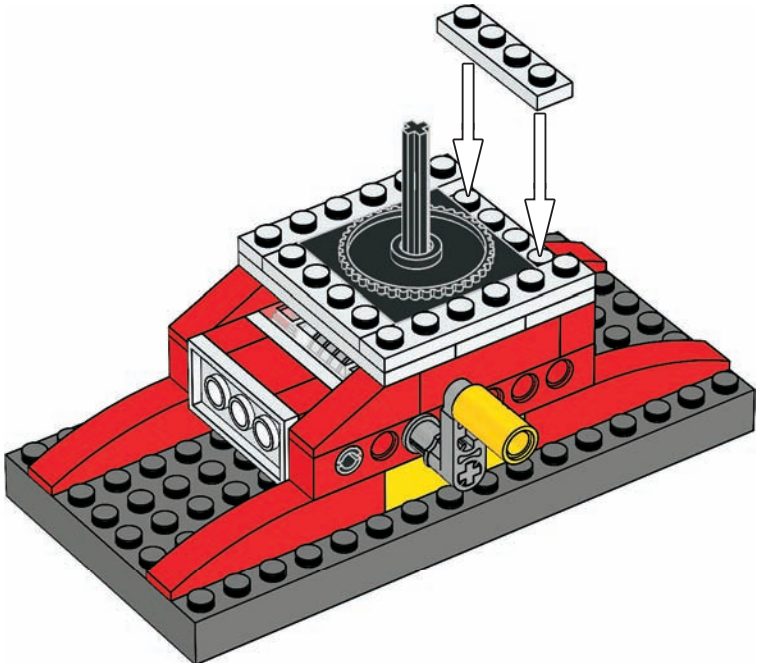



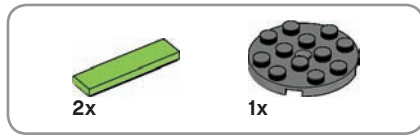

20

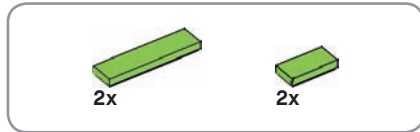
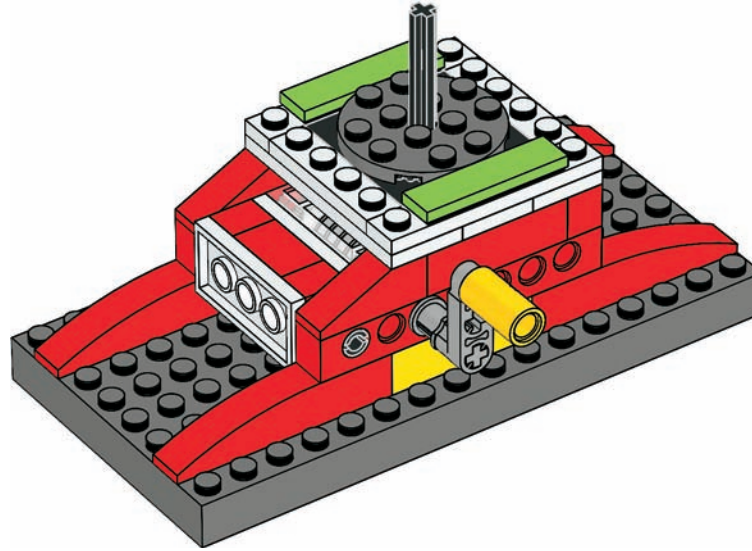

21

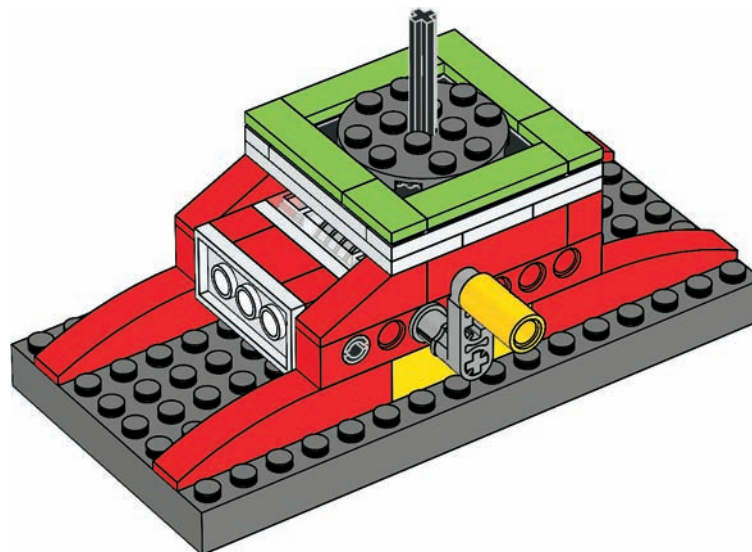



22

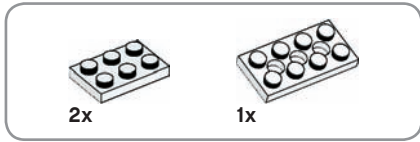
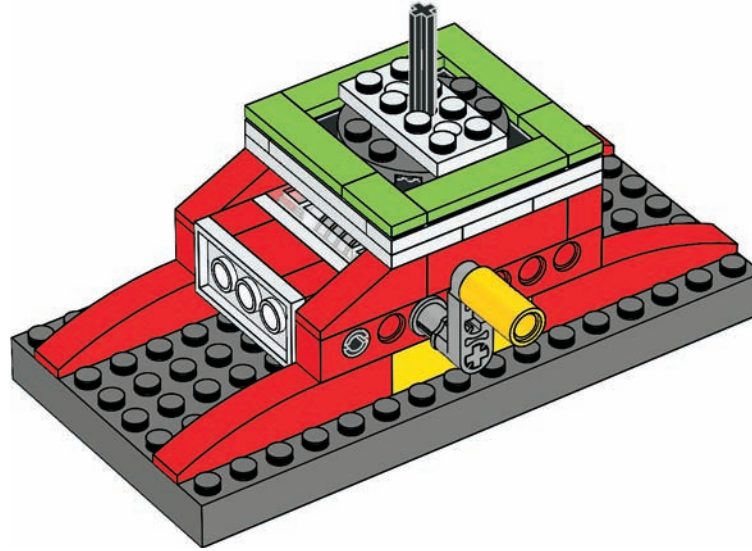

23

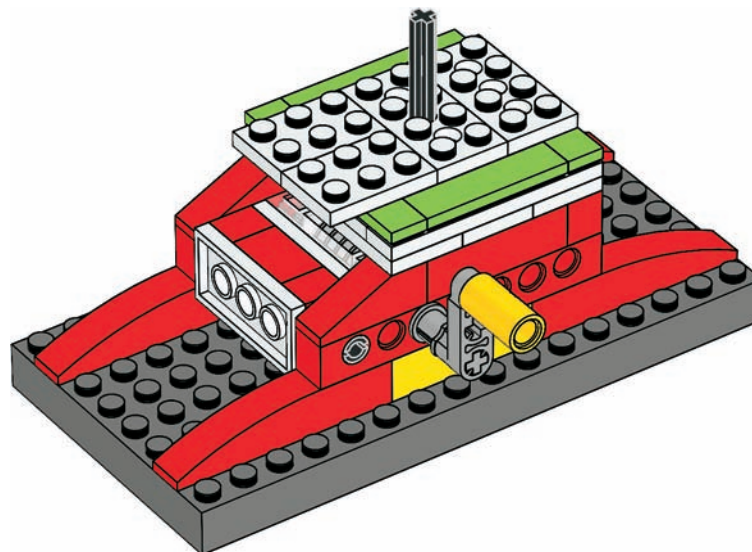



1x

24

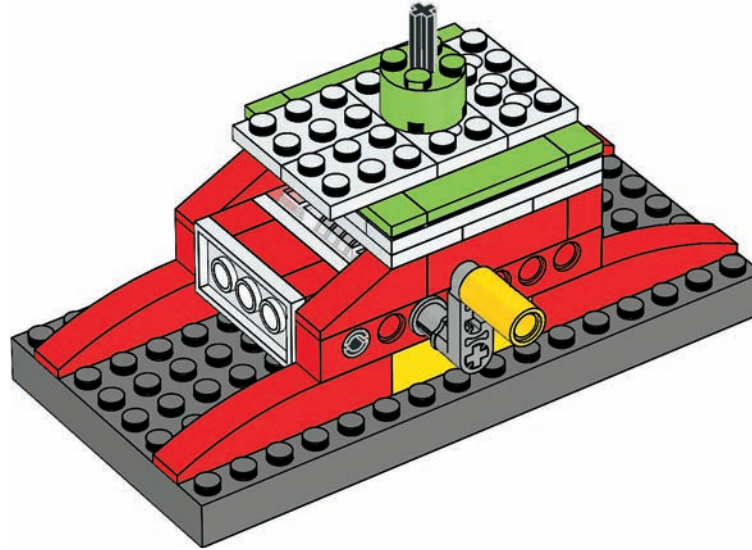

4x



2x

25

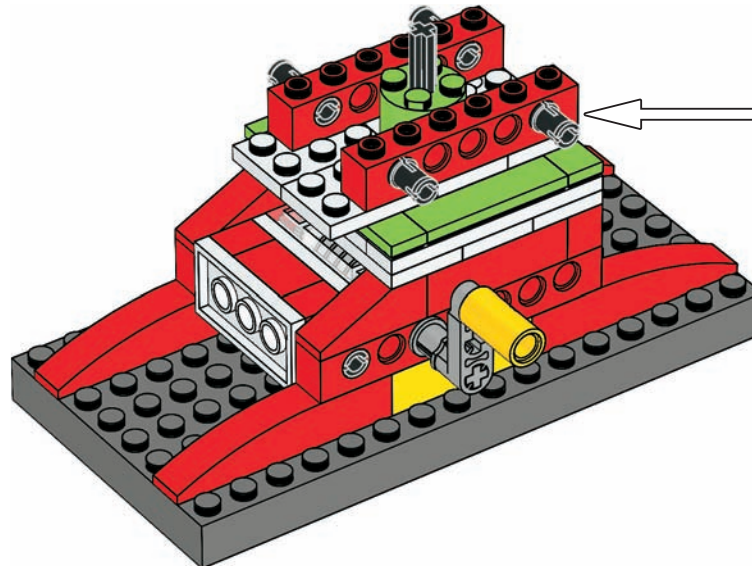

2x

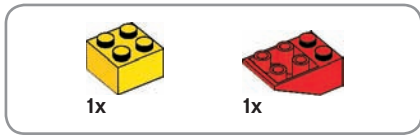

26

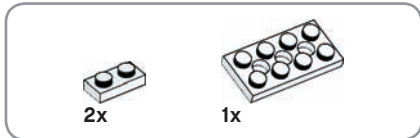
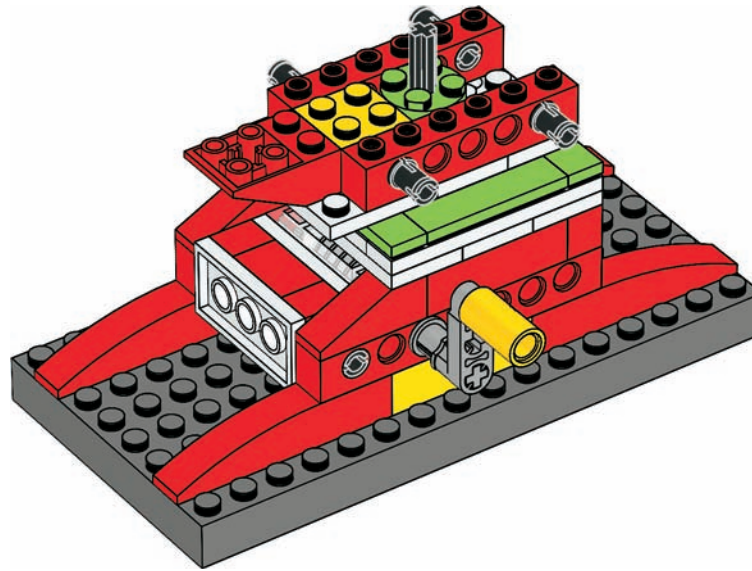

27

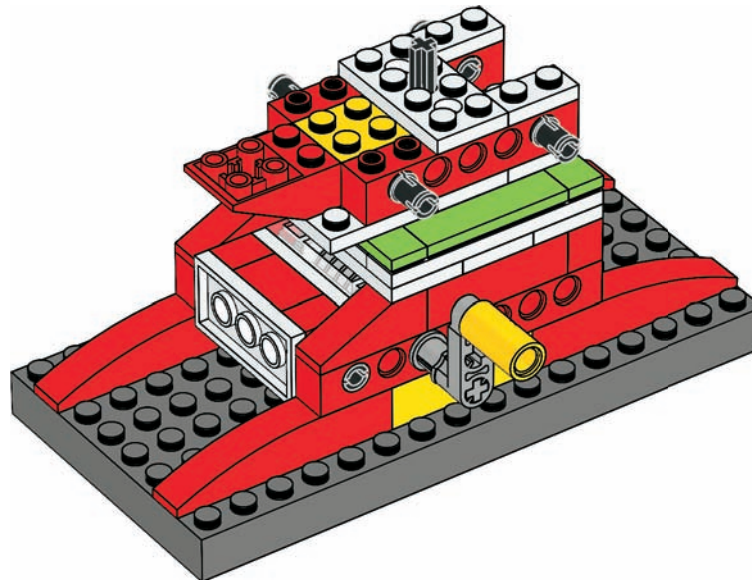





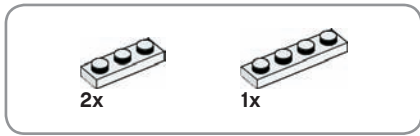

30

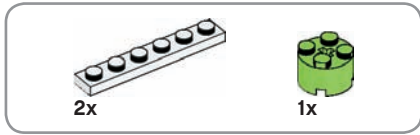
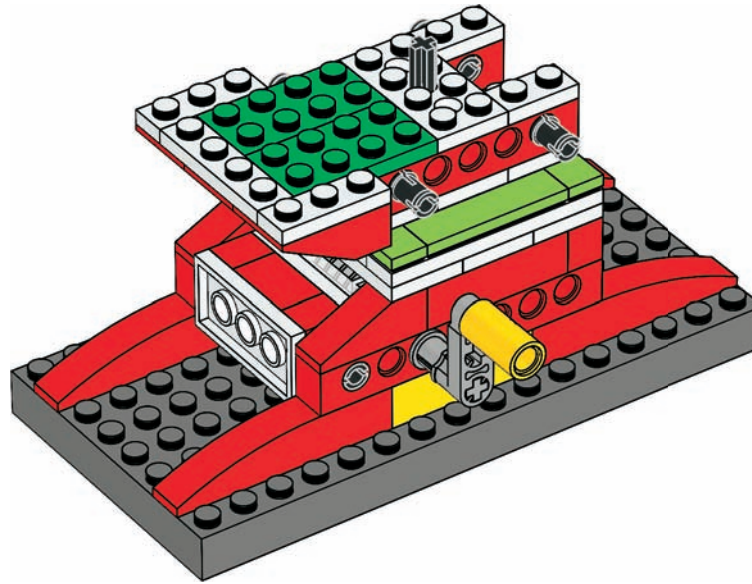

31

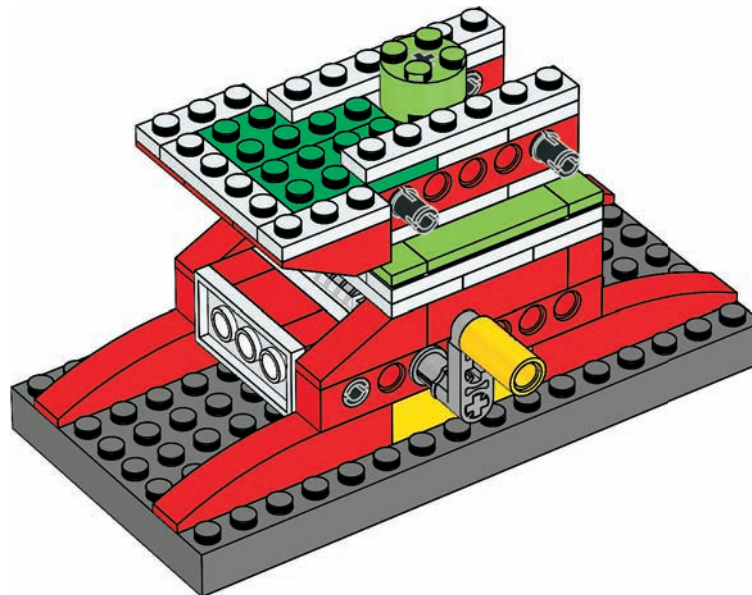

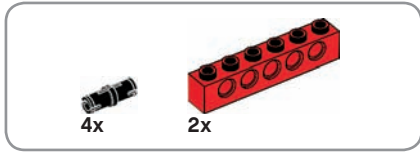

32

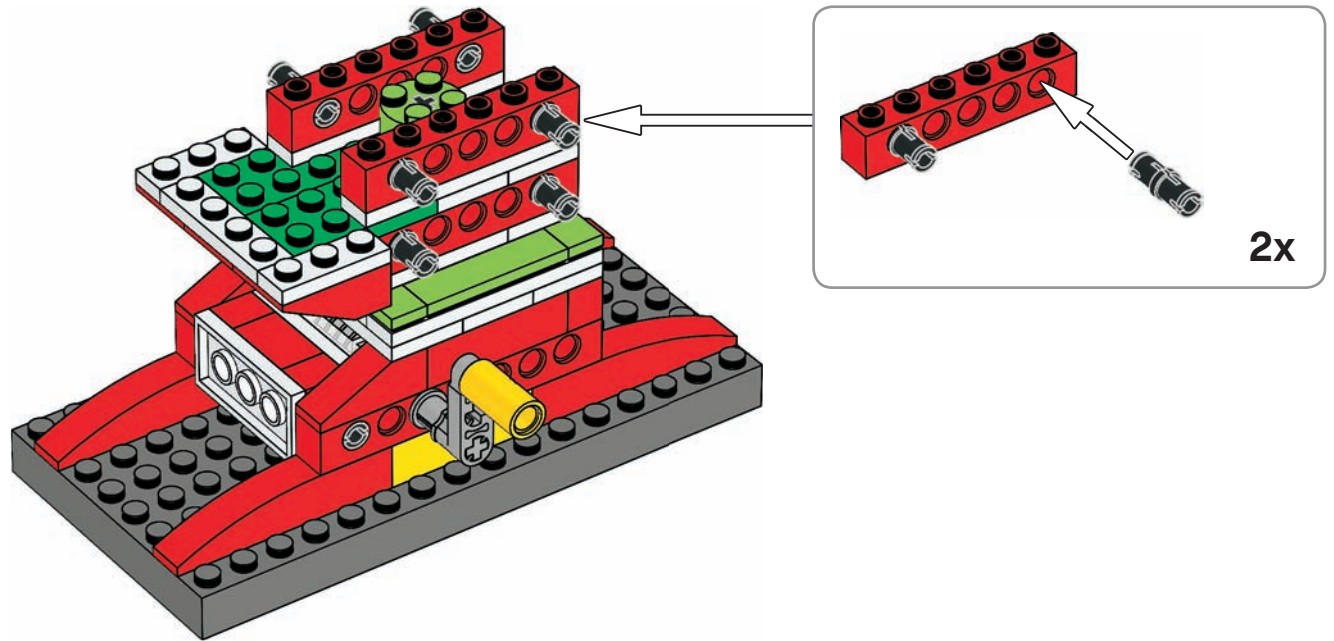



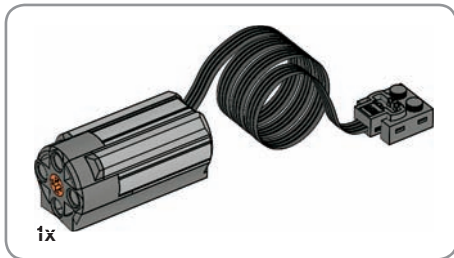

33

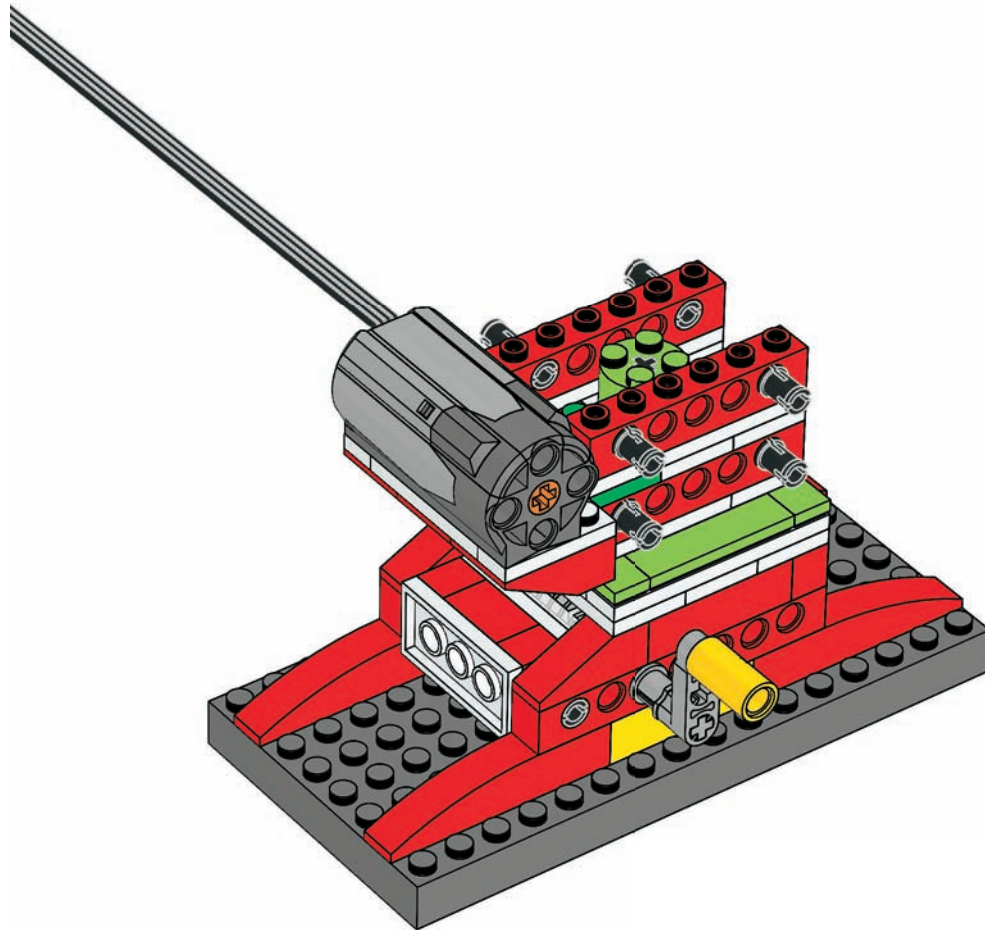

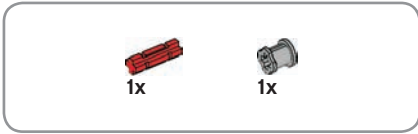

34

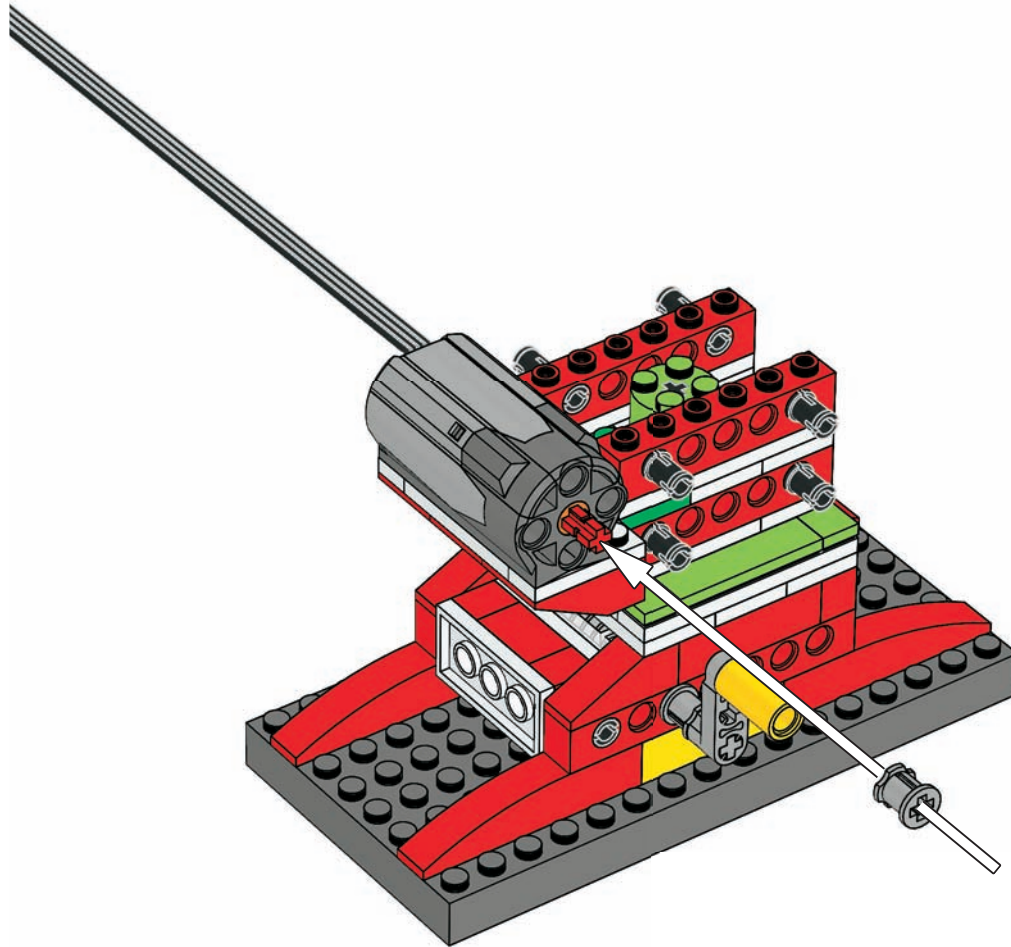

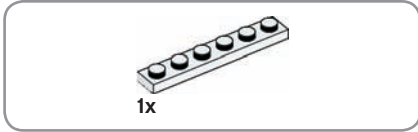

35

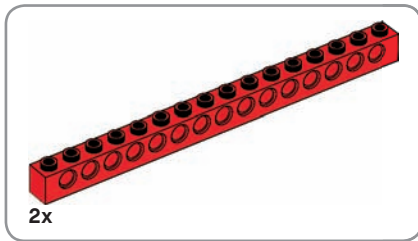
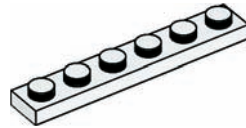

36

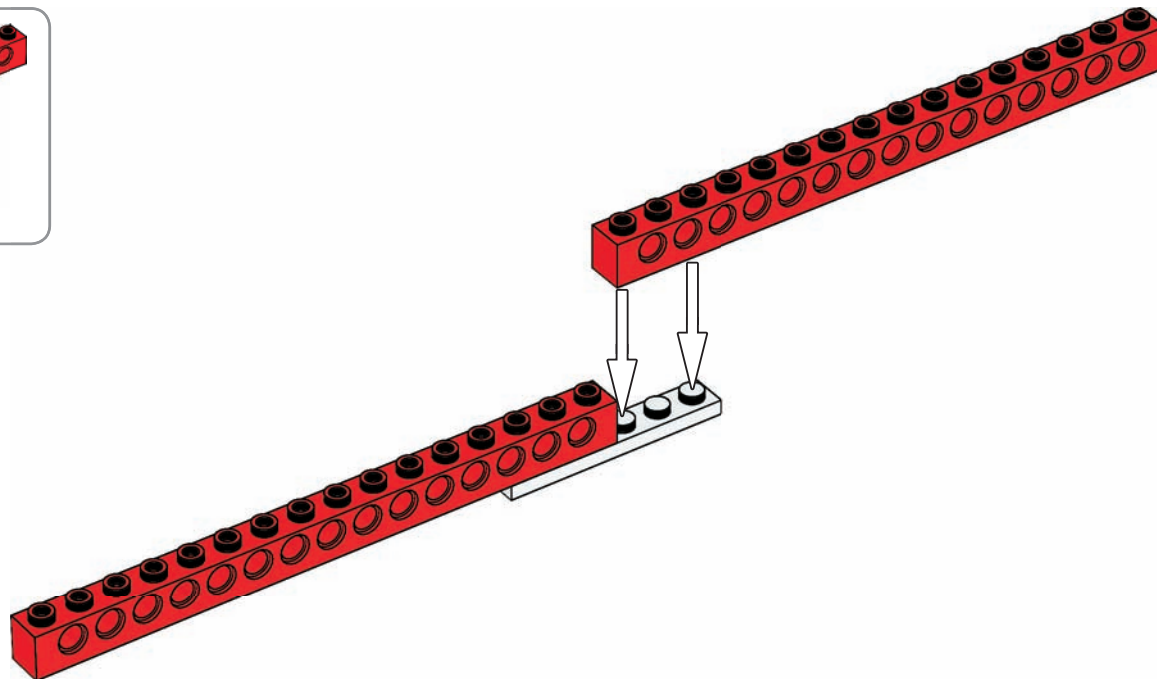

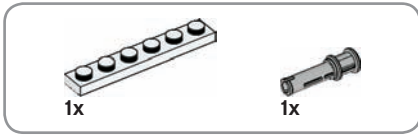

37

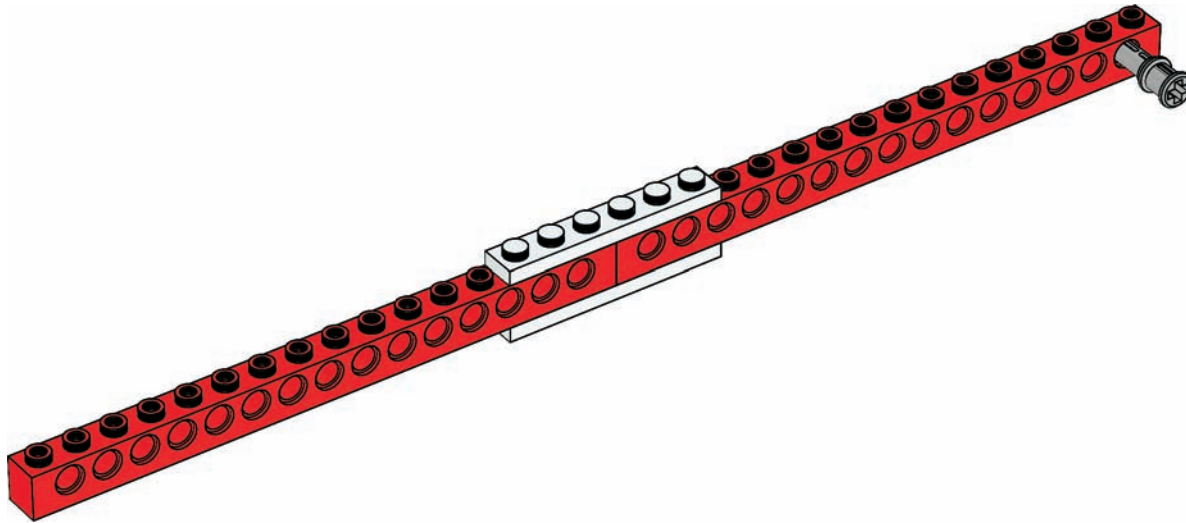

38

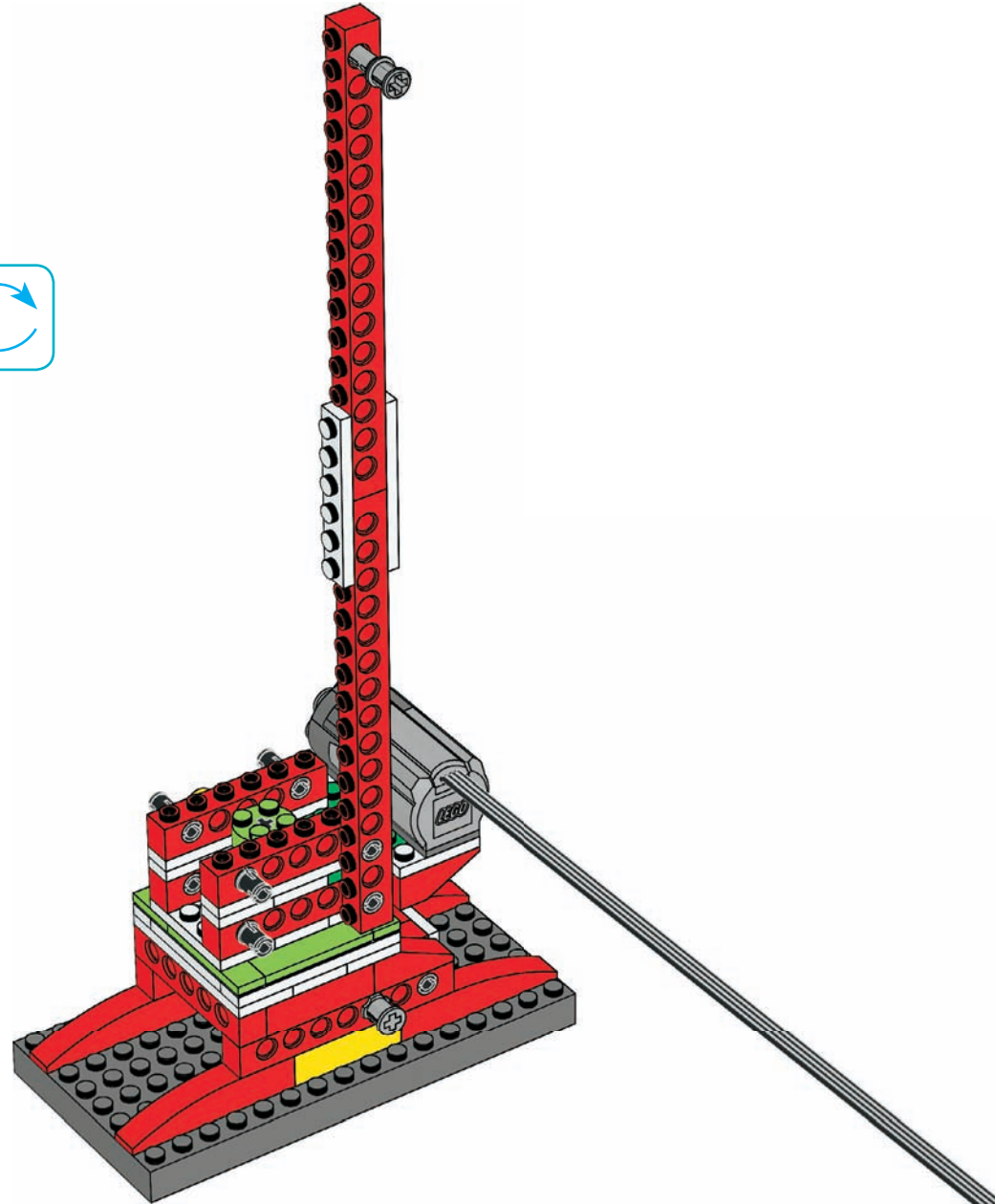

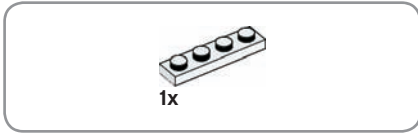

39

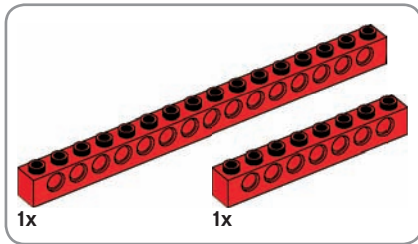

40

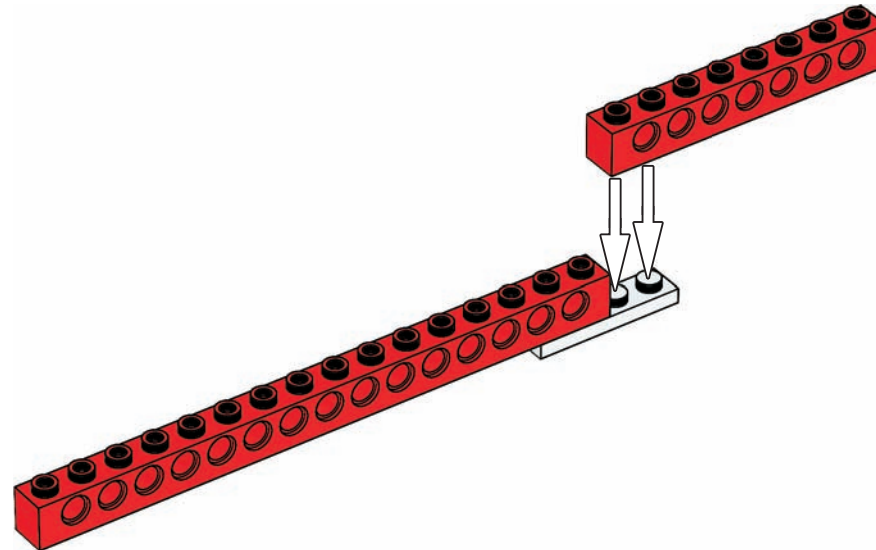

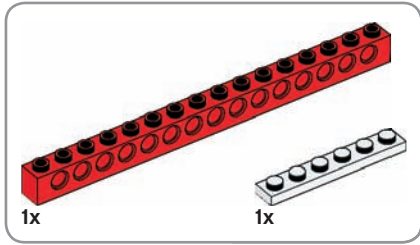

41

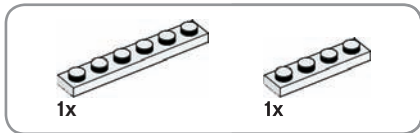
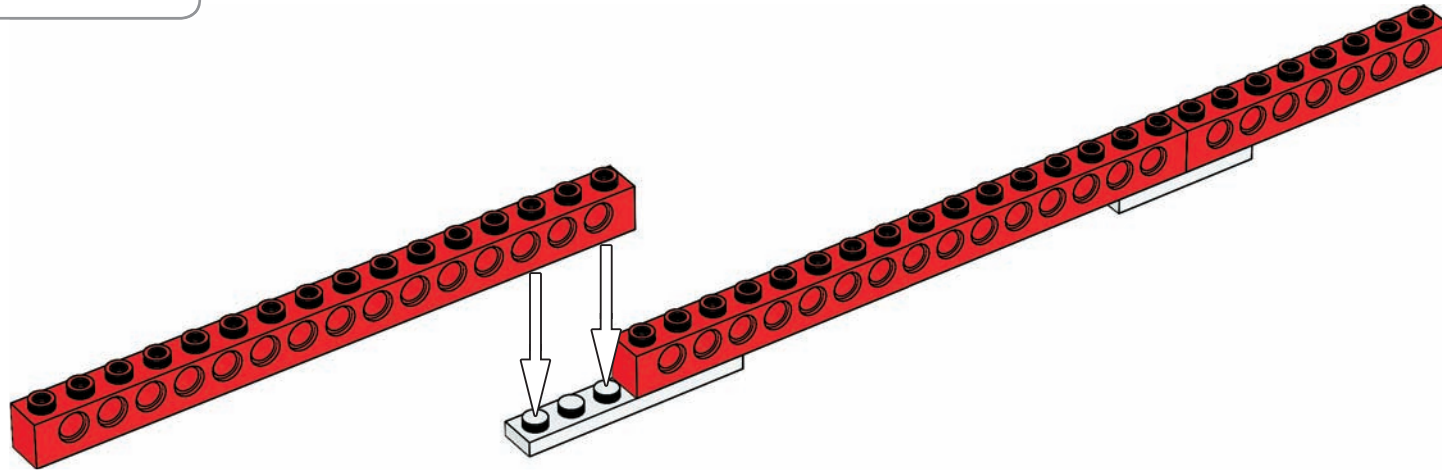

42

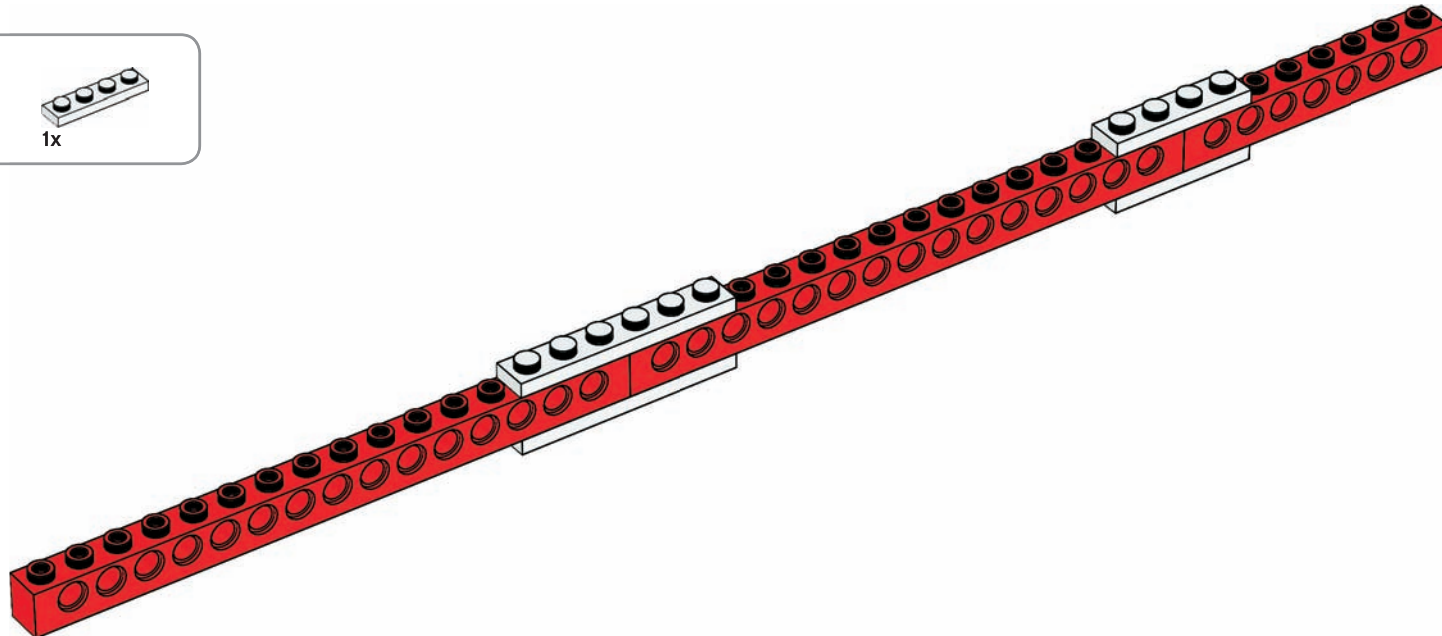





43

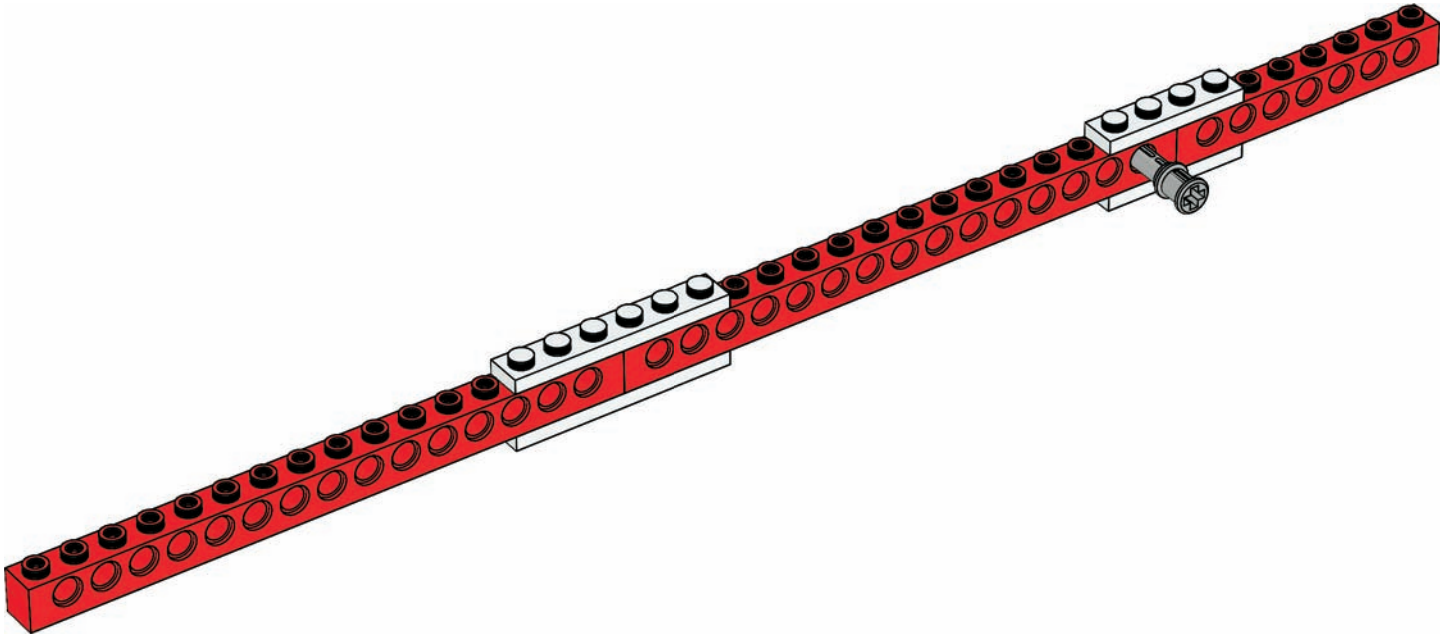

44

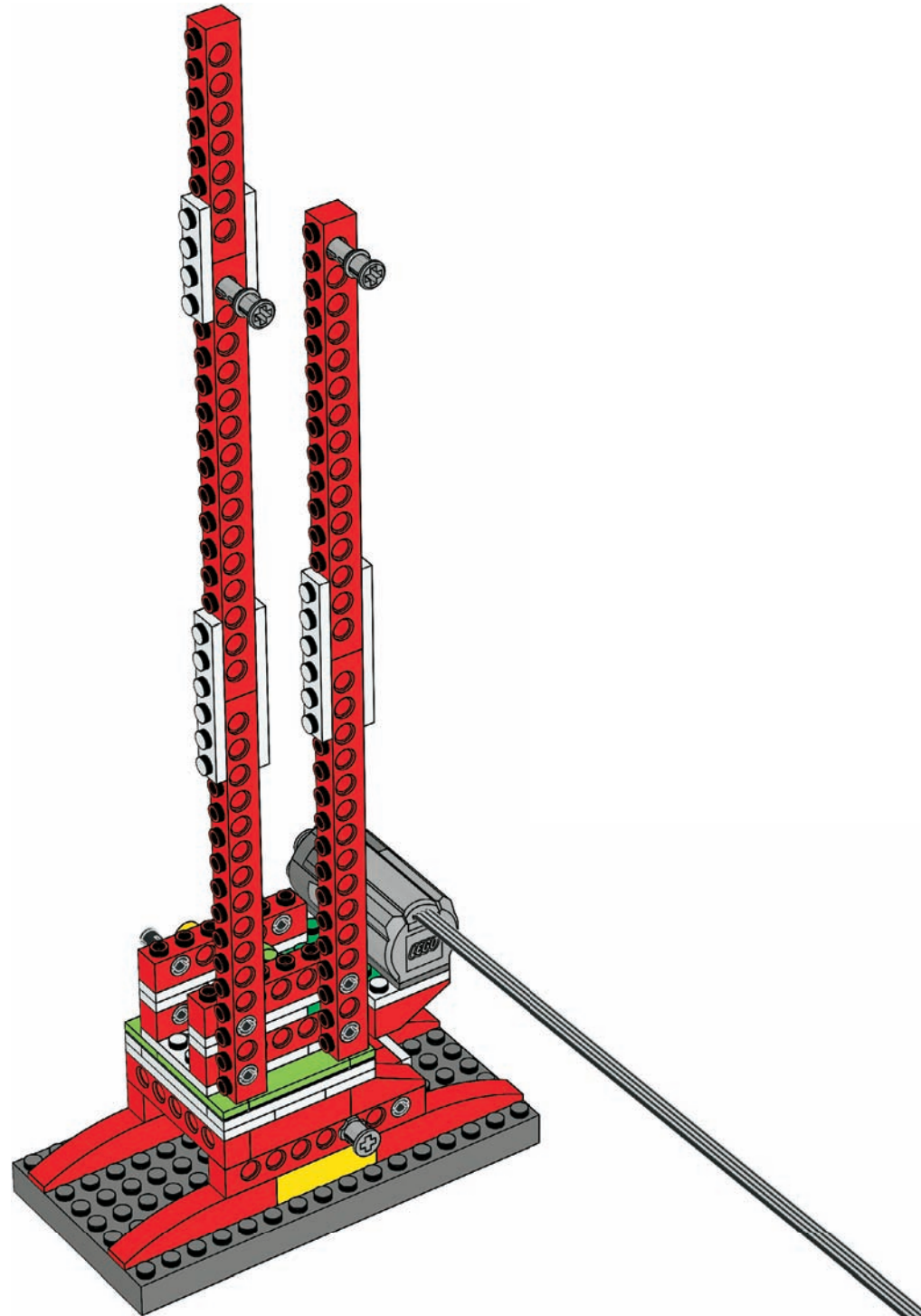

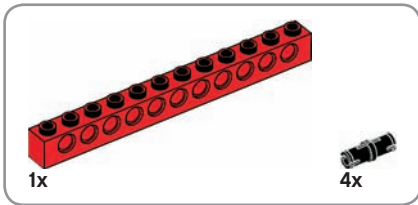
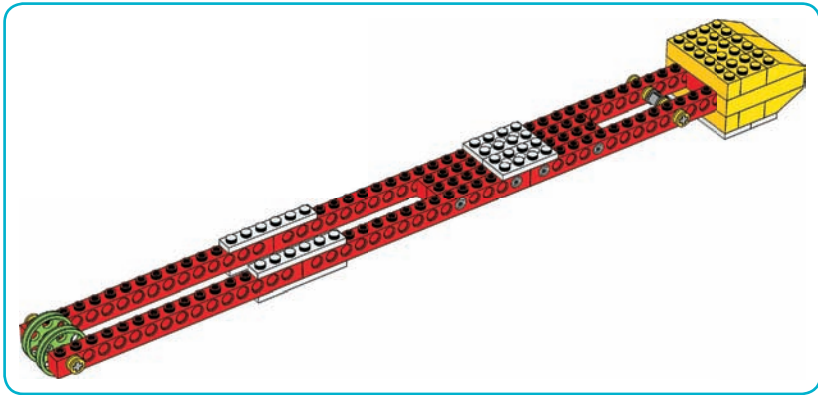

45

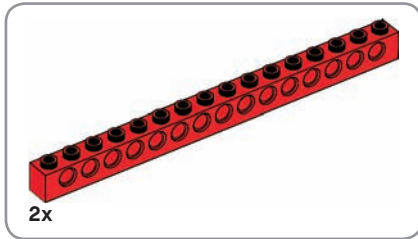
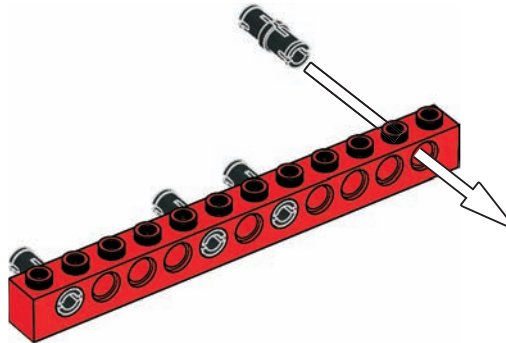

46

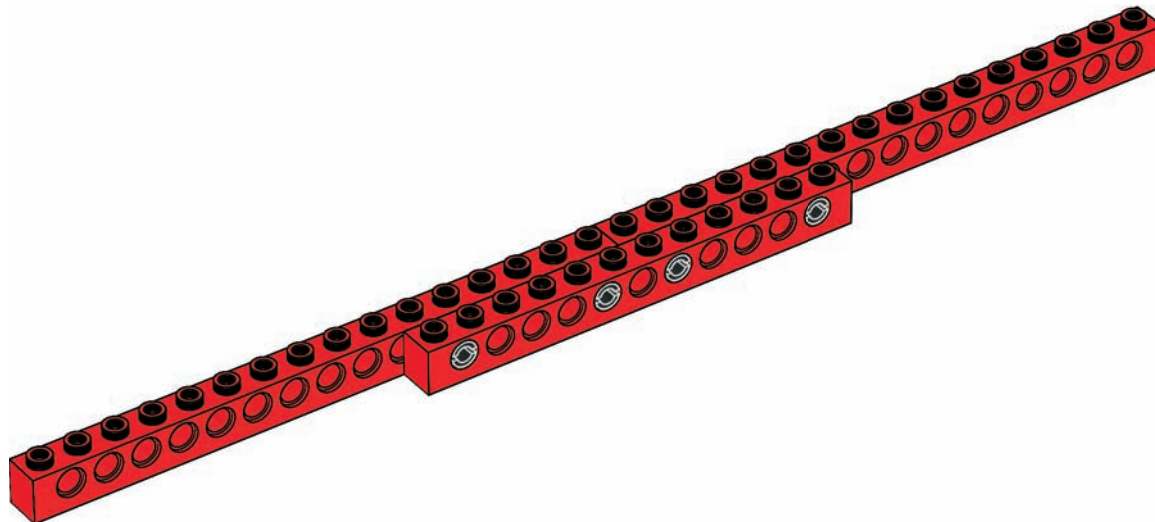

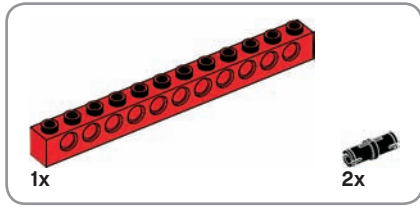

47

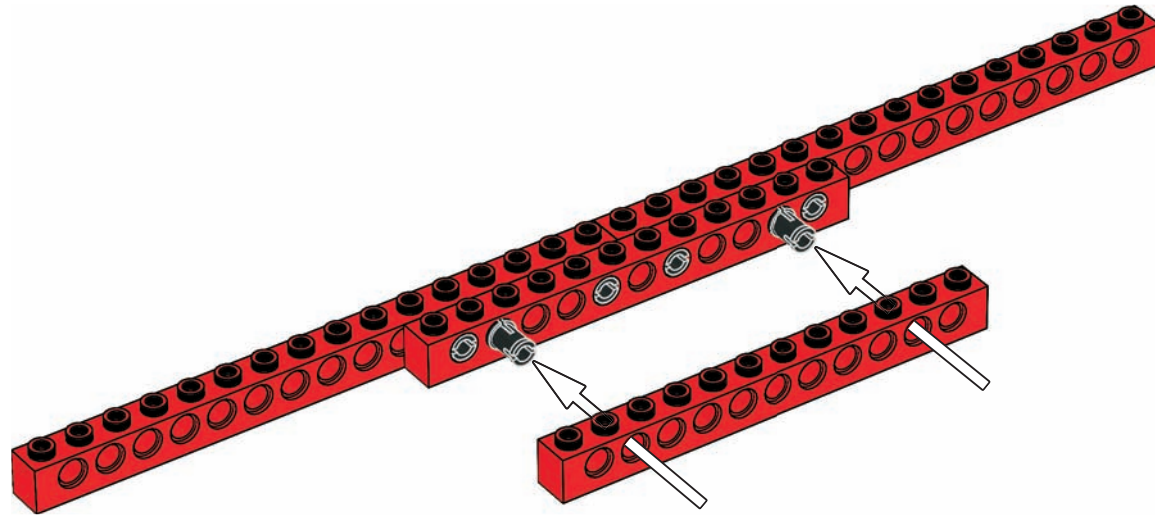

48

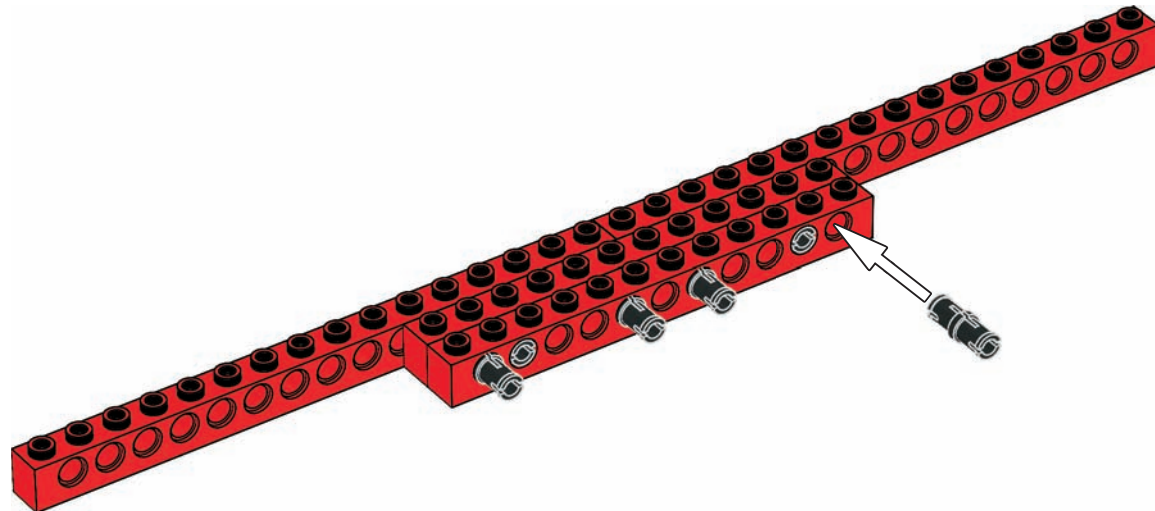

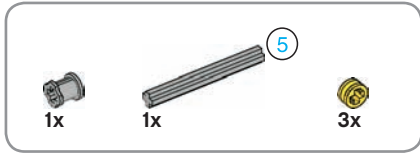

49

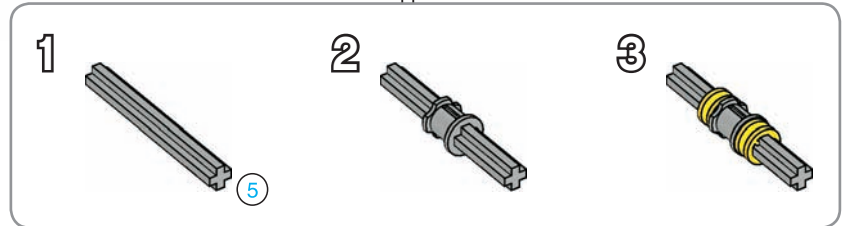
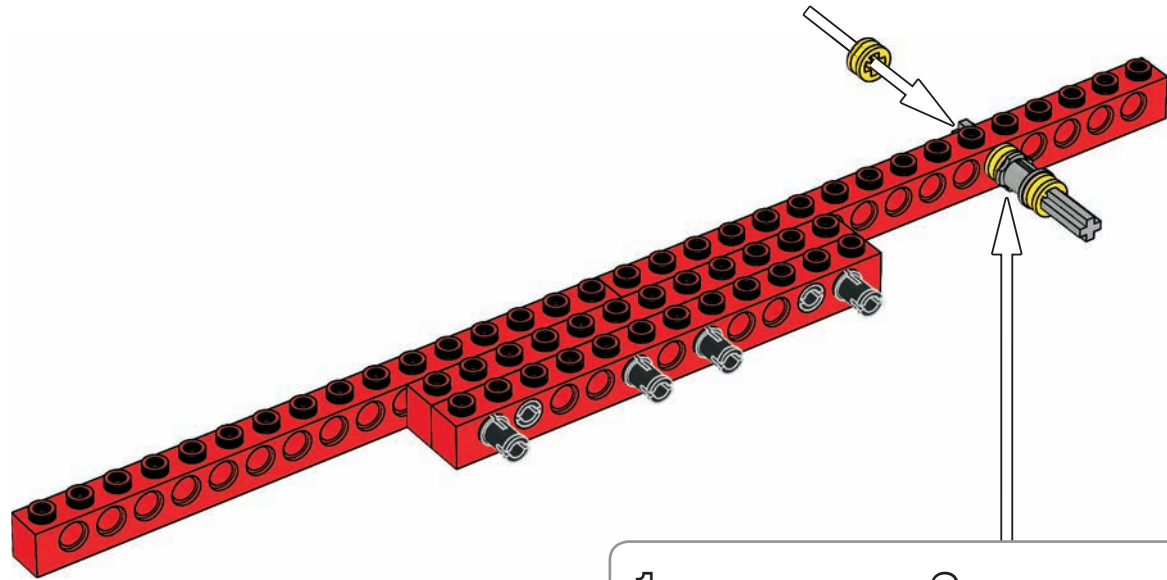

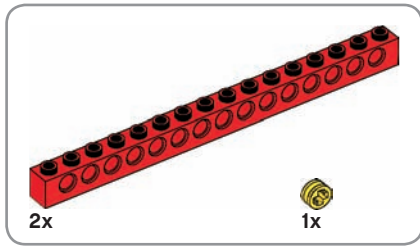

50

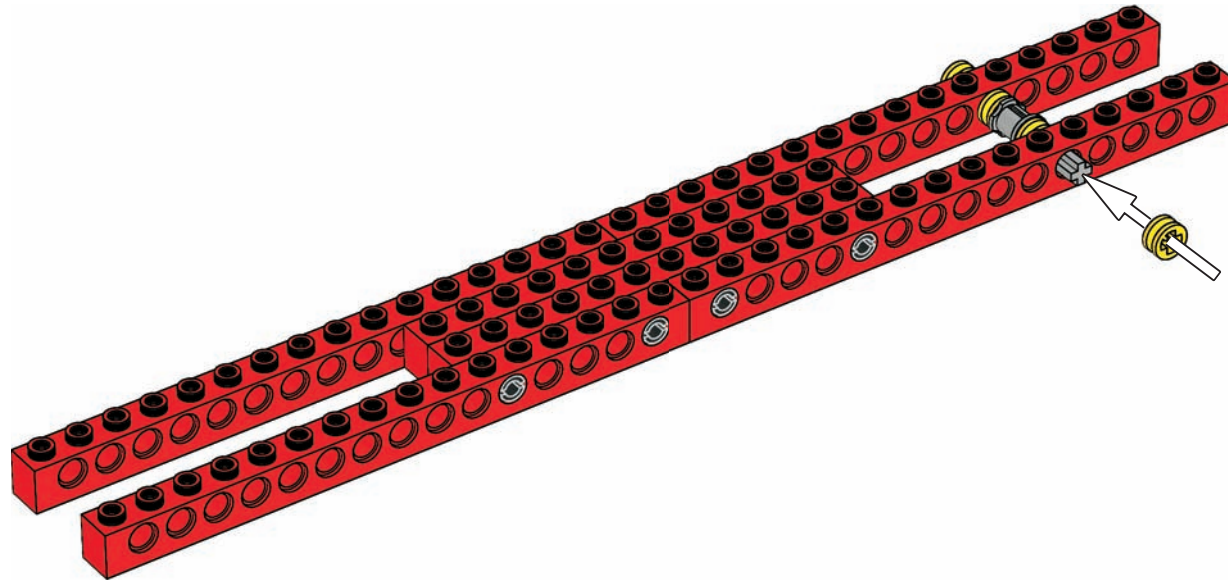

51

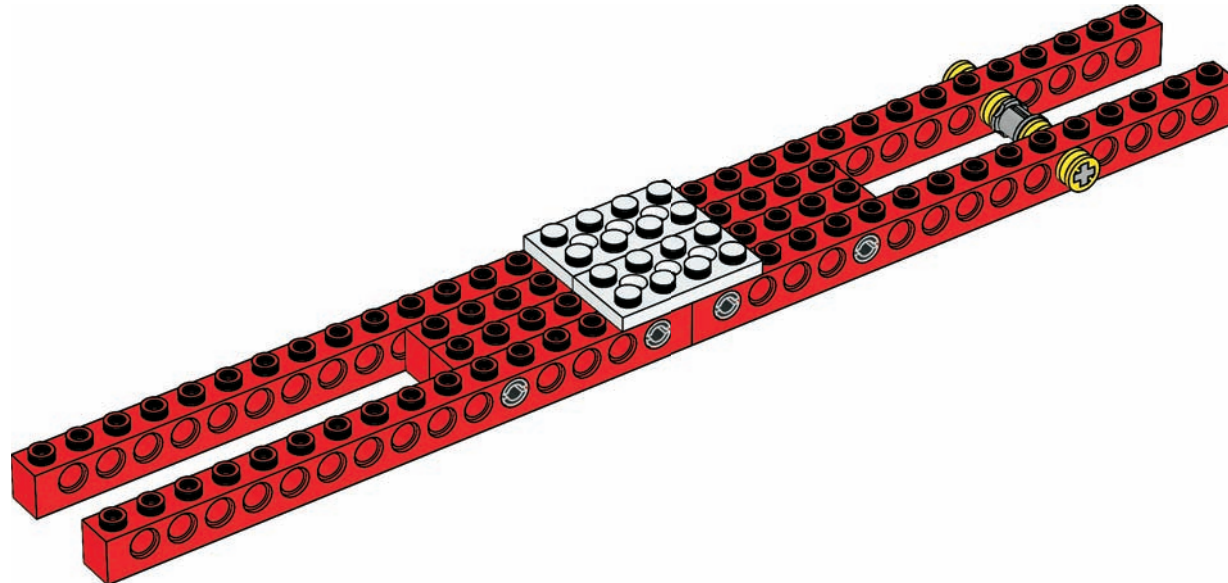



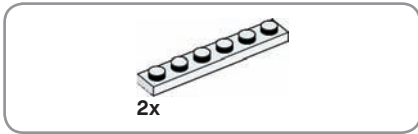

52

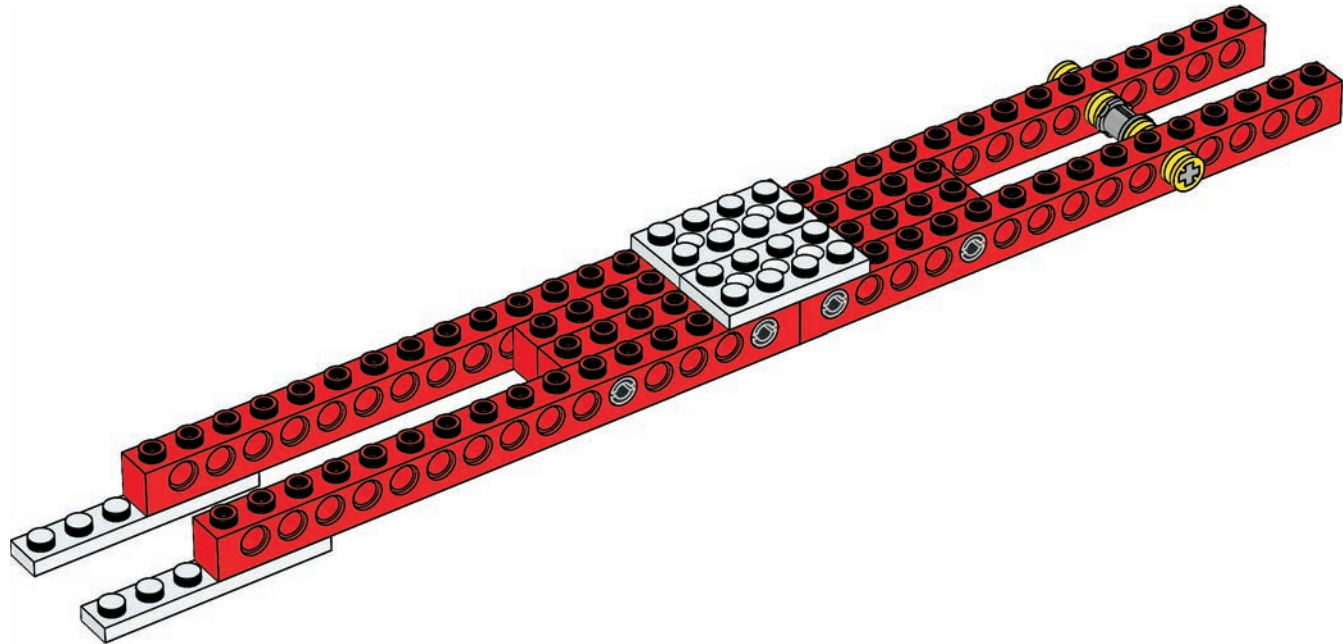



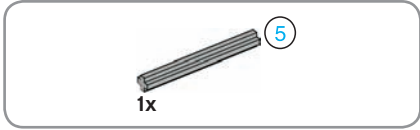
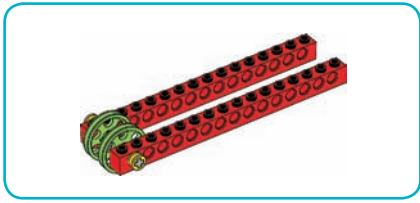

53

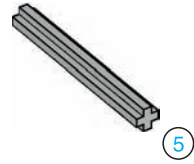

54

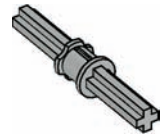

55

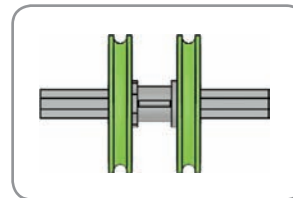
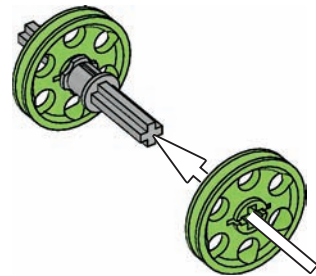

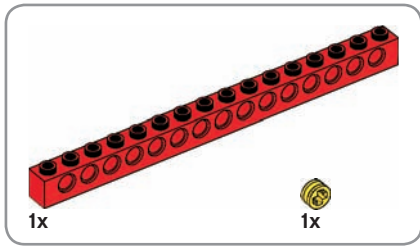

56

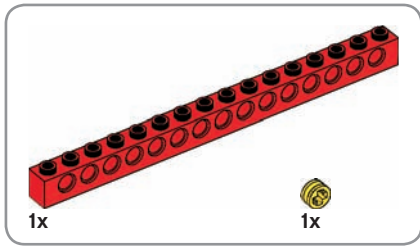
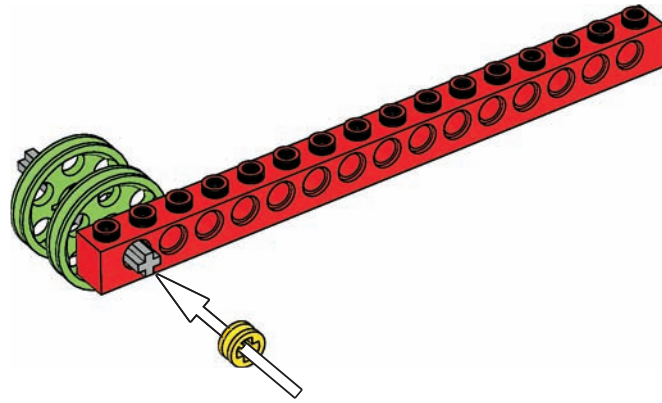

57

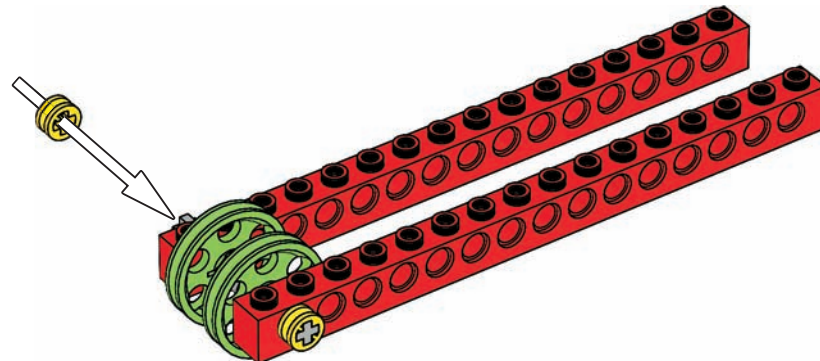

58

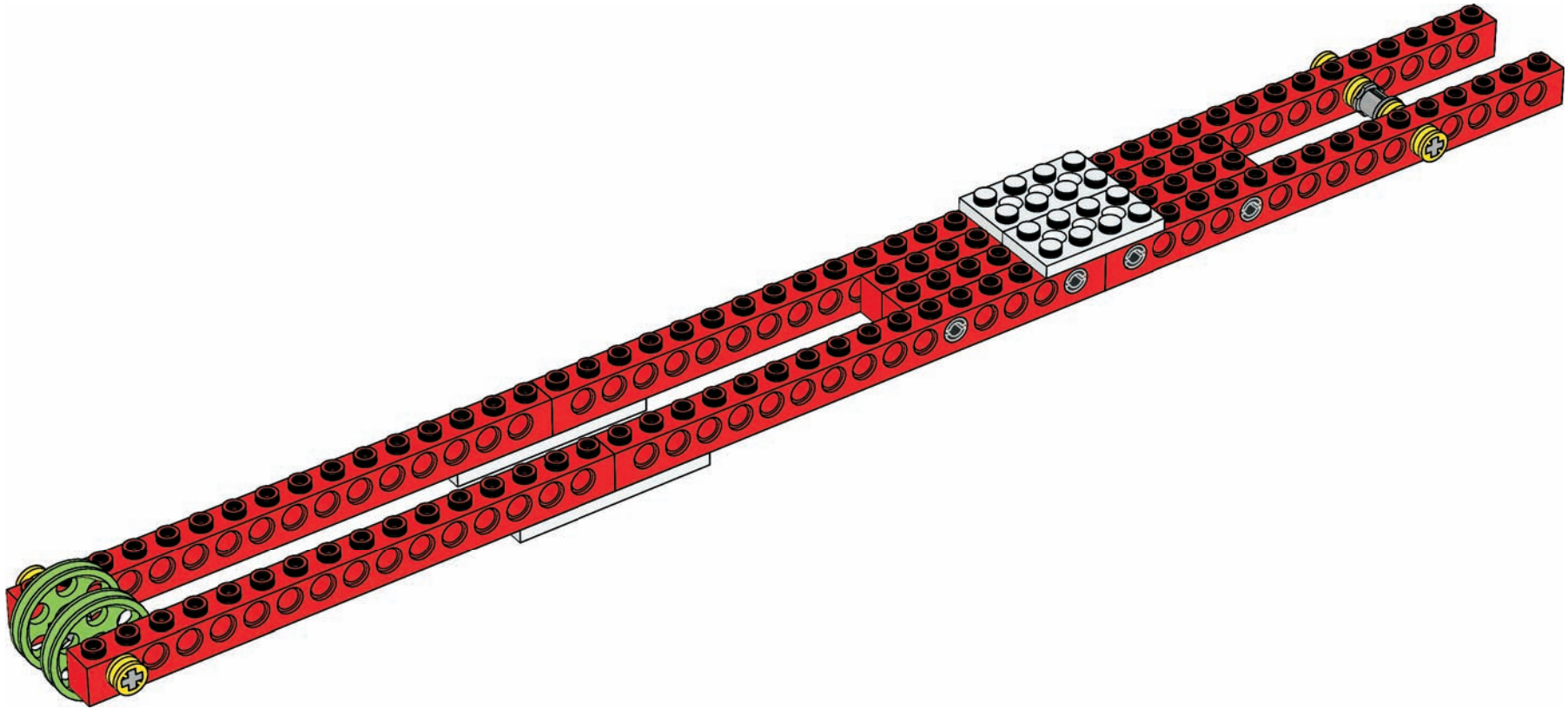

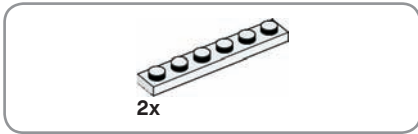

59

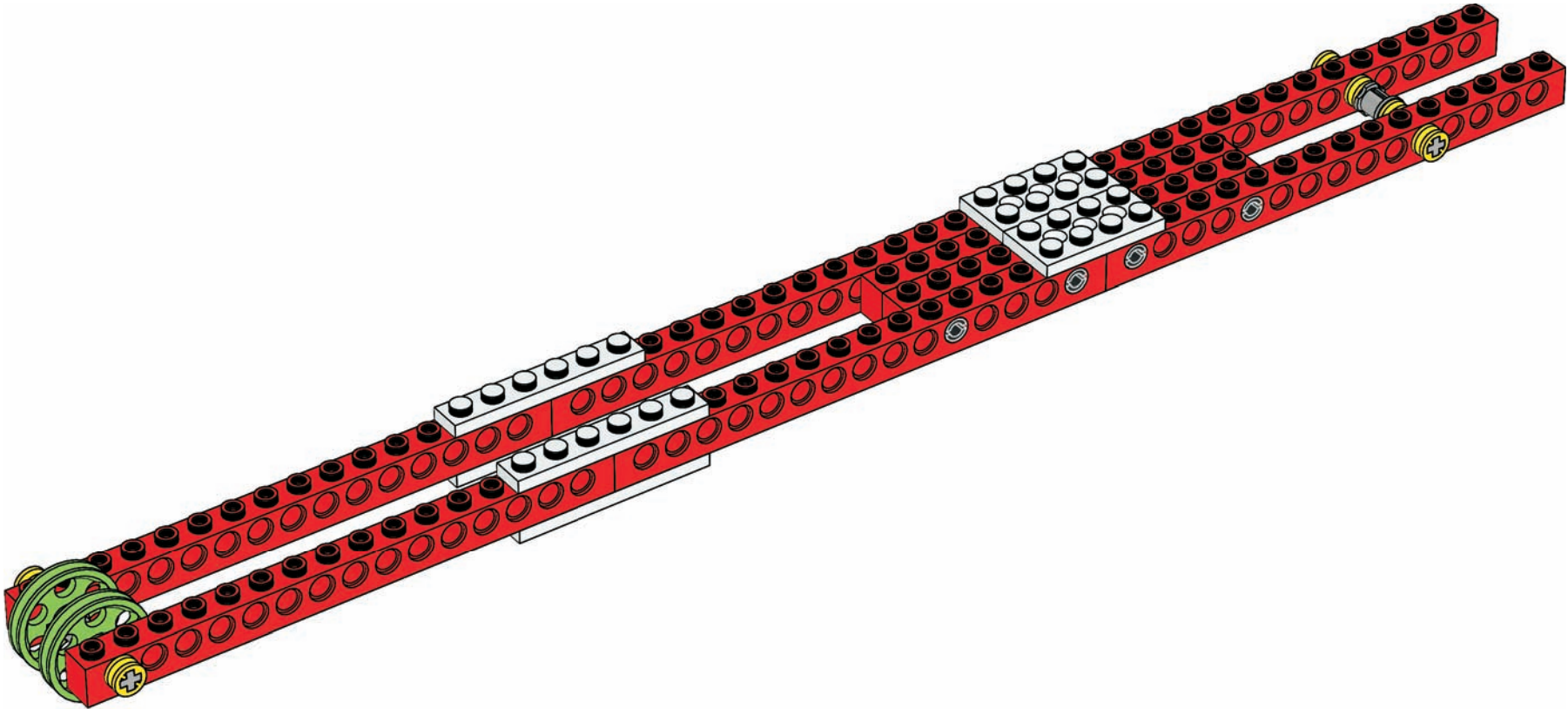

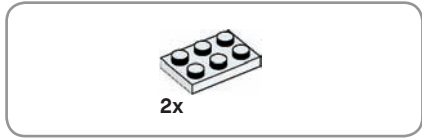
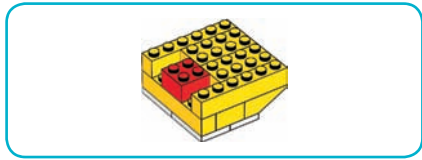

60

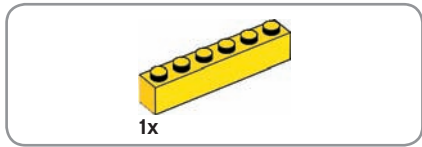
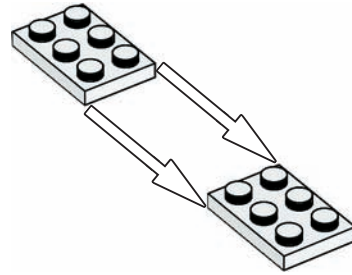

61

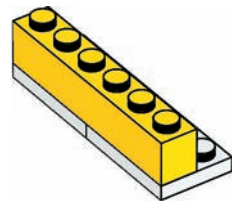





62

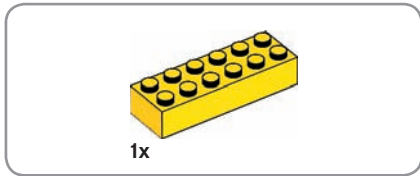
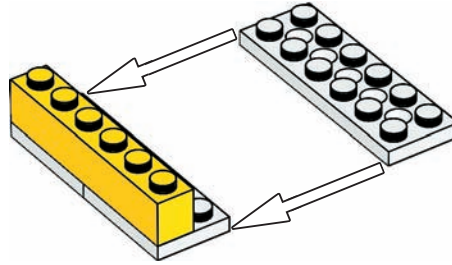

63

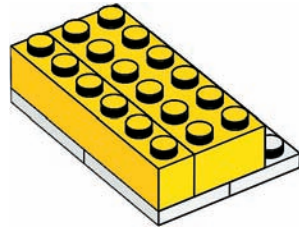



3x

64

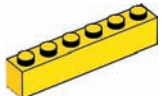
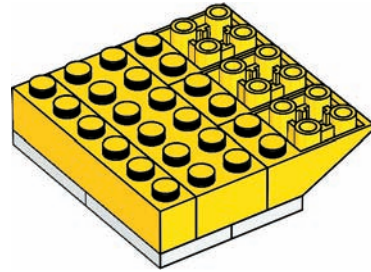

2x

65

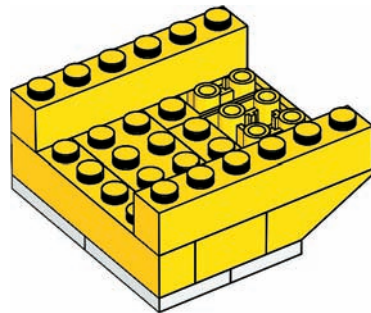

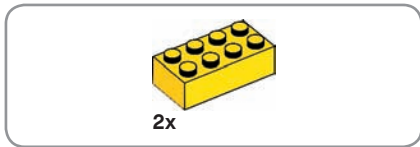

66

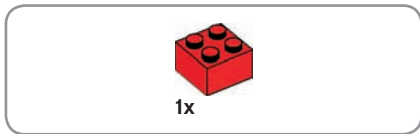
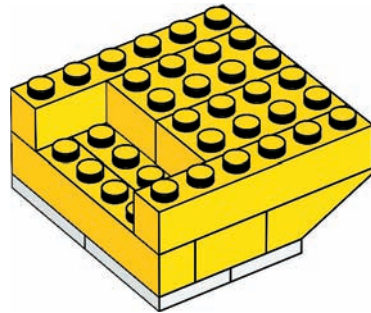

67

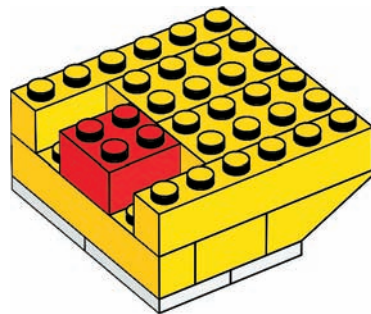

68

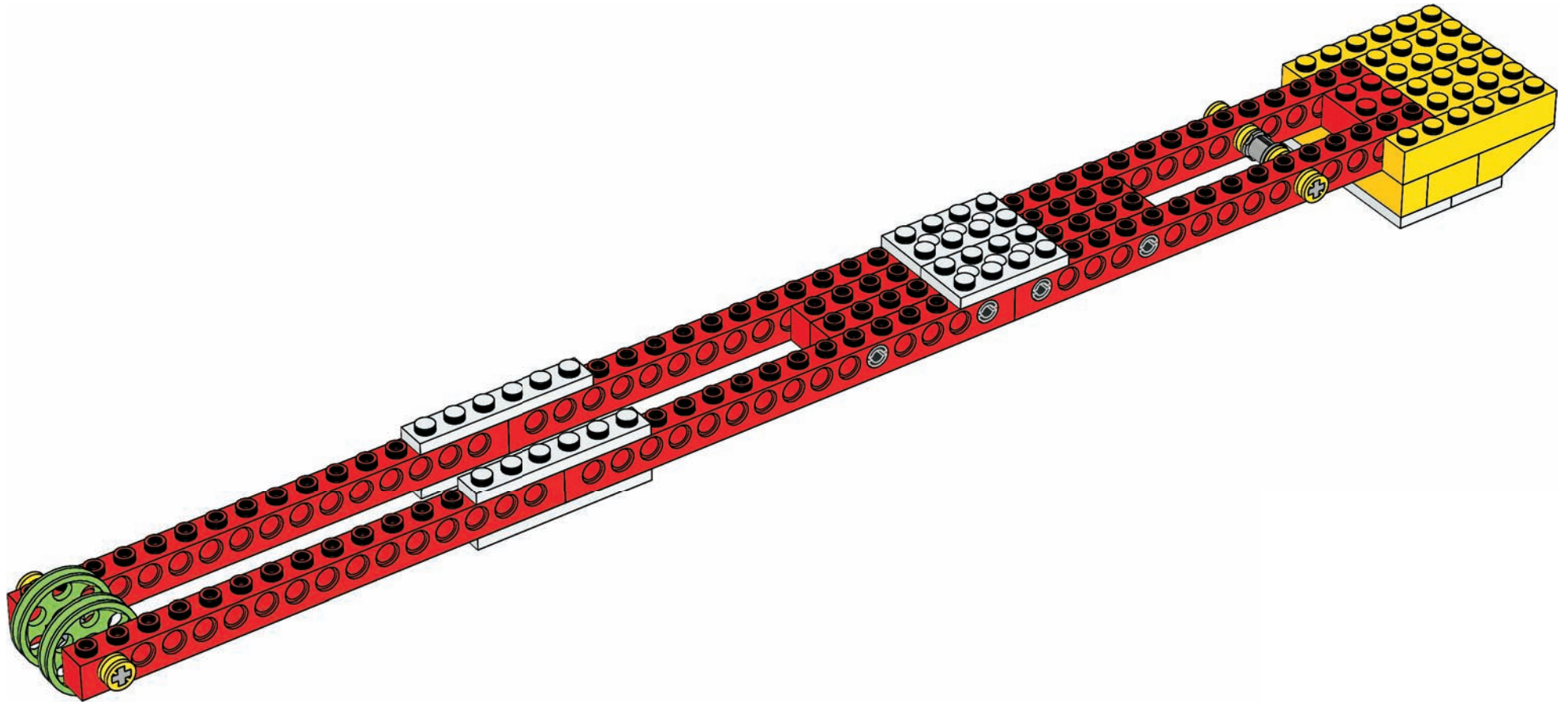

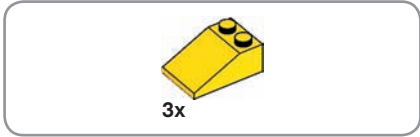

69

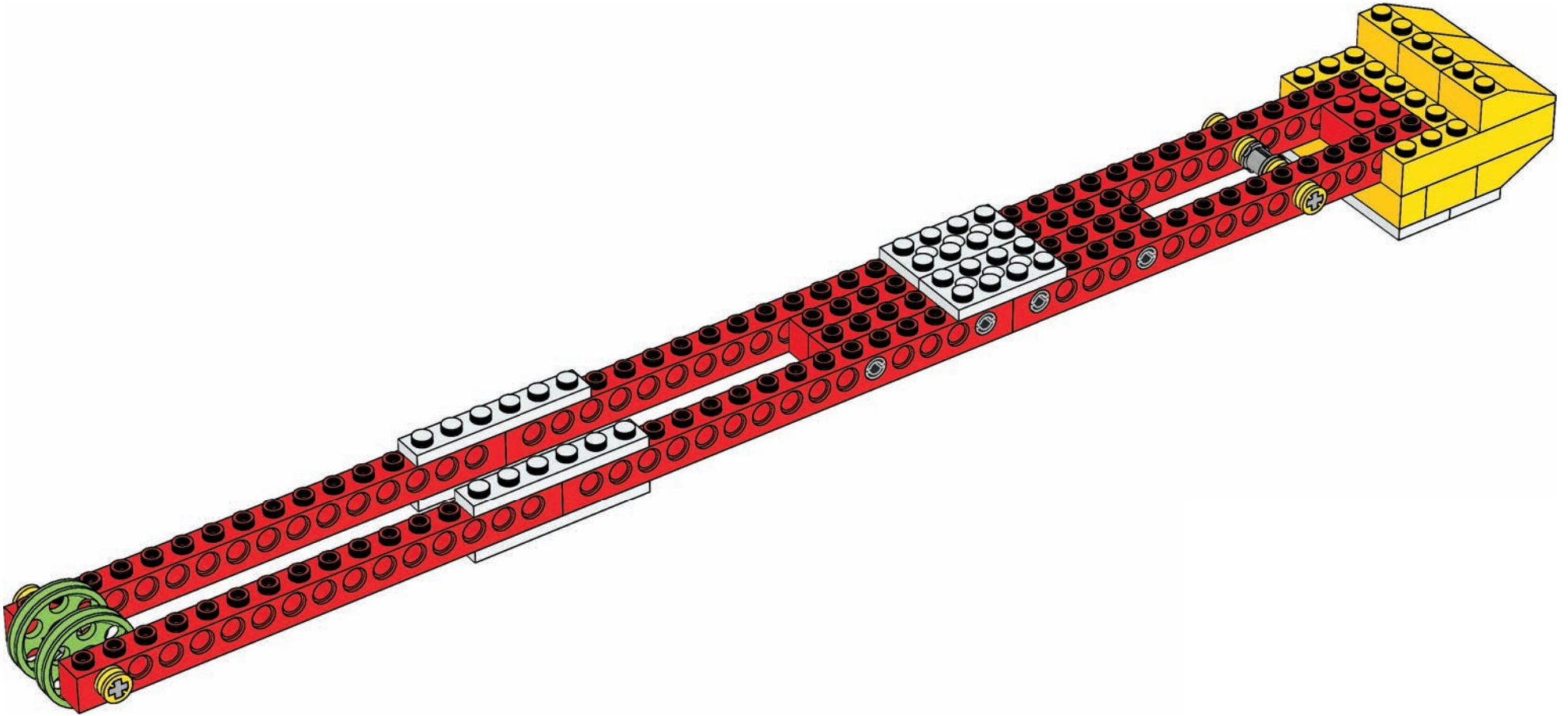



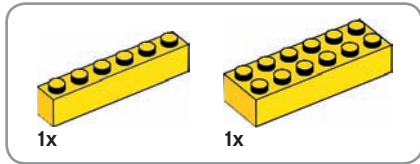

70

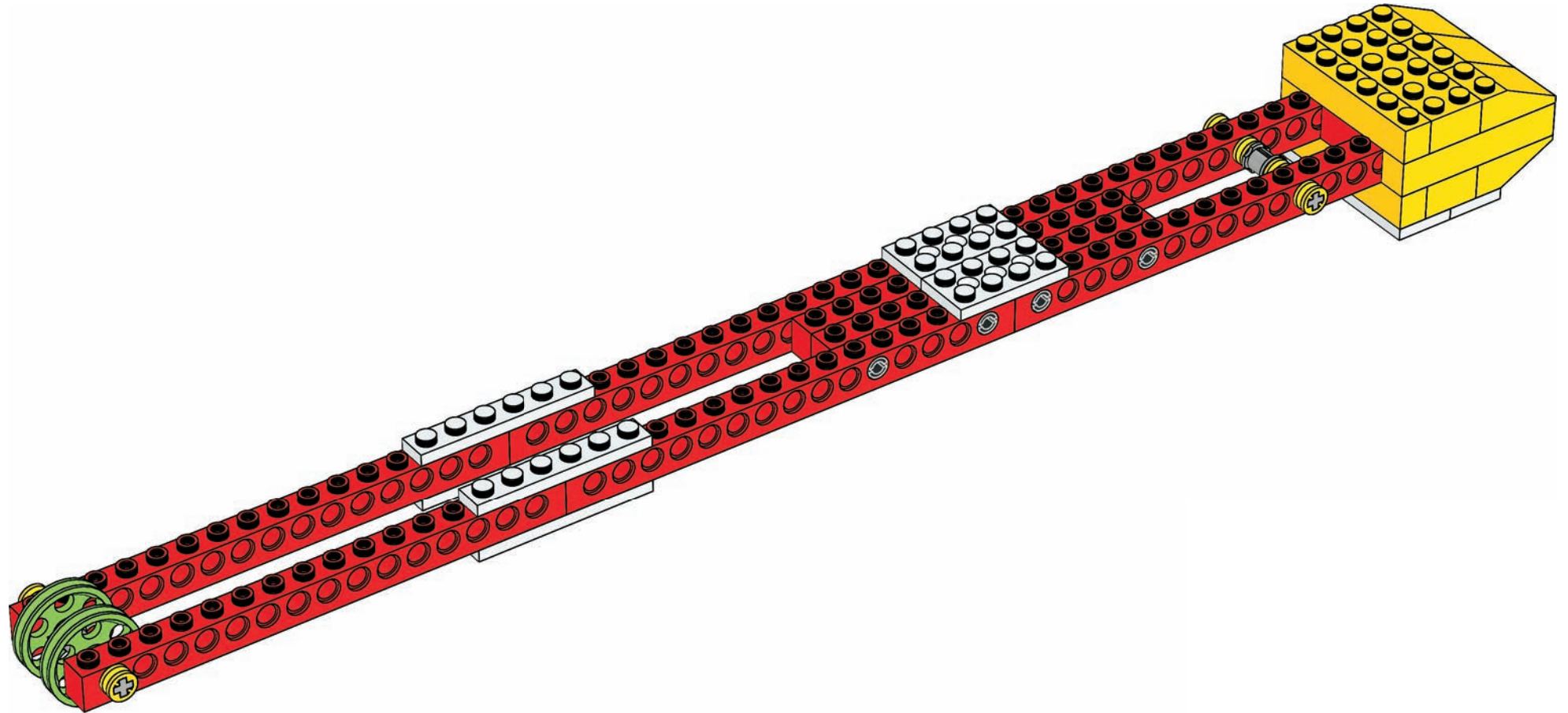

71

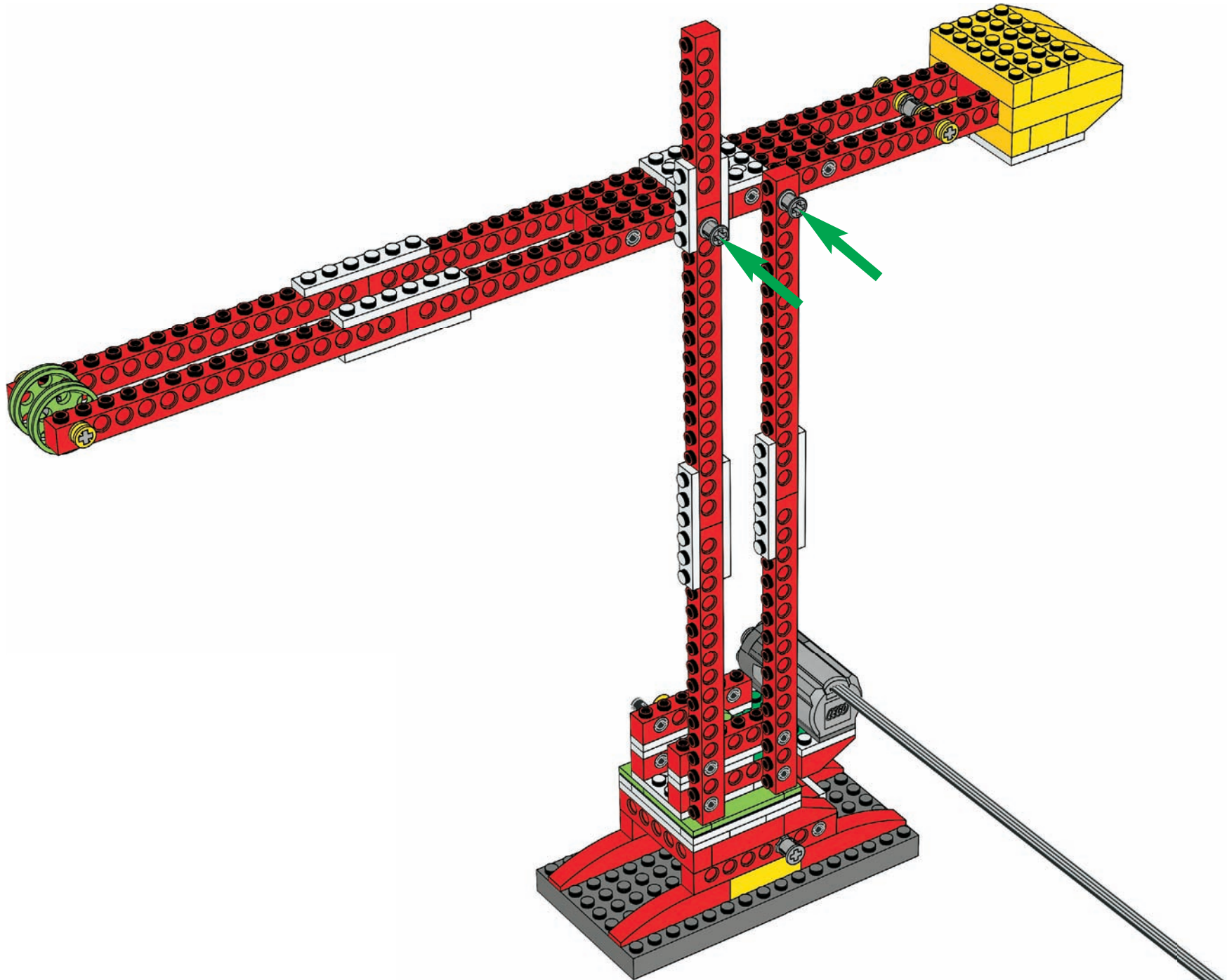

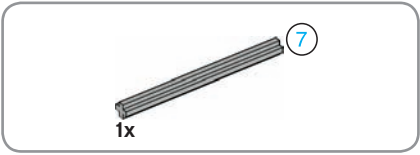

72

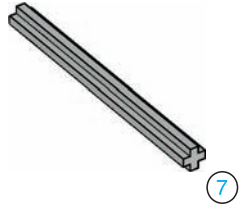

73

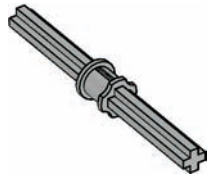

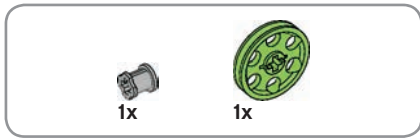

74

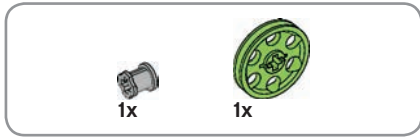
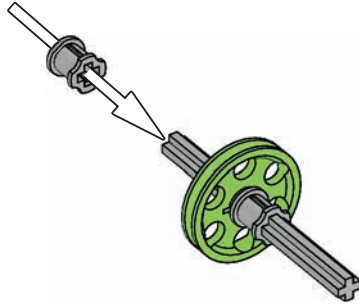

75

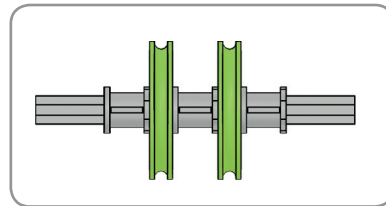
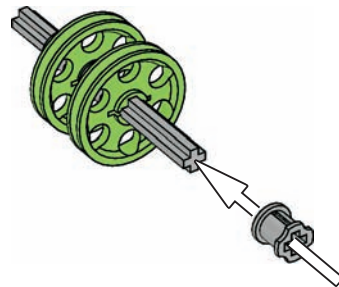



1x

76

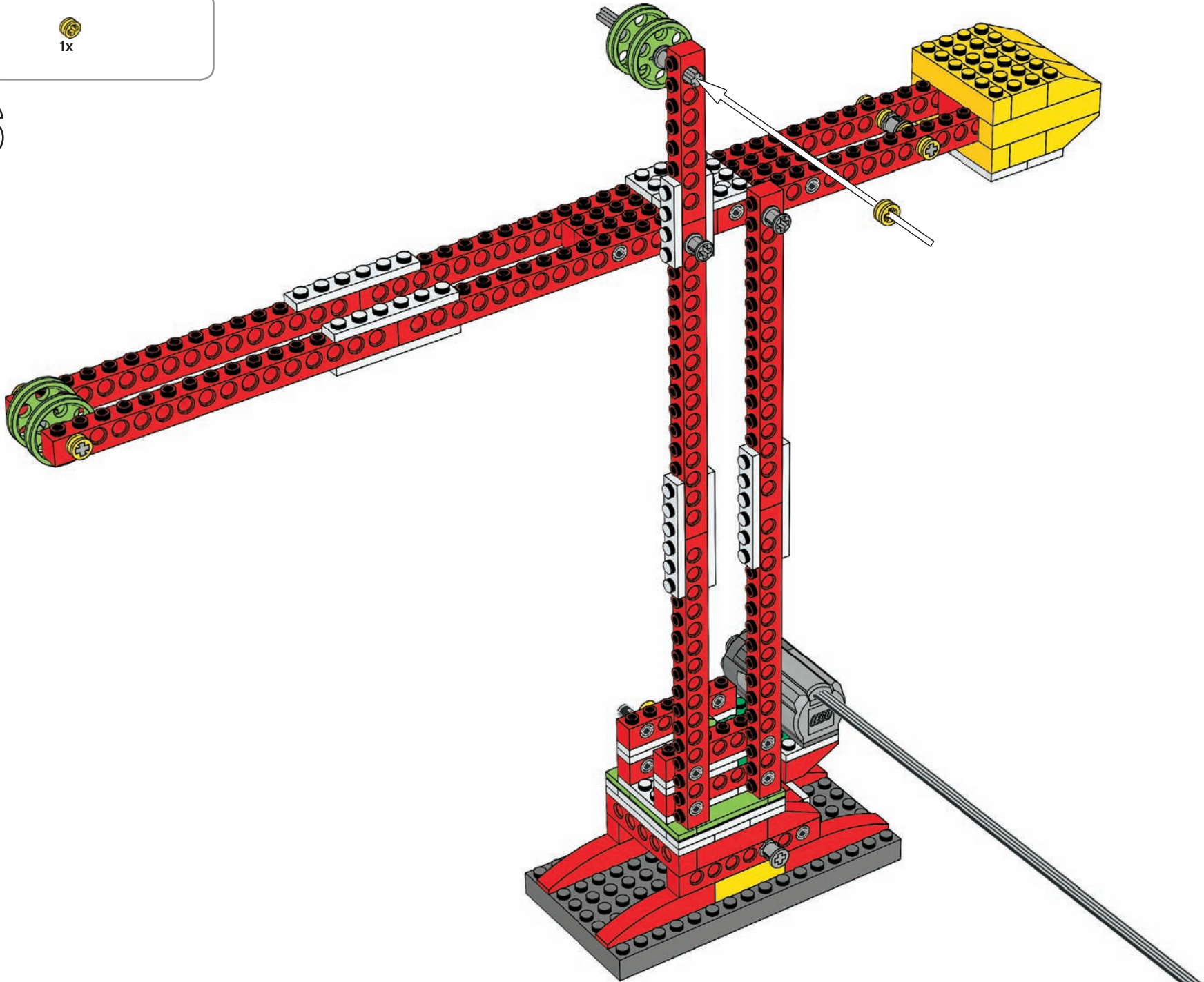



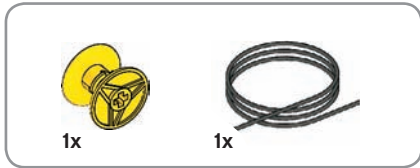
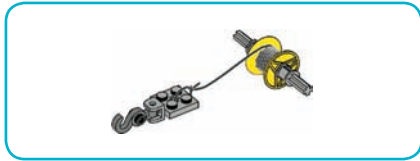

77

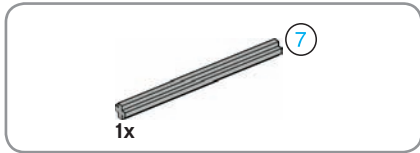

78

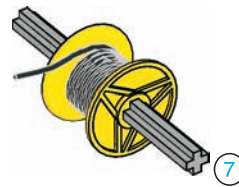

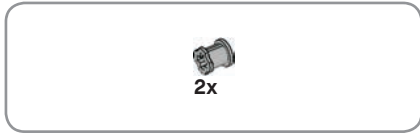

79

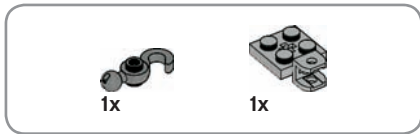
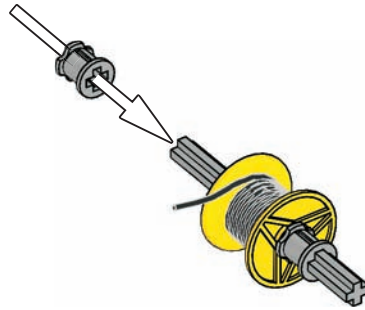

80

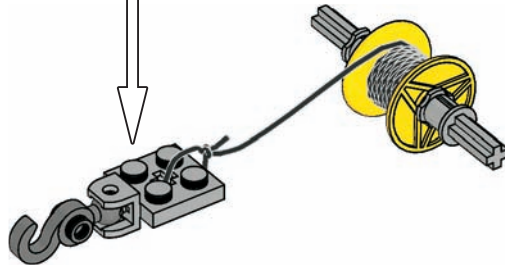
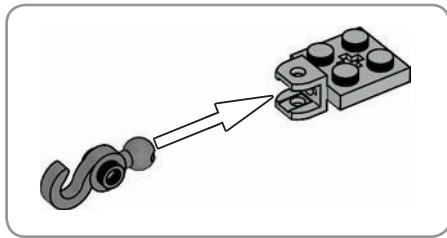



1x

81

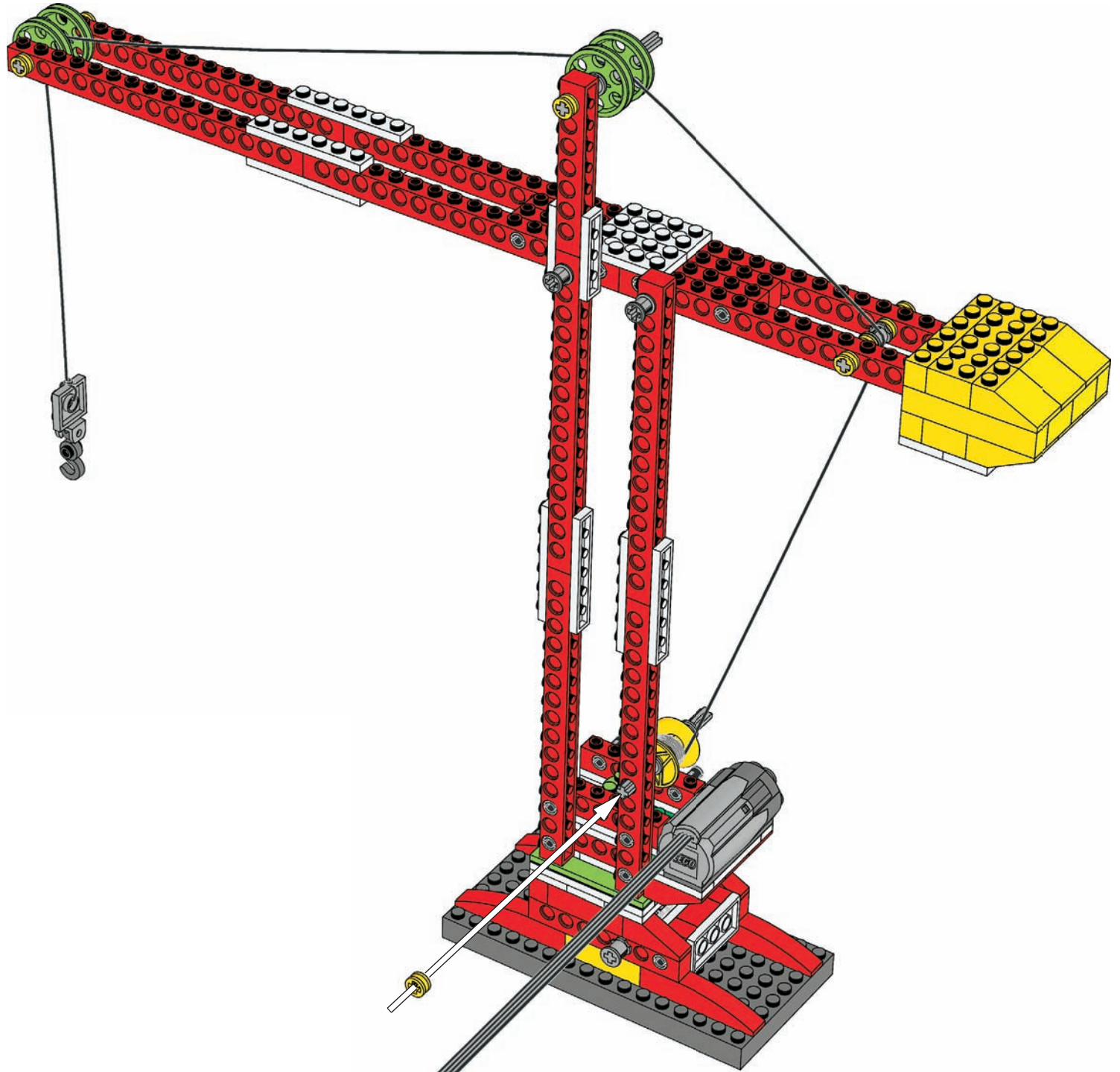

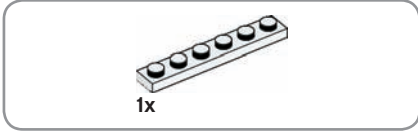

82

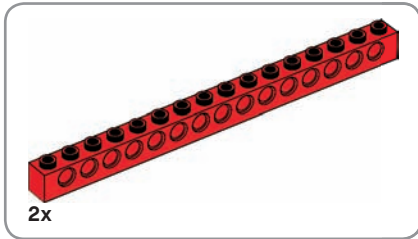
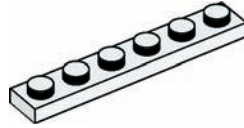

83

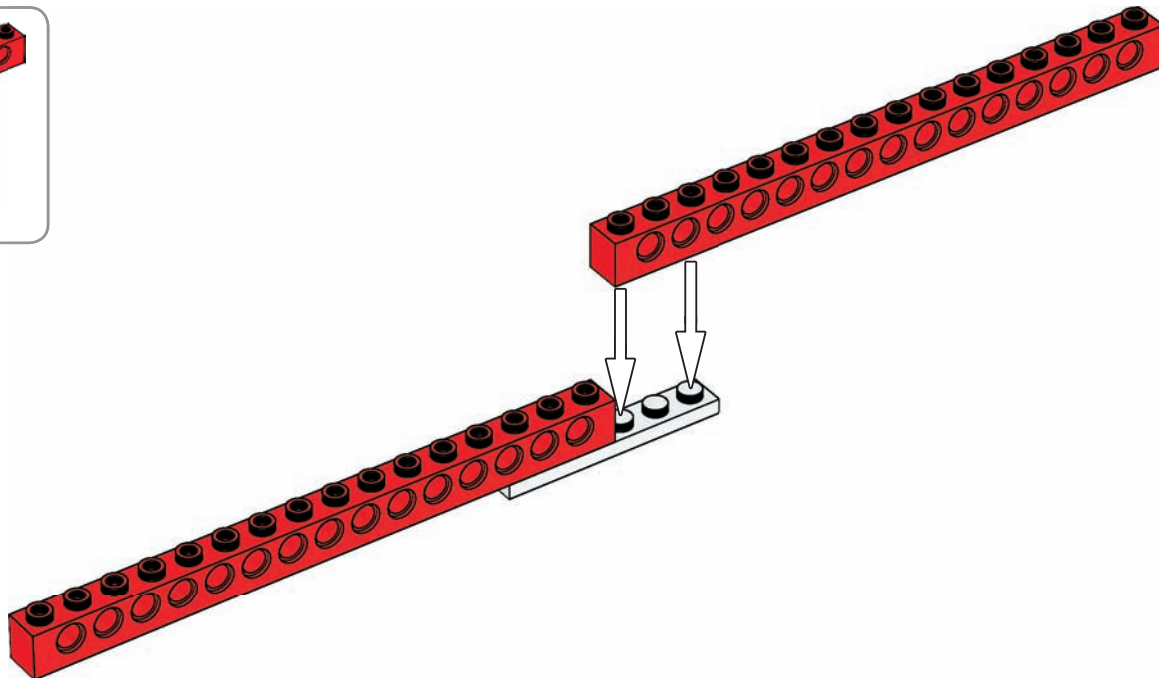

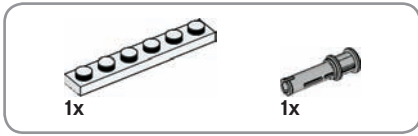

84

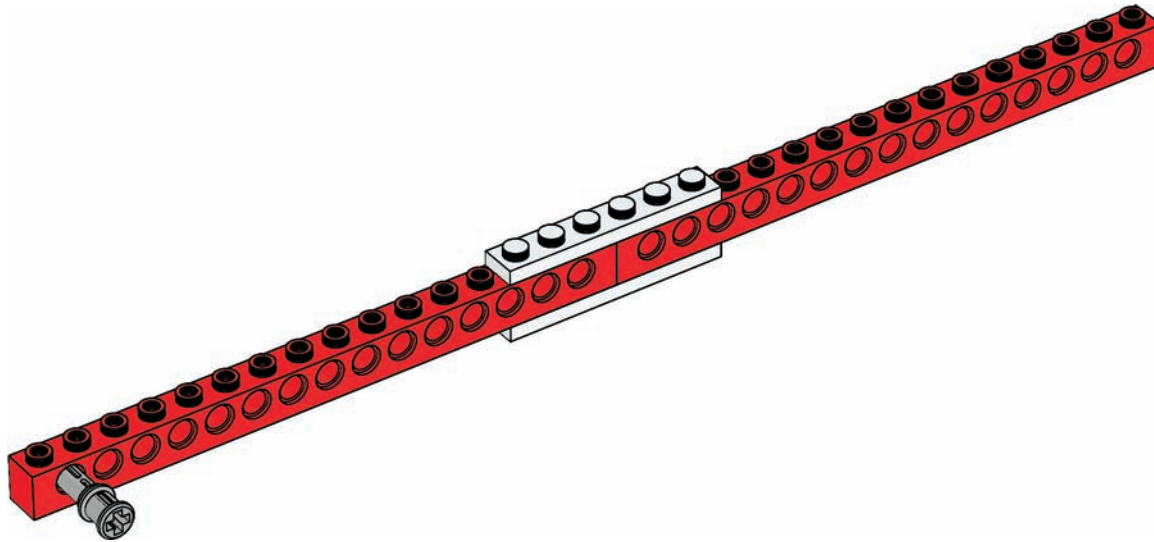



85



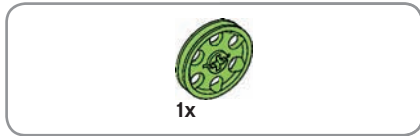

86



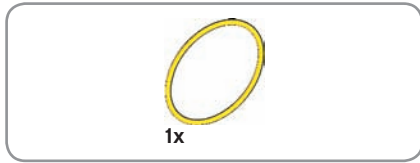

87





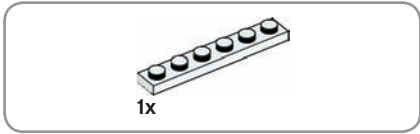
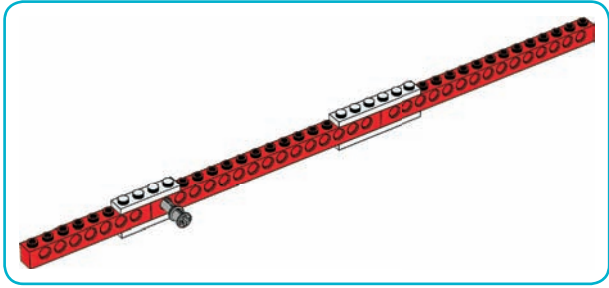

88

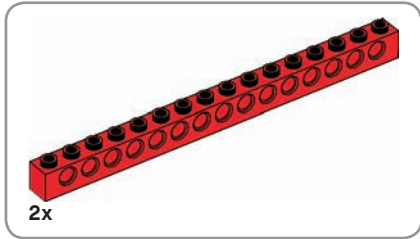
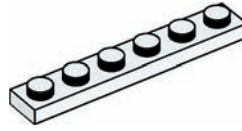

89

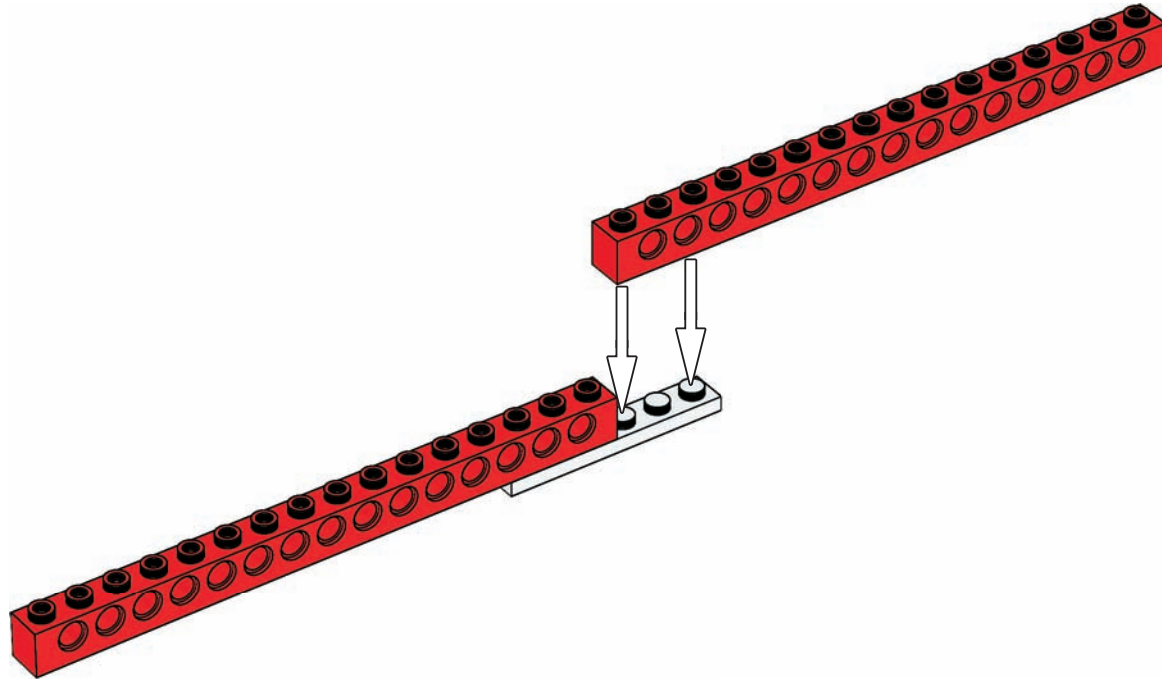

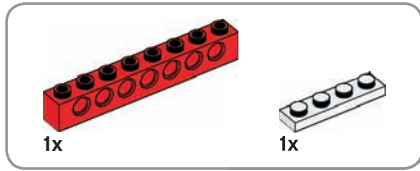

90

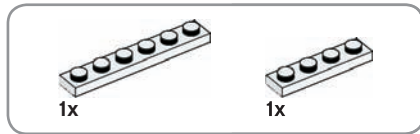
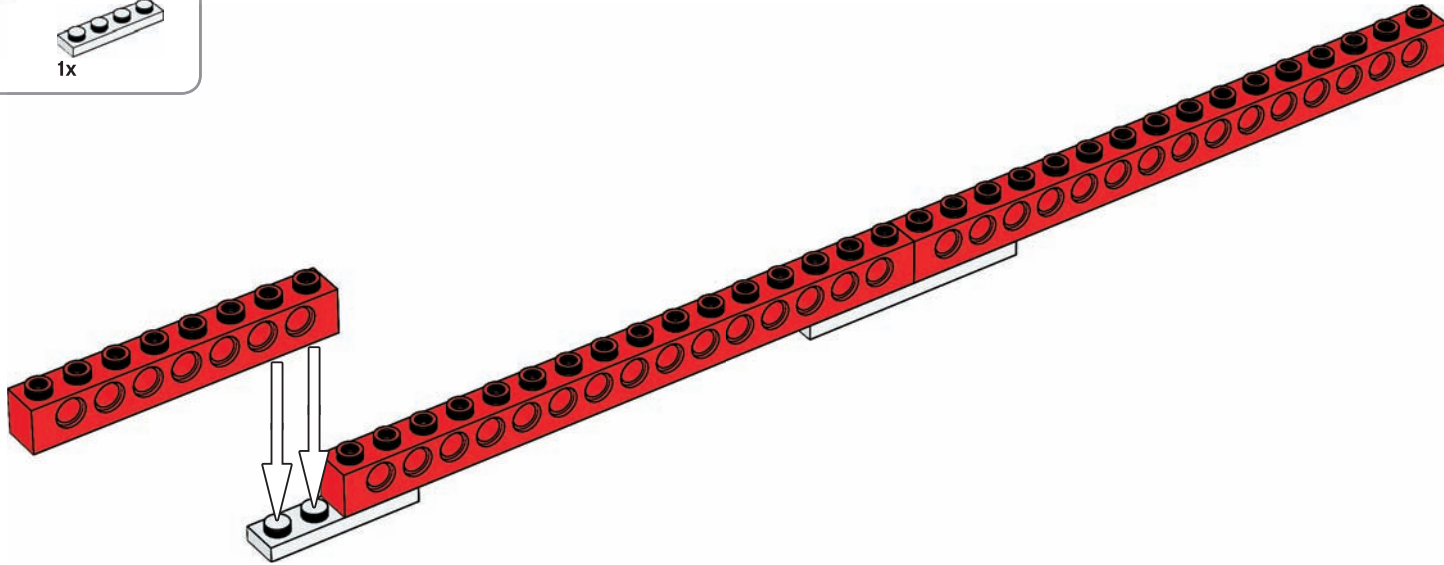

91

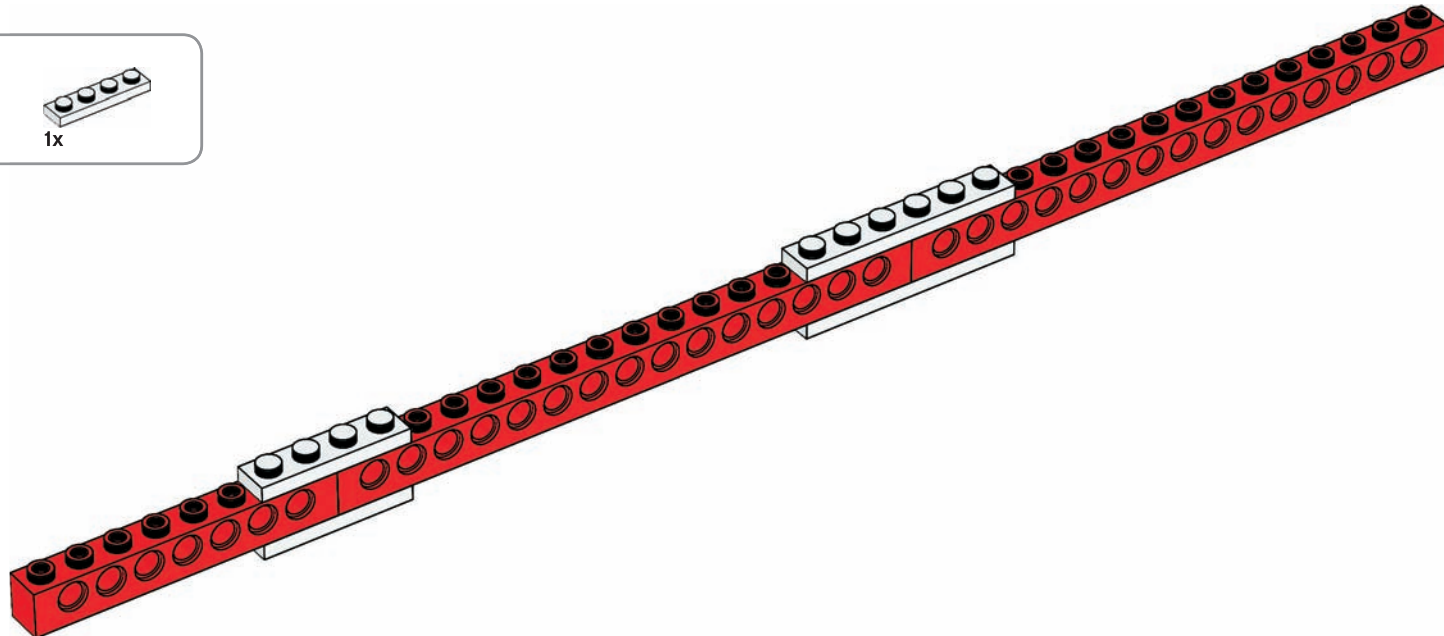



92

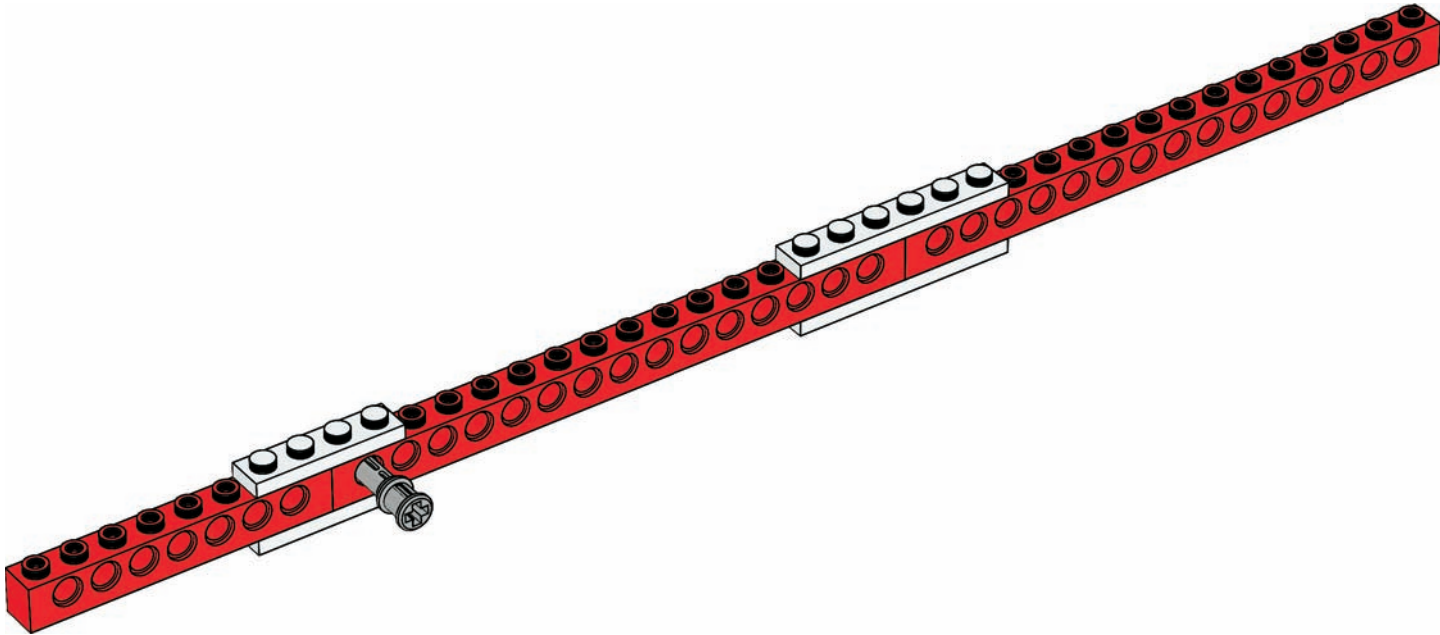



93

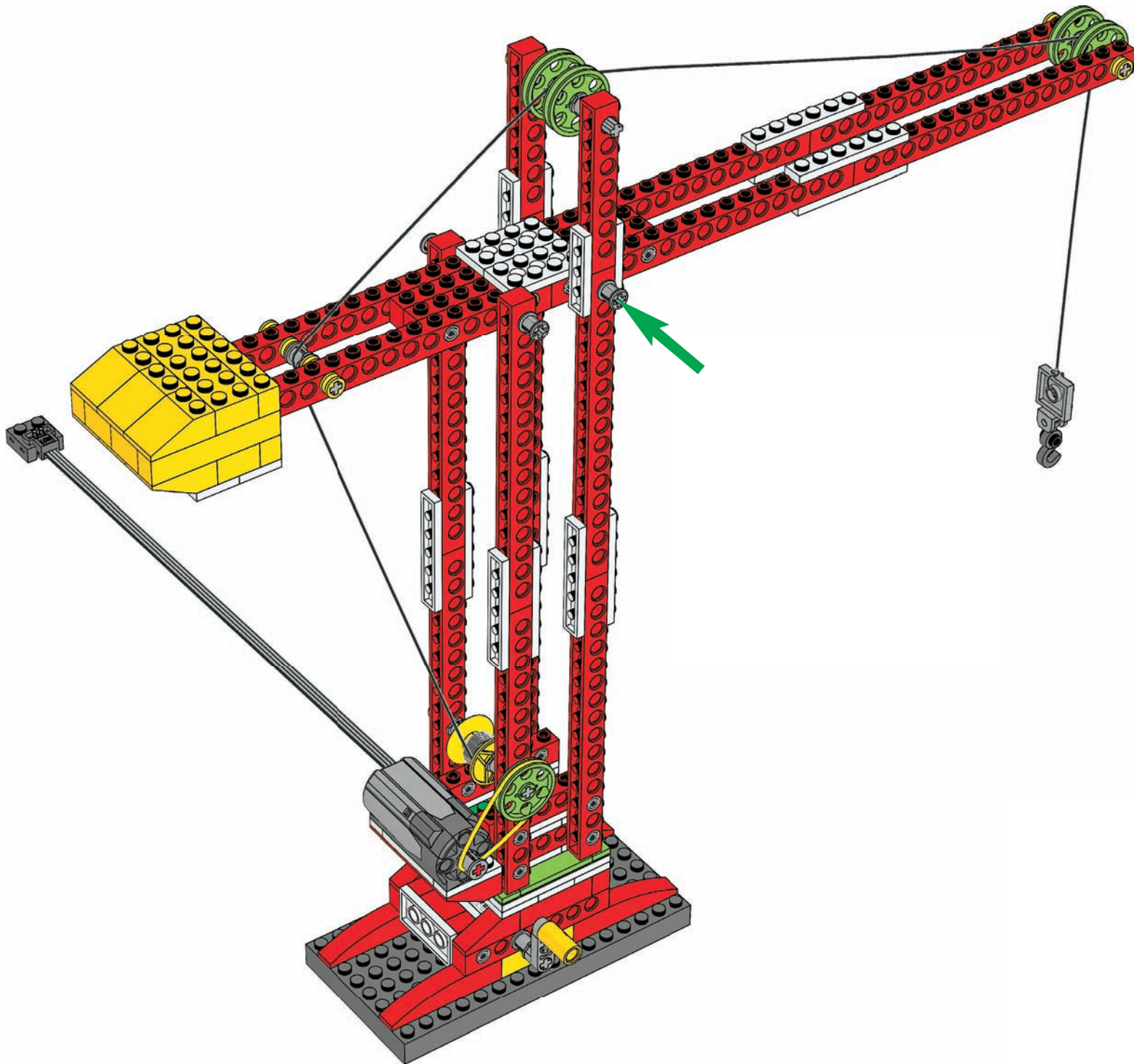

1x

94



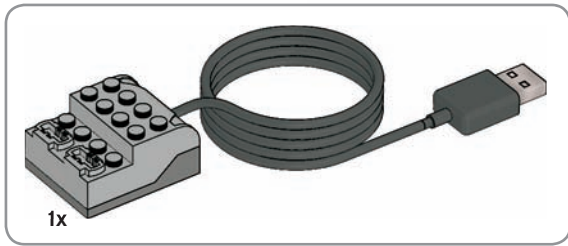

95

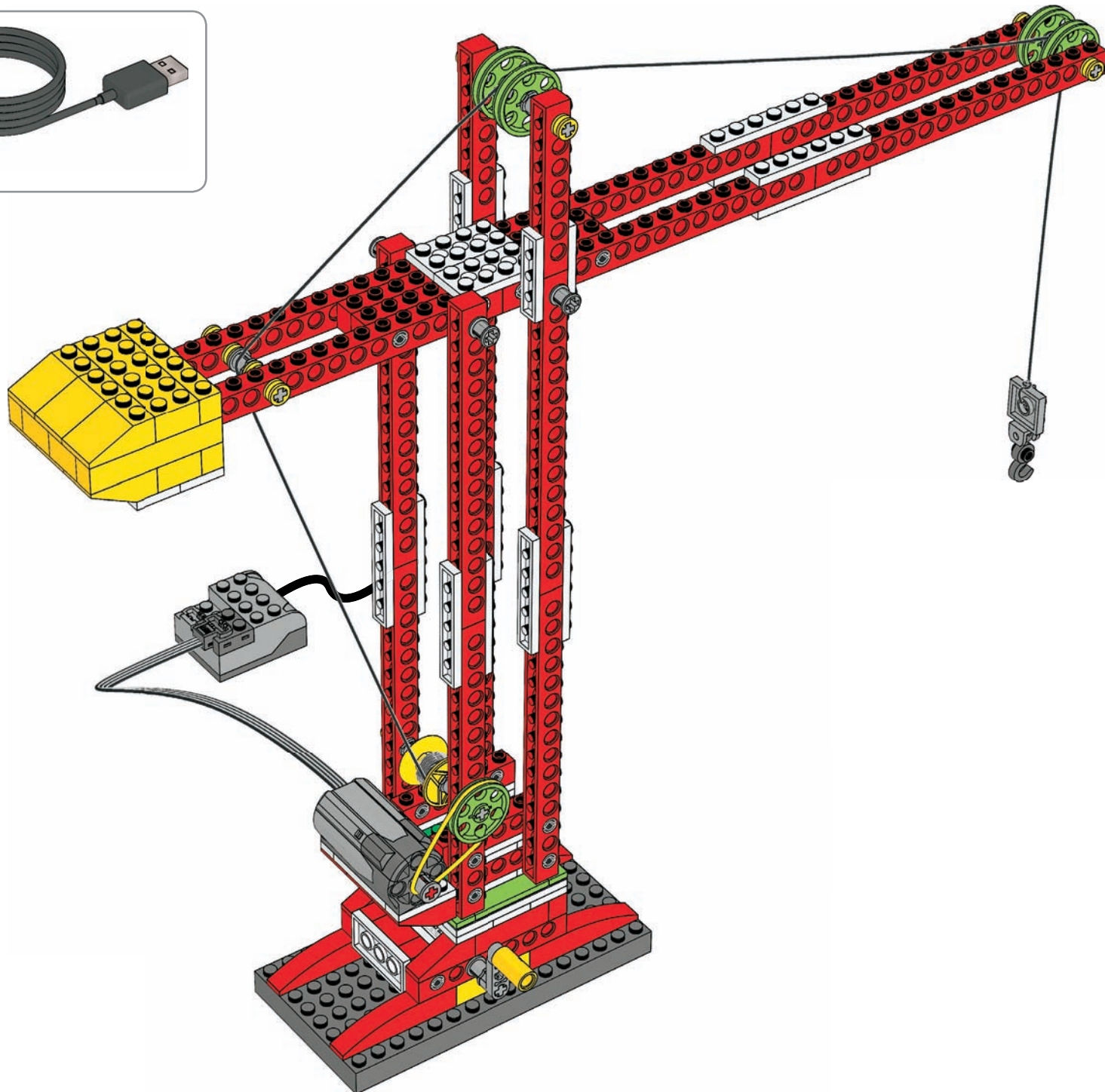



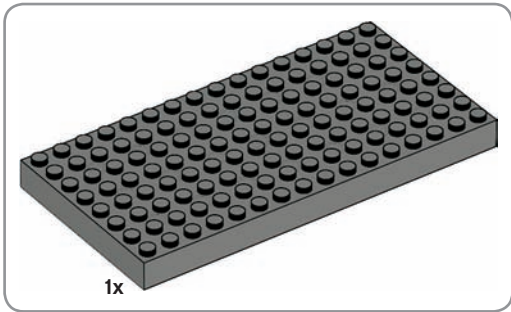
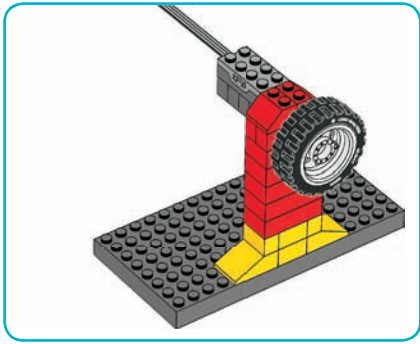

96

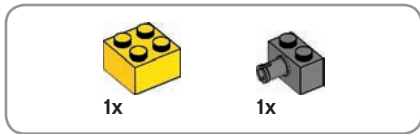
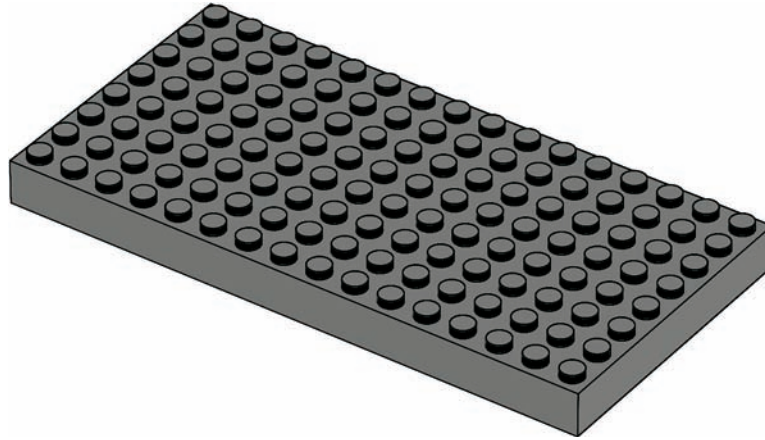

97

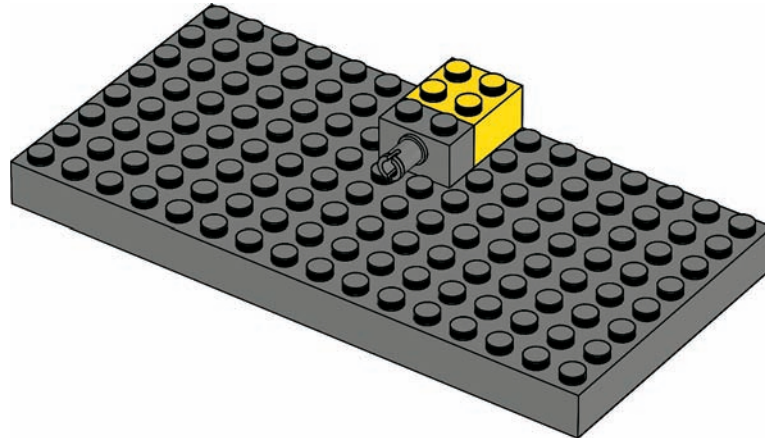

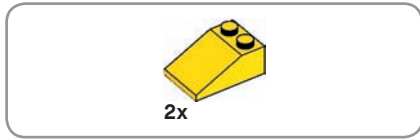

98

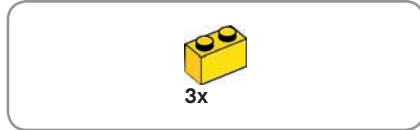
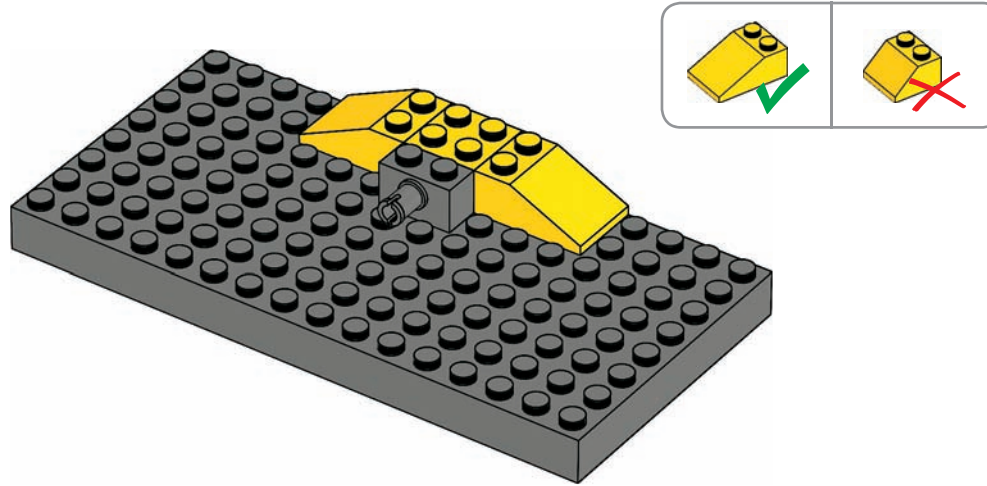

99

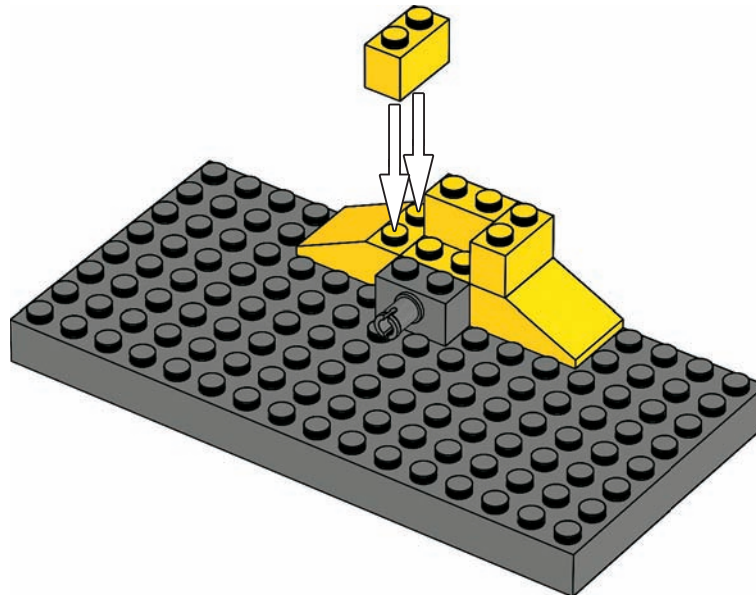



100

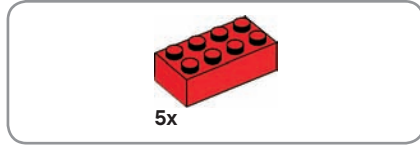
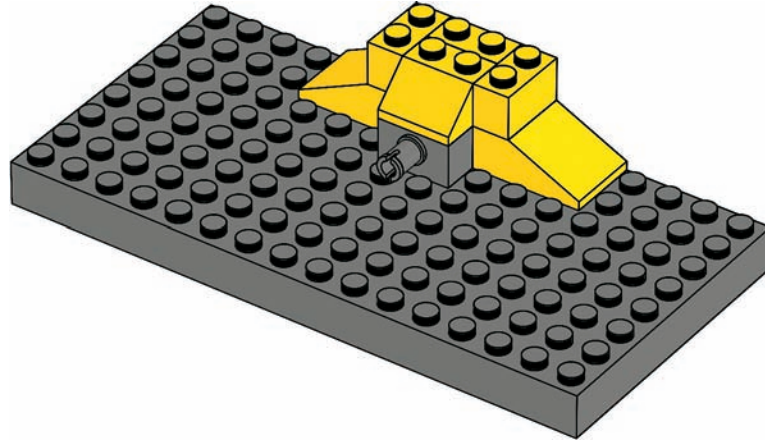

101

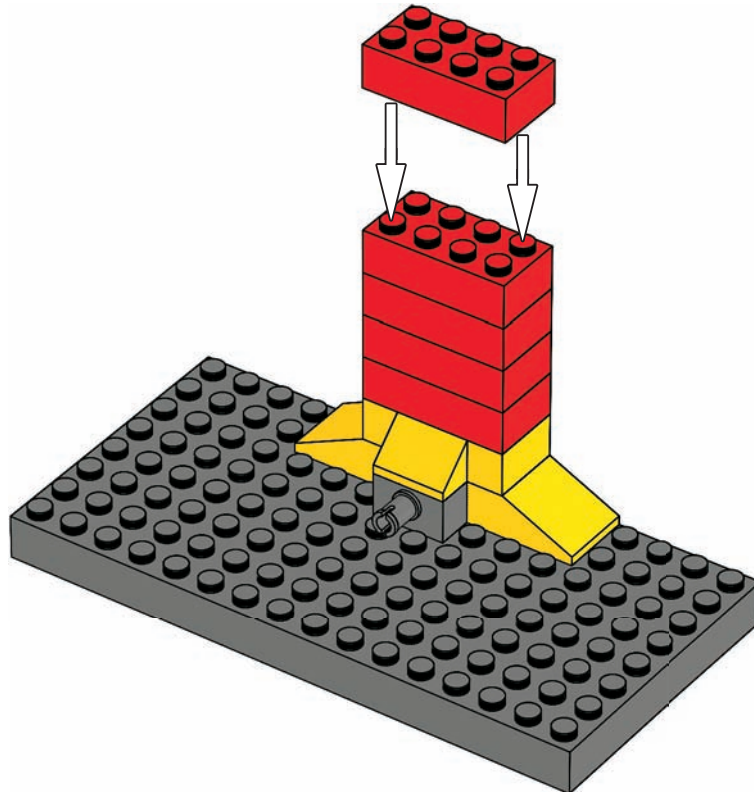



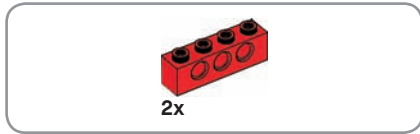

102

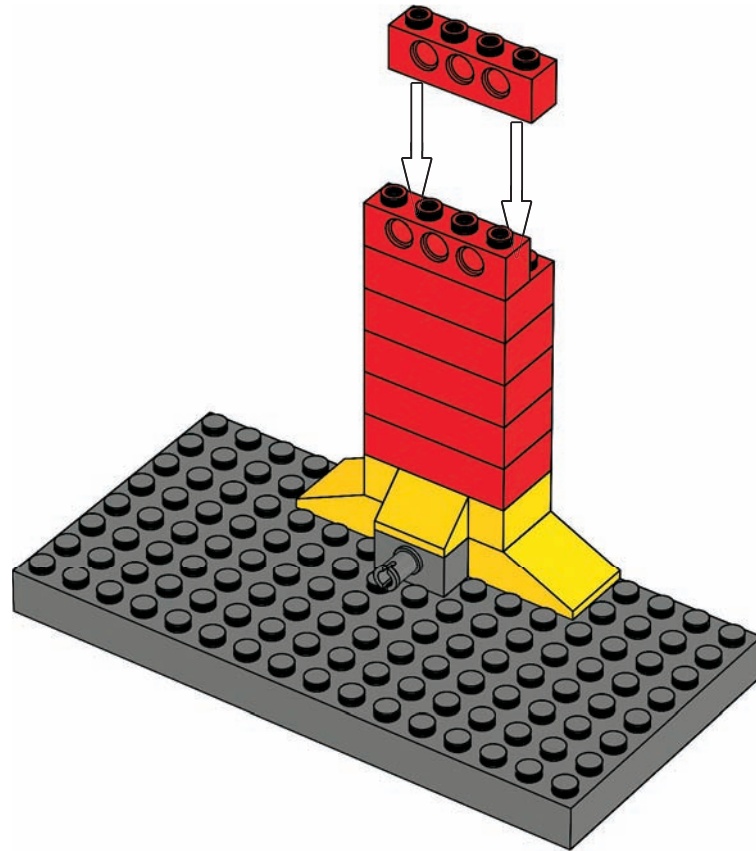

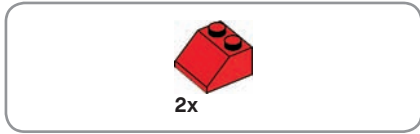

103

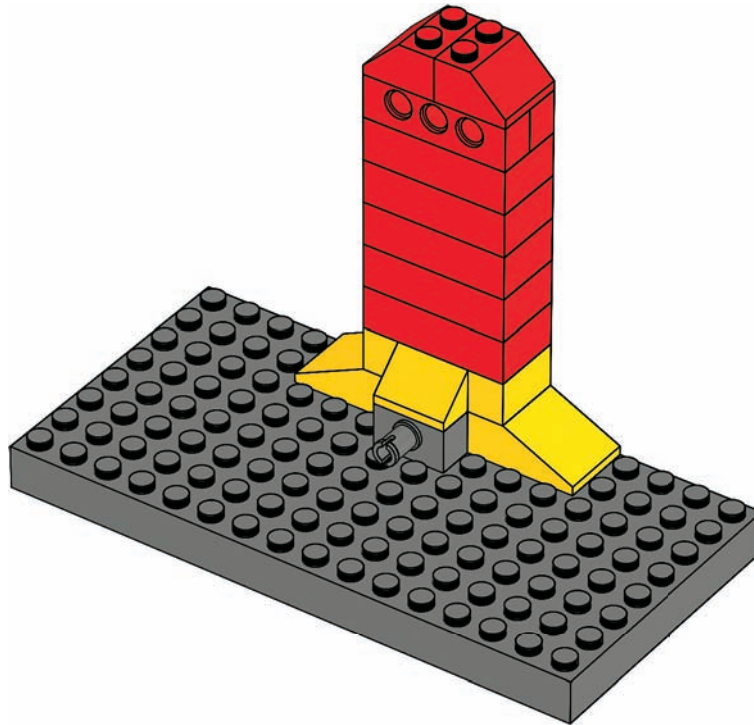



104

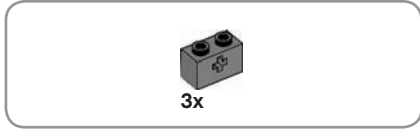

105

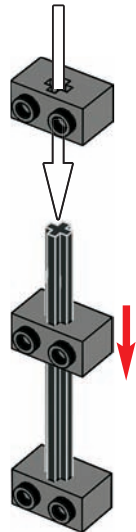



106

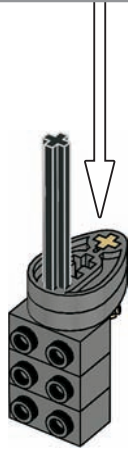
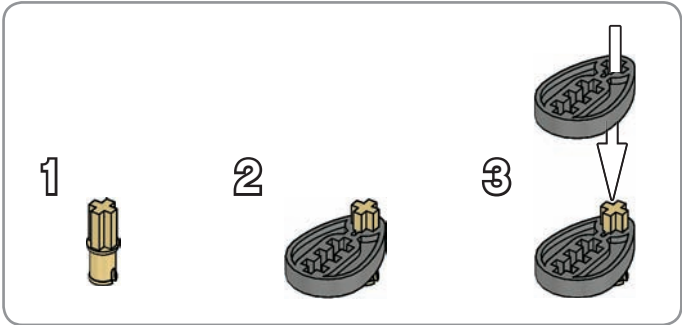



107

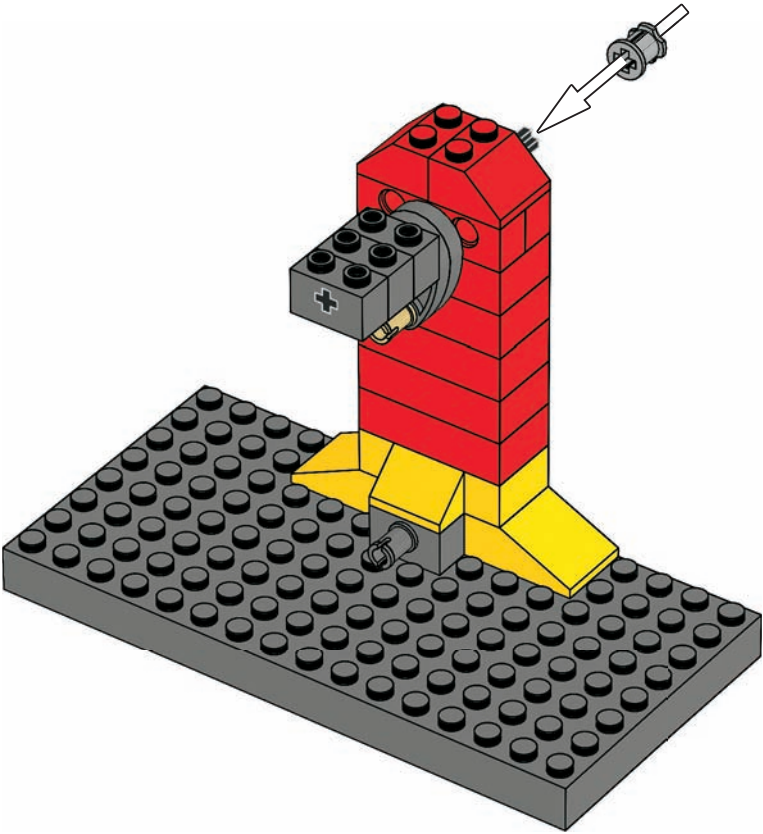

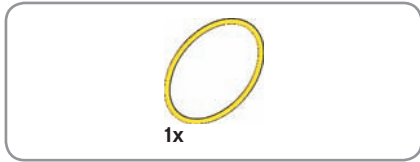

108

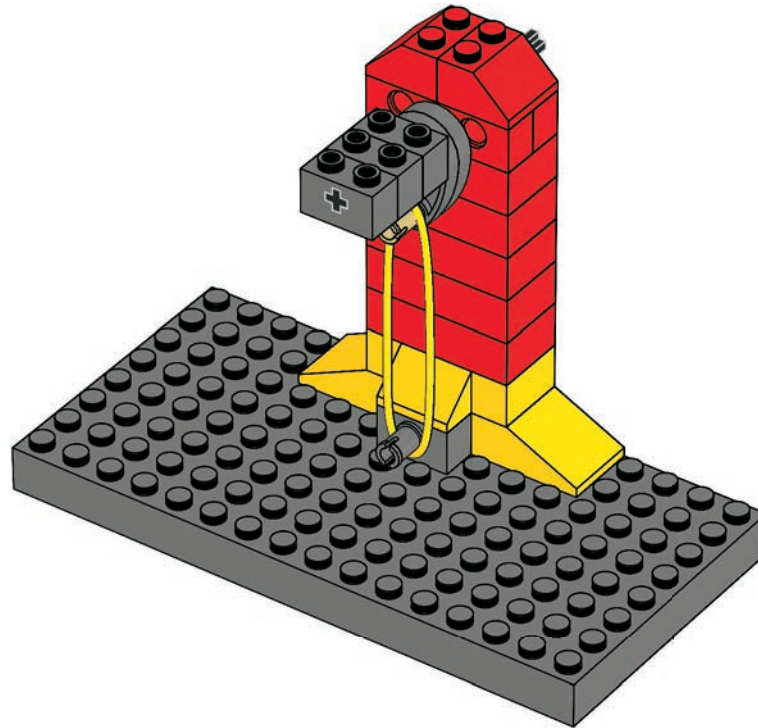



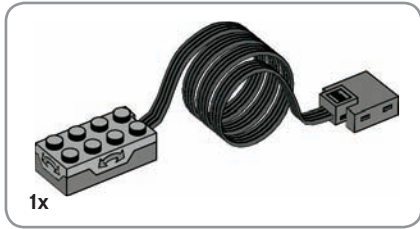

109

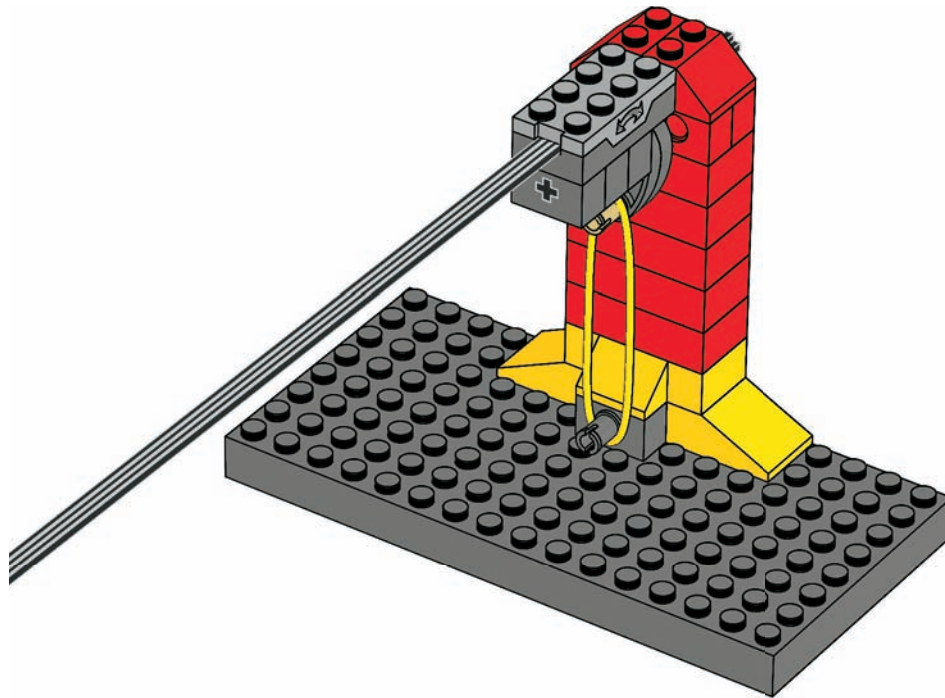

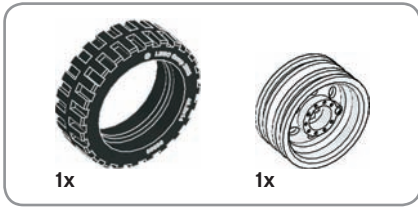

110

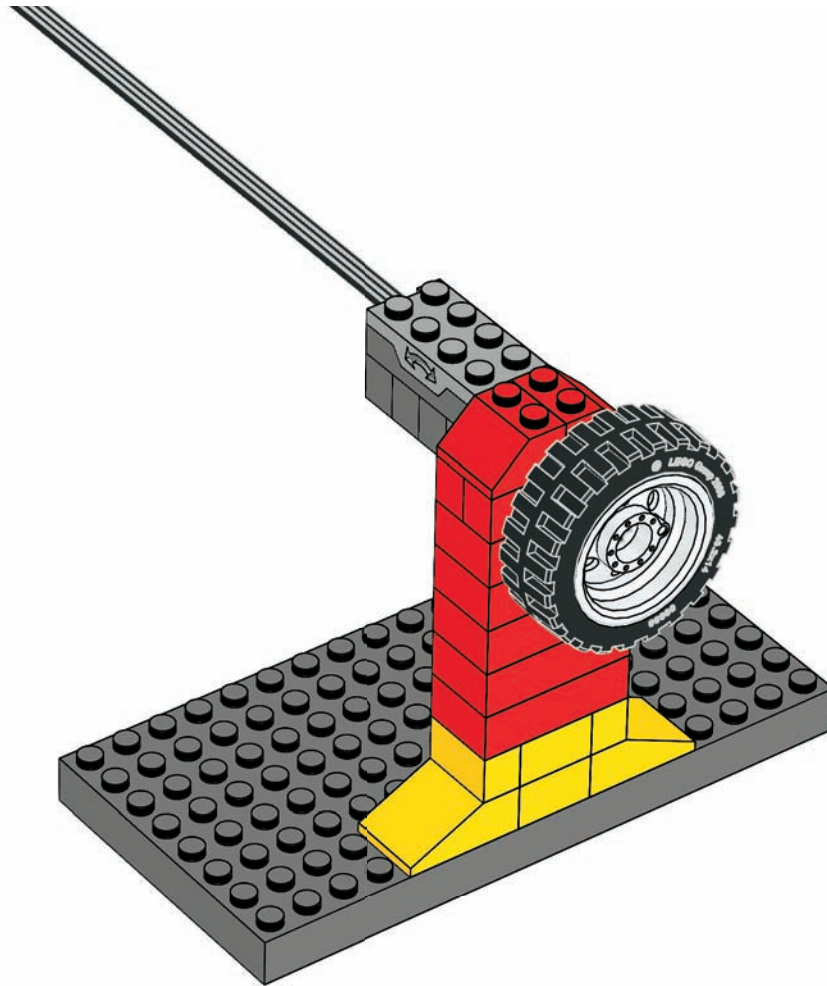

111

