

- | | | | |
|----|-----|----|-----|
| | | | |
| 1x | 5x | 2x | |
| | | | |
| 2x | 4x | 1x | |
| | | | |
| 2x | 6x | 2x | |
| | | | |
| 4x | 3x | 1x | 10x |
| | | | |
| 1x | 1x | 4x | 10x |
| | | | |
| 6x | 14x | 2x | 4x |
| | | | |
| 1x | 1x | 1x | 1x |
| | | | |
| 1x | 3x | 2x | 4x |
| | | | |
| 4x | 4x | 1x | 1x |
| | | | |
| 2x | 1x | 2x | 1x |
| | | | |
| 2x | 2x | 1x | 1x |
| | | | |
| 1x | 2x | 1x | 1x |

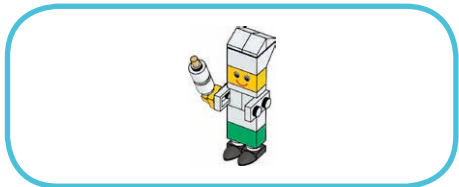

1

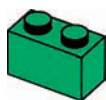

2

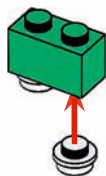

3

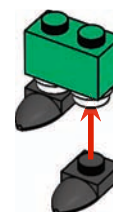

4





5



6

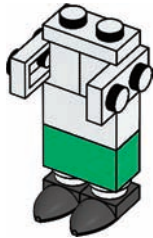

7

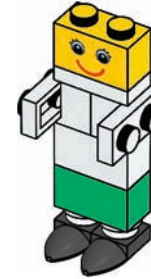

8

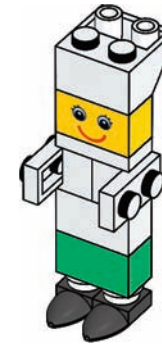



9

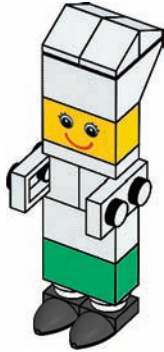

10

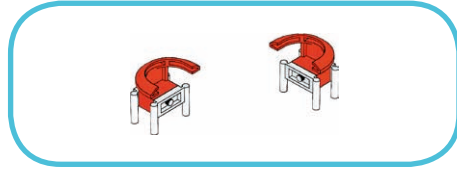
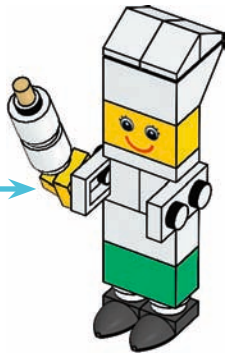
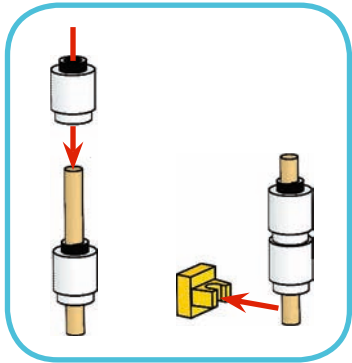

1

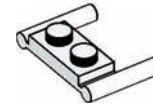

2

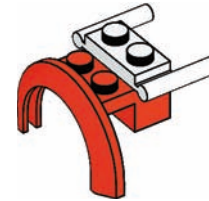

3

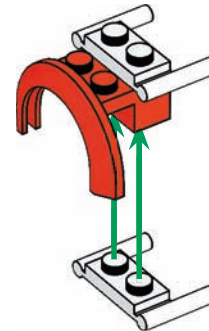

2x

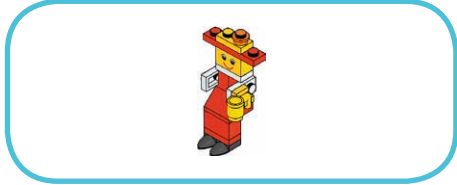

1

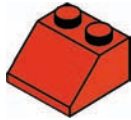

2



3

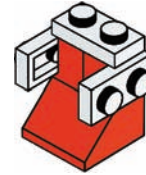

4





5

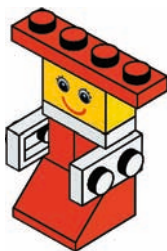

6

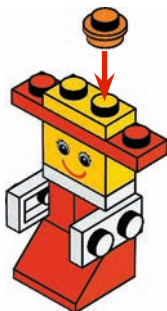

7

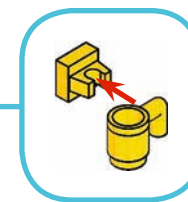

8

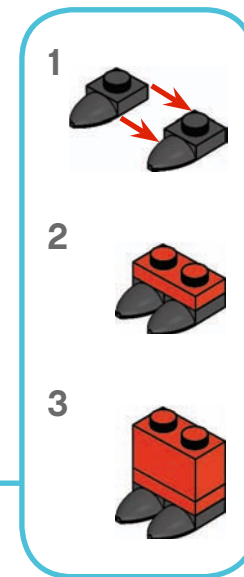

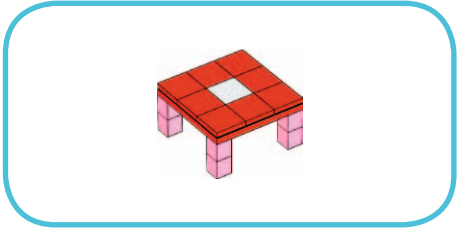

1

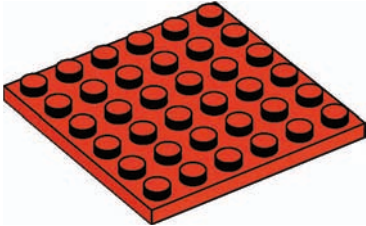

2

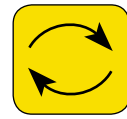
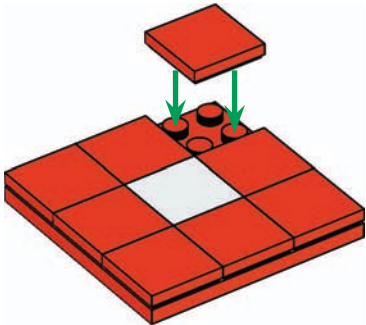

3

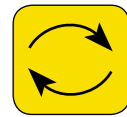
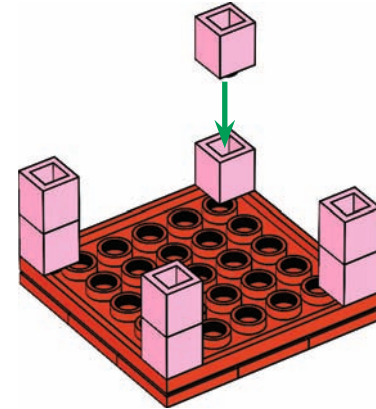

4

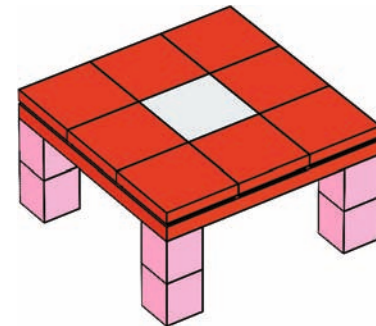

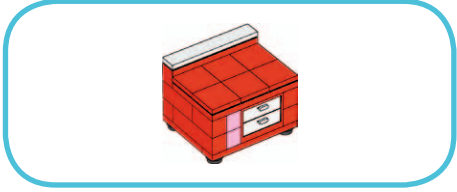

1

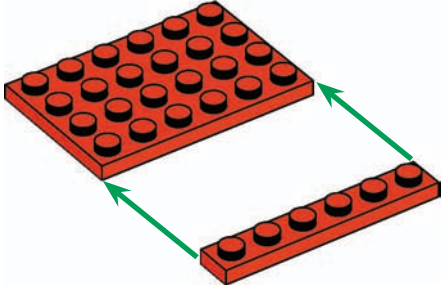

2

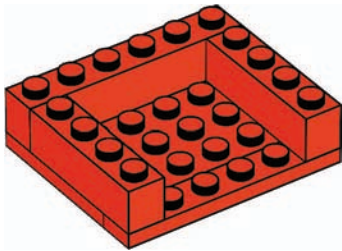

3

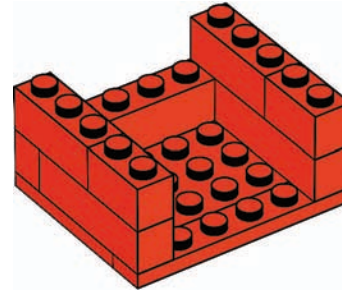

4

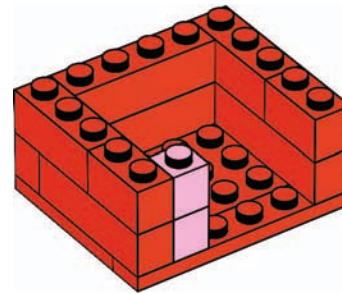



5

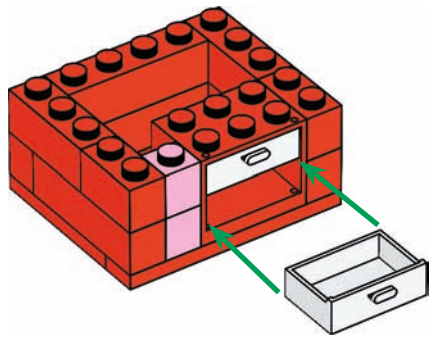

6

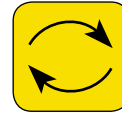
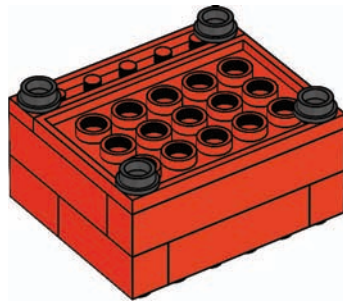

7

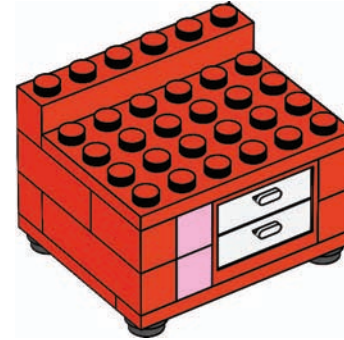

8

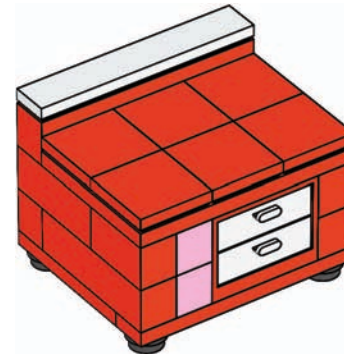

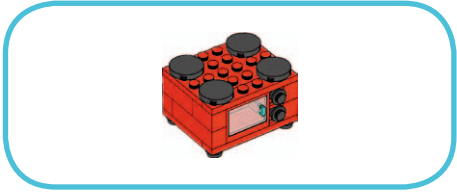

1

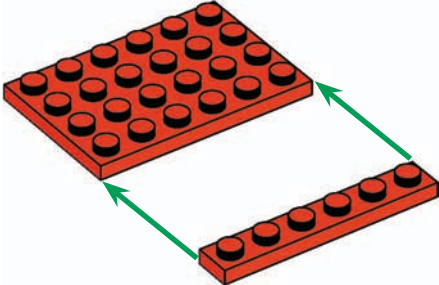

2

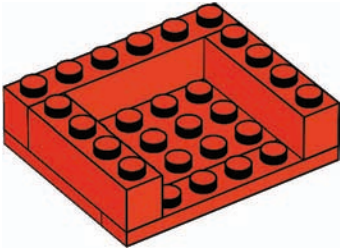

3

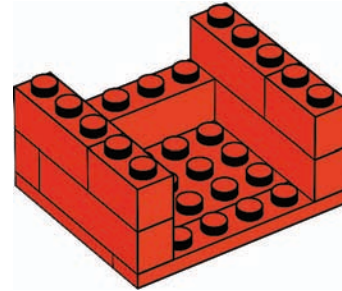

4

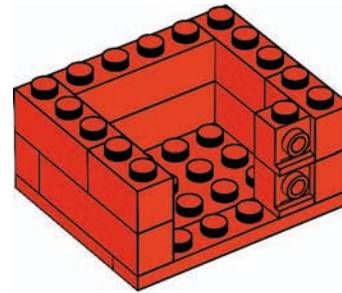



5

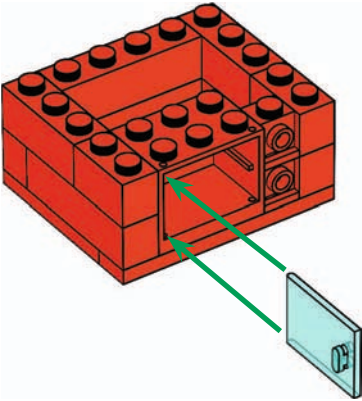

6

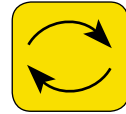
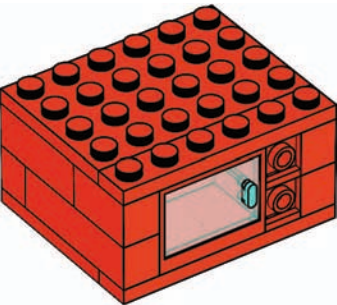

7

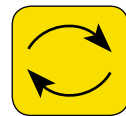
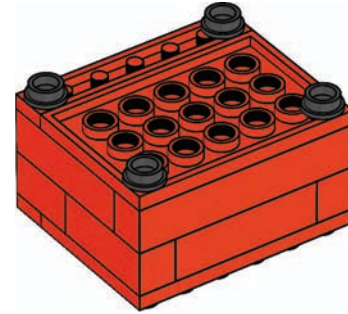

8

