

LEGO® Education WeDo 2.0 Curriculum Pack



WeDo 2.0
2045300



Table of Contents

Introduction to WeDo 2.0

3-11

WeDo 2.0 in Curriculum

12-38

Assess with WeDo 2.0

39-45

Classroom Management

46-49

Getting Started Projects

50-61

Guided Projects

62-174

Open Projects

175-207

WeDo 2.0 Toolbox

208-231

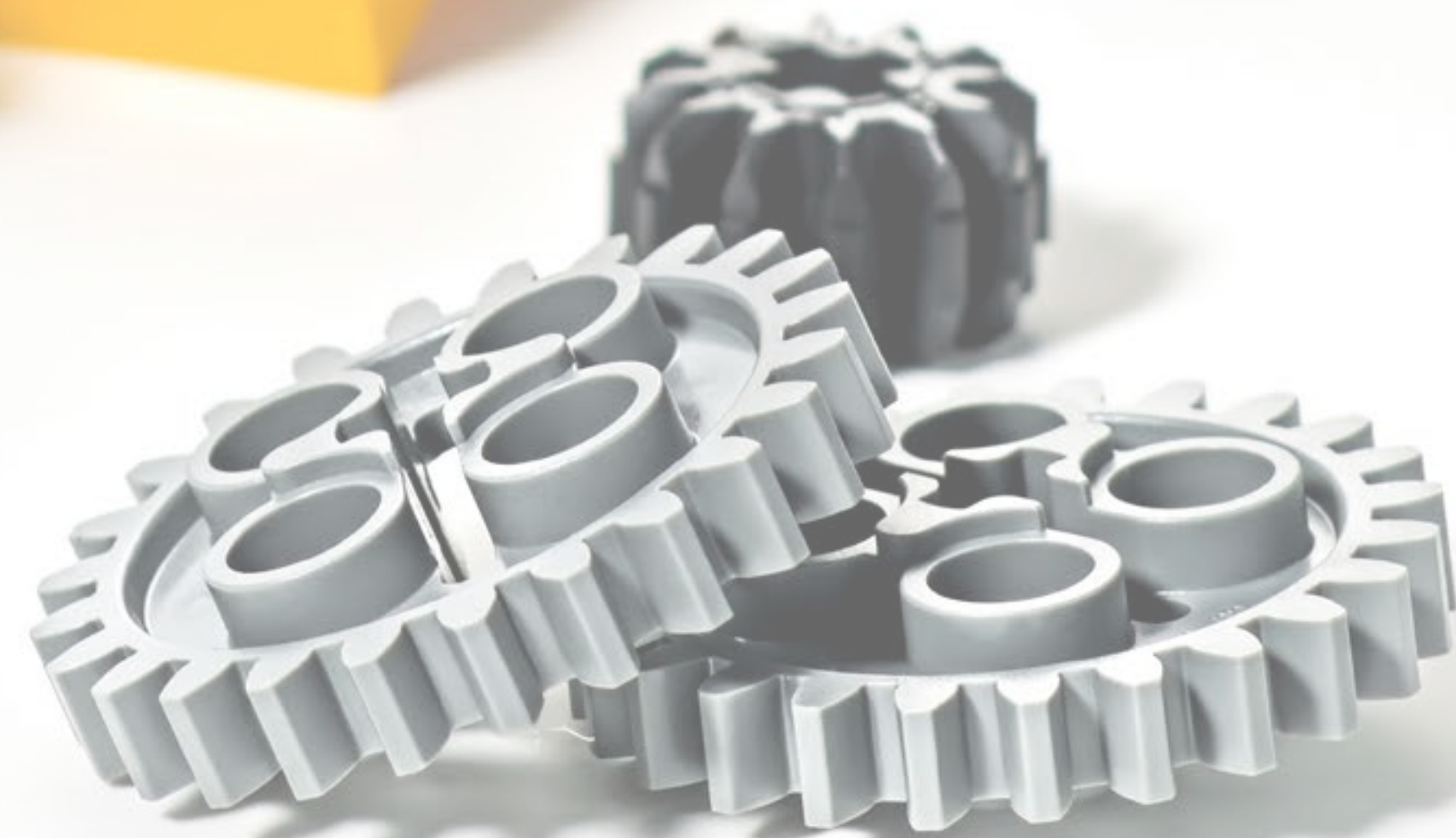

Introduction to WeDo 2.0

Welcome to the LEGO® Education WeDo 2.0 Curriculum Pack.

In this chapter, you will discover the fundamental steps required for the journey you are about to experience.





LEGO® Education WeDo 2.0 Curriculum Pack

LEGO® Education WeDo 2.0 is developed to engage and motivate primary school students' interest in learning science and engineering related subjects. This is done through the use of motorised LEGO models and simple programming.

WeDo 2.0 supports a hands-on, “minds on” learning solution that gives students the confidence to ask questions, and the tools to find answers and solve real-life problems.

Students learn by asking questions and solving problems. This material does not tell students everything they need to know. Instead it makes them question what they know and explore what they do not yet understand.





Learn science and engineering through projects

WeDo 2.0 has a range of different projects. The projects are divided into the following types:

- A Getting Started Project divided into four parts, where you can learn the basic functions of WeDo 2.0.
- Eight Guided Projects linked to the Australian Curriculum: Science requirements, with step-by-step instructions for the complete project.
- Eight Open Projects linked to the Australian Curriculum: Science requirements, with a more open experience.

The Guided Projects and the Open Projects are divided into three phases: the Explore phase, to connect students to the task; the Create phase, to allow them to build and program; and the Share phase, where they document and present their projects.

Each project should last approximately three hours. Each phase has an equal importance in the project flow and an estimated completion time of around 45 minutes, but you can modify the time spent on each phase to suit your teaching.





How to teach science with WeDo 2.0

WeDo 2.0 uses a project progression defined by three phases.

Explore phase

Students connect to a scientific question or an engineering problem, establish a line of inquiry, and consider possible solutions.

The steps of the Explore phase are: connect and discuss.

Create phase

Students build, program, and modify a LEGO® model. Projects can be one of three types: investigate, design solutions, and use models. Depending on the type of project, the Create phase will differ from one project to another.

The steps of the Create phase are: build, program, and modify.

Share phase

Students present and explain their solutions and findings using their LEGO models and the documents they have created with the integrated Documentation tool.

The steps of the Share phase are: document and present.

▶ Important

During each of these phases, students will document their findings, the answers, and the process, using various methods. This document can be exported and used for assessment, display, or sharing with parents.

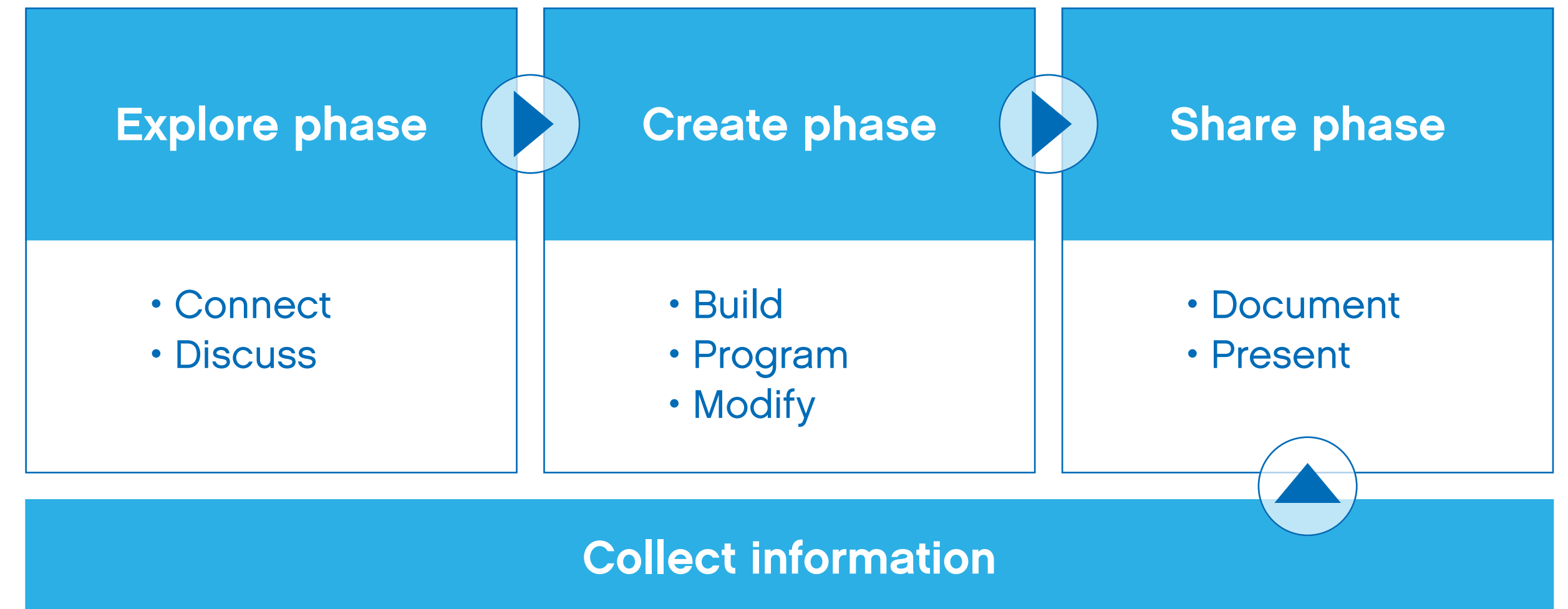



Use the Guided Projects

The Guided Projects will help you to set the scene and facilitate the learning experience. They are designed to build your students' confidence and provide the foundations necessary for success.

All Guided Projects follow the Explore, Create, and Share sequence to ensure that students progress step-by-step through the learning experience.

Teacher's notes have been provided for every project, and include:

- Curriculum links
- Detailed preparation
- Assessment grids
- Differentiation techniques and notes on possible student misconceptions
- Explore, Create, and Share Help panel

See the “Guided Projects” chapter for information about all Guided Projects.

▶ Suggestions

It is recommended that you start with the Getting Started Project followed by one or two Guided Projects to make sure students understand the approach and methodology. “Pulling” is a good Guided Project to start with.





Using Open Projects

The Open Projects also follow the Explore, Create, and Share sequence, but intentionally do not offer the same step-by-step guidance as the Guided Projects. They provide an initial brief and starting points to build on.

The key to using the Open Projects is to make them your own; offer opportunities for projects that are locally relevant and challenging in the areas you want them to be. Use your creativity to adapt these project ideas to suit your students. You will find teacher support about Open Projects in the “Open Projects” chapter.

With every Open Projects brief, students will be given three suggested base models to look at in the Design Library.

The Design Library, located in the software, will provide inspiration for students to build their own solutions. The goal is not to replicate the model, but to get help on how to build a function, such as to lift or walk. Students will find building instructions for the 15 base models in the Design Library, as well as pictures of inspirational models.

▶ Suggestion

The Design Library and Open Projects can be found in the WeDo 2.0 Software.





Document projects

Asking your students to document their work will help you to keep track, identify where they need more help, and evaluate their progress.

Students can use many different methods to express their ideas. During the ongoing documentation process, they can:

1. Take photographs of important steps of their prototypes and their final models.
2. Take photographs of their team working on important stages of the process.
3. Record a video explaining a problem they are facing.
4. Record a video explaining their investigation.
5. Make notes using the Documentation tool.
6. Find supporting pictures on the Internet.
7. Take screenshots of their programs.
8. Write, draw, or sketch on paper and then take photographs to record the information.

▶ Suggestion

A combination of paper and digital documentation can be the most effective, depending on the age group you are working with.





Share projects

At the end of the project, students will be eager to share their solutions and findings. This is a great opportunity to develop their communication abilities.

Here are a few examples of how your students can share their work:

1. Ask the students to create the display where the LEGO® model will be used.
2. Ask the students to describe their investigations or dioramas.
3. Ask a team of students to present their best solution to you, another team, or to the class.
4. Invite an expert or a group of parents to your classroom for a student presentation.
5. Organise a science fair at your school.
6. Ask the students to record videos explaining their projects, and post them online.
7. Create and display posters of the projects around your school.
8. Email the project documents to parents, or publish them in students' portfolios.

▶ Suggestion

To make this experience even more up-beat, ask each student to make a positive comment or to pose a question about another student's work during the sharing session.





The Science Lab

Max and Mia's virtual WeDo 2.0 Science Lab is a great place for students to get connected to real-life questions or problems. You can meet them in every Guided Project.

Max is always ready for a new project. He loves to discover fresh topics, and he's very creative when it's time to invent something new.

Mia is thrilled by any discoveries. She's very curious about the world around her, and she always wants to know more.

In the Getting Started Project, Max and Mia are joined by Milo the Science Rover, who is capable of great discoveries.

Max and Mia have great projects to propose, and they are excited to **welcome you to the LEGO® Education WeDo 2.0 Science Lab!**





WeDo 2.0 in the Curriculum

The LEGO® Education WeDo 2.0 solution combines LEGO bricks with the requirements of the Australian Curriculum: Science. The projects are designed to develop students' science practices.

In this chapter, you will be introduced to three innovative ways to use the bricks in your classroom:

- Model reality.
- Conduct investigations.
- Use design skills alongside the development of science practices.



Experience overview

The WeDo 2.0 projects are developed with the Australian Curriculum: Science requirements for Year 2 to Year 6 in mind.

These practices represent the requirements of the Curriculum, in that students develop scientific knowledge and conceptual understanding, as well as practical skills. The practices are not to be seen as separate, rather as an interconnected set of expectations for students.

Cross-curricular themes are also important, and teachers are encouraged to explore the connections to other subject areas.

Elements of the Australian Curriculum: Technologies are interwoven throughout the document and are used within the WeDo 2.0 curriculum.

The Australian Curriculum: Science content includes the three strands of Science Understanding, Science as a Human Endeavour, and Science Inquiry Skills.

The three strands of the science curriculum provide students with understanding, knowledge, and skills that will help them to develop a scientific view of the world.

Science inquiry describes actions that students can engage with when learning and exploring science. These skills are integral to the Australian Curriculum Science content strands and are developed throughout the WeDo 2.0 curriculum:

1. Questioning and predicting
2. Planning and conducting
3. Processing and analysing data and information
4. Evaluating
5. Communicating

The science inquiry skills can be accessed online via the ACARA webpage or by using the Australian Curriculum app.

The WeDo 2.0 curriculum projects are built around the Australian Curriculum: Science and interconnected throughout the curriculum.



Develop science and engineering practices with WeDo 2.0

WeDo 2.0 projects will develop science and engineering practices. They provide opportunities for students to work with and develop ideas and knowledge, and to gain an understanding of the world around them.

The progression and difficulty level of the projects allows students to develop competency while exploring and learning about key science topics. The projects have been carefully chosen to cover a wide variety of topics and issues.

WeDo 2.0 projects develop eight science and engineering practices:

1. Question and predict.
2. Develop and use models.
3. Plan and conduct investigations.
4. Process and analyse data and information.
5. Use computational thinking.
6. Design prototypes.
7. Evaluate.
8. Communicate.

The guiding principle is that every student should engage in all of these practices across the projects in each year group.



Science and Engineering practices

The science and engineering practices serve as the common thread throughout the curriculum, and all requirements should, in essence, be taught through them. Science inquiry involves students identifying and asking questions; planning and carrying out investigations; processing, analysing and interpreting data; and communicating findings. Engineering practices such as using models and designing prototypes are also embedded in the WeDo 2.0 projects.

The following points identify the basic principles of these practices and give examples of how they are used in WeDo 2.0 projects.

1. Questioning and predicting.

This practice focuses on identifying problems, asking questions, proposing hypotheses, and predicting possible outcomes based on observational skills.

2. Develop and use models.

This practice focuses on students' prior experiences and the use of concrete events in modelling solutions to problems. It also includes improving models and new ideas related to a real-world problem and solution.

3. Planning and conducting investigations.

This practice is about students making decisions about how to carry out an investigation, incorporate possible problem-solving processes and formulate probable solution ideas.

4. Processing and analysing data and information.

The focus of this practice is to learn how to gather, represent and interpret data, document discoveries, and share ideas from the learning process.



Science and Engineering practices

5. Use mathematics and computational thinking.

The purpose of this practice is to realise the role of numbers in data-gathering processes. Students read and gather data about investigations, make charts, and draw diagrams resulting from the numerical data. They add simple data sets to come up with conclusions. They understand or create simple algorithms.

6. Design prototypes.

This practice is about ways they might go about constructing an explanation or designing a solution for a problem.

7. Evaluate.

Constructively sharing ideas based on evidence is an important feature of science and engineering. This practice is about how students consider the quality of available evidence, share their ideas, and demonstrate proof.

8. Communicate.

Teaching children about what real scientists do is key to this practice. The way in which they set up and complete investigations to gather information, how they evaluate their findings, and how they document, are all important elements. The focus is on students presenting information and ideas to others, and communicating their findings through appropriate representations and digital technologies.

▶ Important

The WeDo 2.0 projects will engage your students in all science and engineering practices.



Use the LEGO® bricks in a scientific context

LEGO® bricks have been used in three different ways in the WeDo 2.0 projects:

1. To model reality
2. To investigate
3. To design

These three ways will give you the opportunity to develop a different set of practices, as the outcome of the project is different in each case.

1. Use models

Students represent and describe their ideas using the bricks.

Students can build a model to gather evidence or provide a simulation. Although only representations of reality, models enhance understanding and explain natural phenomena.

When implementing a modelling project, encourage students to focus their creativity on representing the reality as accurately as possible. In doing so, they will need to identify and explain the limitations of their models.

Examples of modelling Guided Projects are:

- Frog's Metamorphosis
- Plants and Pollinators

2. Investigate

Planning and carrying out investigations is an ideal framework for a science project. Students' learning is enhanced by active engagement with the problem. Students are encouraged to make predictions, carry out tests, collect data, and draw conclusions.

When implementing an investigation project, you should encourage students to pay special attention to ensure fair testing. Ask them to search for cause and effect in their tests, ensuring they change only one variable at a time.

Examples of investigating Guided Projects are:

- Pulling
- Speed
- Robust Structures



Use the LEGO® bricks in an engineering context

3. Design

Students design solutions for a problem for which there is no single answer.

The problem may require students to design a combination of plans, models, simulations, programs, and presentations. Going through the design process will require students to constantly adjust and modify their solutions to meet criteria.

While designing a solution, it will be important to recognise that the idea of “failure” in engineering is a sign of growth in the cognitive process. Therefore, students may not reach a viable solution on their first attempt or within the provided time constraints. In that case, encourage them to reflect on their process and to identify what they have learnt.

When you implement a design project, encourage students to focus their creativity on designing multiple solutions. Ask them to select the prototype they think is the best according to the criteria you have set.

Examples of designing Guided Projects are:

- Prevent Flooding
- Drop and Rescue
- Sort to Recycle

Important

Documents produced by students following the completion of these three types of projects may contain different types of information.



Use LEGO® bricks in a computational thinking context

Computational thinking is a set of problem-solving skills that are applied to working with computers and other digital devices. In WeDo 2.0, computational thinking is handled in a developmentally appropriate manner through the use of icons and programming blocks.

Computational thinking characteristics include:

- Logical reasoning
- Looking for patterns
- Organising and analysing data
- Modelling and simulations
- Using computers to assist in testing models and ideas
- Using algorithms to sequence actions

Its application in science and engineering projects enables students to use powerful digital tools to carry out investigations and build and program models, which might otherwise be tricky to do. Students use programs to activate motors, lights, sounds, or displays, or to react to sounds, tilt, or movement to implement functionalities to their models or prototypes.





Visual overview of Guided Projects

1. Pulling

Investigate the effects of balanced and unbalanced forces on the movement of an object.

2. Speed

Investigate the factors that make a car accelerate to help predict future motion.

3. Robust Structures

Investigate the characteristics that make a building earthquake resistant, using an earthquake simulator constructed from LEGO® bricks.

4. Frog's Metamorphosis

Model a frog's metamorphosis using a LEGO representation, and identify the characteristics of the organism at each stage.

5. Plants and Pollinators

Model a LEGO representation of the relationship between a pollinator and flower during the reproduction phase.

6. Prevent Flooding

Design an automatic LEGO floodgate to control water according to various precipitation patterns.

7. Drop and Rescue

Design a device to reduce the impacts on humans, animals, and the environment after an area has been damaged by extreme weather.

8. Sort to Recycle

Design a device that uses the physical properties of objects, including their shape and size, to sort them.

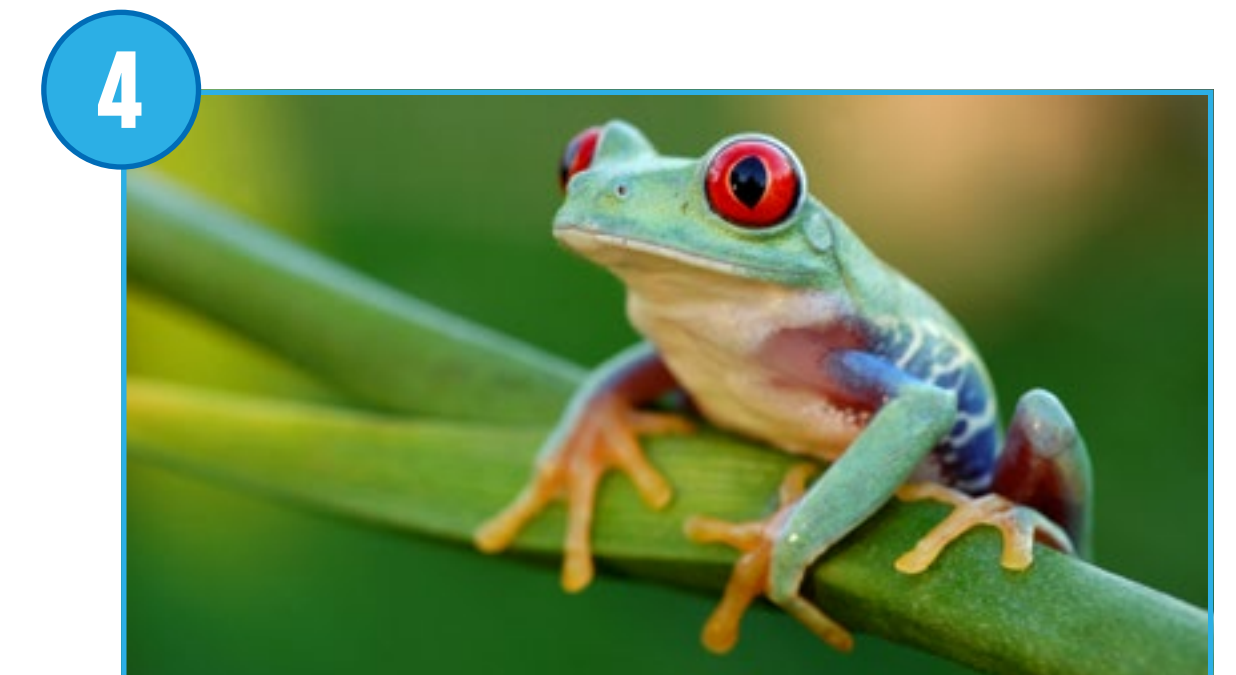
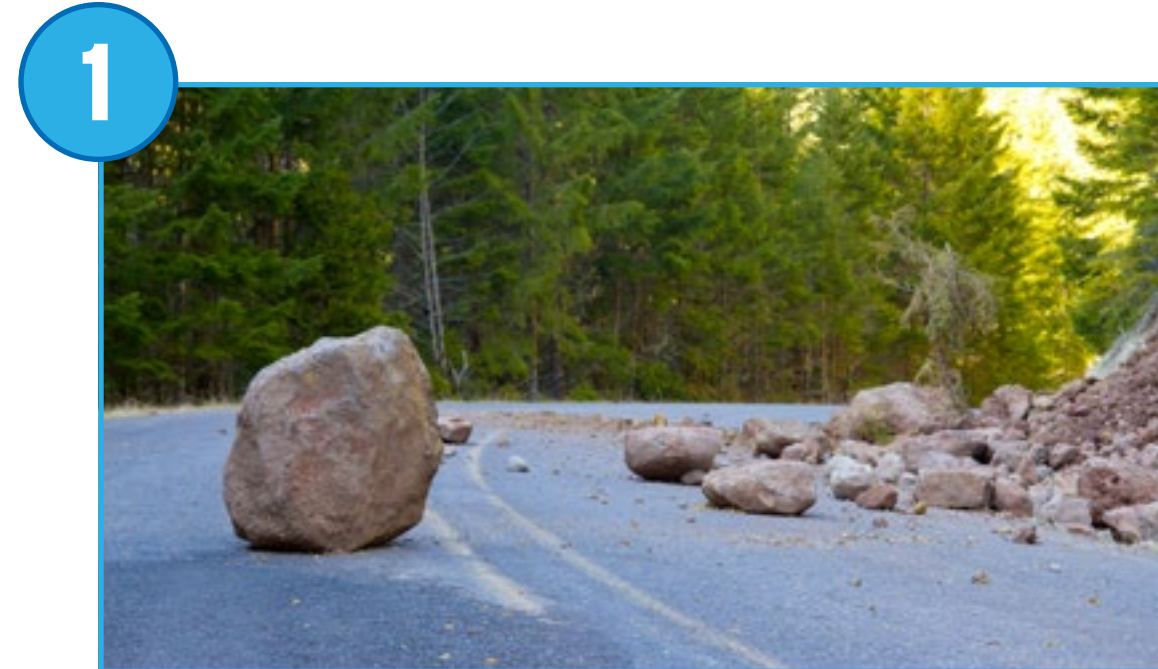



Visual overview of Open Projects

9. Predator and Prey

Model a LEGO® representation of the behaviours of different predators and their prey.

10. Animal Expression

Model a LEGO representation of different communication methods used in the animal kingdom.

11. Extreme Habitats

Model a LEGO representation of how habitat influences the survival of certain species.

12. Space Exploration

Design a LEGO prototype of a rover that would be ideal for exploring distant planets.

13. Hazard Alarm

Design a LEGO prototype of a weather alarm device to reduce the impact of severe storms.

14. Cleaning the Ocean

Design a LEGO prototype to help people remove plastic waste from the ocean.

15. Wildlife Crossing

Design a LEGO prototype to allow an endangered species to safely cross a road or other hazardous area.

16. Moving Materials

Design a LEGO prototype of a device that can move specific objects in a safe and efficient way.

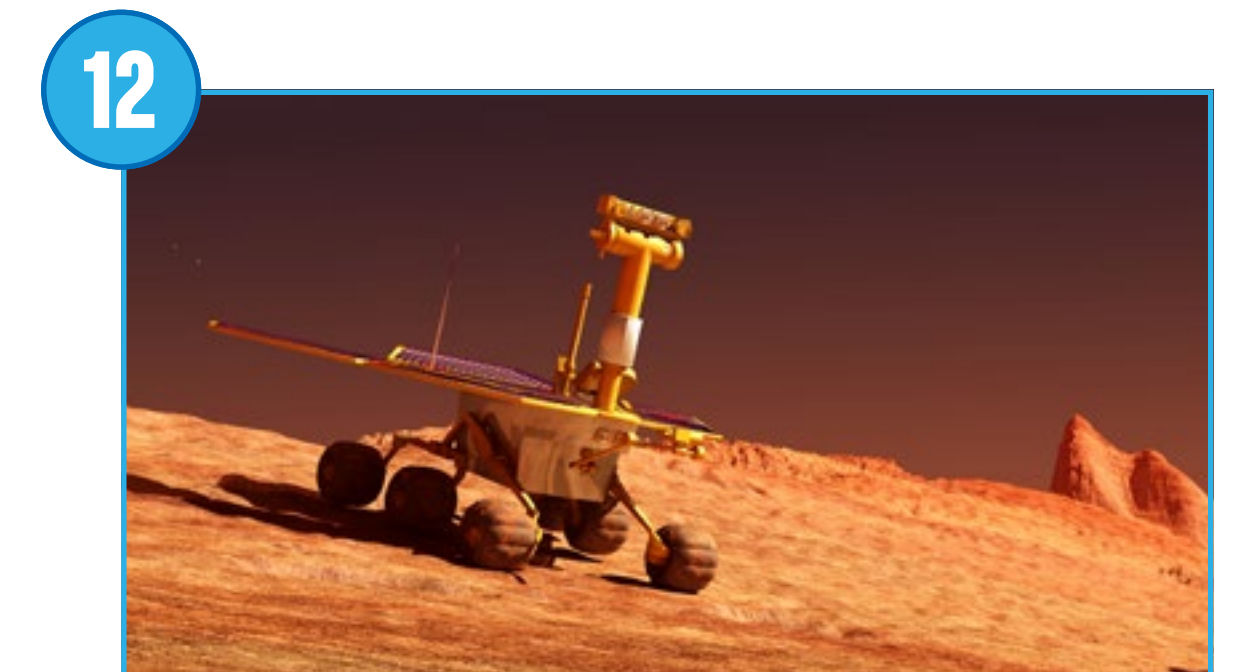
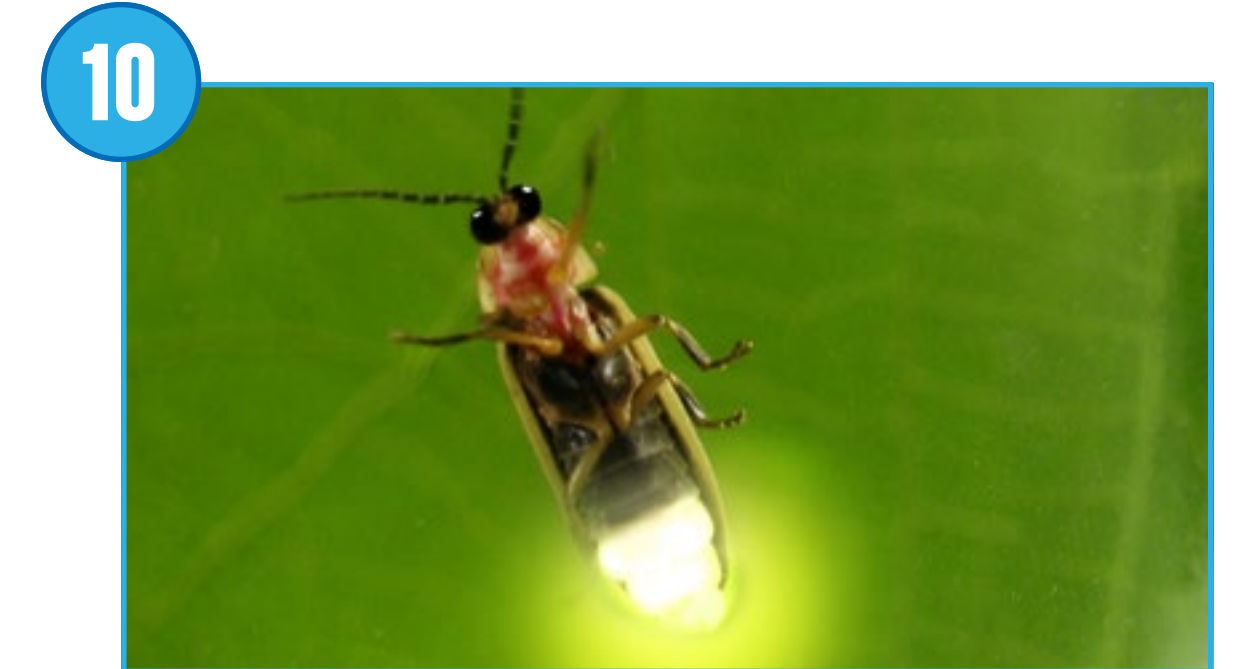



Curriculum Overview Science: Guided Projects

Guided Projects											
Project	Science Inquiry Skills					Science Understanding				Science as a Human Endeavour	
	■ Year 2 ■ Year 3 ■ Year 4 ■ Year 5 ■ Year 6										
	Questioning and predicting	Planning and conducting	Processing and analysing data and information	Evaluating	Communicating	Biological sciences	Chemical sciences	Earth and space sciences	Physical sciences	Nature and development of science	Use and influence of science
Pulling	■ ACSIS037 ■ ACSIS064	■ ACSIS038 ■ ACSIS065	■ ACSIS216	■ ACSIS041 ■ ACSIS069	■ ACSIS042 ■ ACSIS071				■ ACSSU033 ■ ACSSU076	■ ACSHE034 ■ ACSHE061	
Speed	■ ACSIS064	■ ACSIS065	■ ACSIS216	■ ACSIS069	■ ACSIS071				■ ACSSU076	■ ACSHE061	
Robust Structures	■ ACSIS232	■ ACSIS103	■ ACSIS221	■ ACSIS108	■ ACSIS110			■ ACSSU096		■ ACSHE098	■ ACSHE100
Frog's Metamorphosis	■ ACSIS053		■ ACSIS215 ■ ACSIS216	■ ACSIS041 ■ ACSIS058 ■ ACSIS069	■ ACSIS042 ■ ACSIS060 ■ ACSIS071	■ ACSSU030 ■ ACSSU044 ■ ACSSU072				■ ACSHE034 ■ ACSHE050 ■ ACSHE061	
Plants and Pollinators	■ ACSIS064				■ ACSIS071	■ ACSSU073				■ ACSHE061	
Prevent Flooding	■ ACSIS064 ■ ACSIS232	■ ACSIS103			■ ACSIS071 ■ ACSIS110			■ ACSSU075 ■ ACSSU096		■ ACSHE061 ■ ACSHE098	■ ACSHE062
Drop and Rescue		■ ACSIS103			■ ACSIS110			■ ACSSU096			■ ACSHE100
Sort to Recycle	■ ACSIS037 ■ ACSIS216	■ ACSIS038		■ ACSIS069	■ ACSIS042 ■ ACSIS071		■ ACSSU031 ■ ACSSU074			■ ACSHE034	■ ACSHE035 ■ ACSHE062

NB: Australian Curriculum: Technologies requirements are referenced in the teacher's notes for each project.



Curriculum Overview Science: Open Projects

Open Projects											
Project	Science Inquiry Skills					Science Understanding				Science as a Human Endeavour	
	■ Year 2 ■ Year 3 ■ Year 4 ■ Year 5 ■ Year 6										
	Questioning and predicting	Planning and conducting	Processing and analysing data and information	Evaluating	Communicating	Biological sciences	Chemical sciences	Earth and space sciences	Physical sciences	Nature and development of science	Use and influence of science
Predator and Prey		■ ACSIS065	■ ACSIS216	■ ACSIS069	■ ACSIS071	■ ACSSU073				■ ACSHE061	
Animal Expression	■ ACSIS053		■ ACSIS215	■ ACSIS058	■ ACSIS060	■ ACSSU044				■ ACSHE050	
Extreme Habitats				■ ACSIS091	■ ACSIS093	■ ACSSU043					
Space Exploration	■ ACSIS231	■ ACSIS086		■ ACSIS091	■ ACSIS093			■ ACSSU078		■ ACSHE081	■ ACSHE083
Hazard Alarm		■ ACSIS103	■ ACSIS221	■ ACSIS108	■ ACSIS110			■ ACSSU096		■ ACSHE098	■ ACSHE100
Cleaning the Ocean		■ ACSIS065		■ ACSIS069	■ ACSIS071		■ ACSSU074				■ ACSHE062
Wildlife Crossing		■ ACSIS065	■ ACSIS216	■ ACSIS069	■ ACSIS071	■ ACSSU073					■ ACSHE062
Moving Materials		■ ACSIS065		■ ACSIS069	■ ACSIS071				■ ACSSU076		■ ACSHE062

NB: Australian Curriculum: Technologies requirements are referenced in the teacher's notes for each project.



Curriculum Overview: Science – Year 2

Science Understanding	
Biological sciences	
ACSSU030	Living things grow, change, and have offspring similar to themselves
Chemical sciences	
ACSSU031	Different materials can be combined, including by mixing, for a particular purpose
Earth and space sciences	
ACSSU032	Earth's resources, including water, are used in a variety of ways
Physical sciences	
ACSSU033	A push or a pull affects how an object moves or changes shape
Science as a Human Endeavour	
Nature and development of science	
ACSHE034	Science involves asking questions about, and describing changes in, objects and events
Use and influence of science	
ACSHE035	People use science in their daily lives, including when caring for their environment and living things
Science Inquiry Skills	
Questioning and predicting	
AC SIS037	Pose and respond to questions, and make predictions about familiar objects and events
Planning and conducting	
AC SIS038	Participate in guided investigations to explore and answer questions
AC SIS039	Use informal measurements in the collection and recording of observations, with the assistance of digital technologies as appropriate
Processing and analysing data and information	
AC SIS040	Use a range of methods to sort information, including drawings and provided tables and through discussion, compare observations with predictions
Evaluating	
AC SIS041	Compare observations with those of others
Communicating	
AC SIS042	Represent and communicate observations and ideas in a variety of ways

<http://www.australiancurriculum.edu.au/science>

NB: Australian Curriculum: Technologies requirements are referenced in the teacher's notes for each project.



Curriculum Overview: Science – Year 3

Science Understanding	
Biological sciences	
ACSSU044	Living things can be grouped on the basis of observable features and can be distinguished from non-living things
Chemical sciences	
ACSSU046	A change of state between solid and liquid can be caused by adding or removing heat
Earth and space sciences	
ACSSU048	Earth's rotation on its axis causes regular changes, including night and day
Physical sciences	
ACSSU049	Heat can be produced in many ways and can move from one object to another
Science as a Human Endeavour	
Nature and development of science	
ACSHE050	Science involves making predictions and describing patterns and relationships
Use and influence of science	
ACSHE051	Science knowledge helps people to understand the effect of their actions
Science Inquiry Skills	
Questioning and predicting	
AC SIS053	With guidance, identify questions in familiar contexts that can be investigated scientifically and make predictions based on prior knowledge
Planning and conducting	
AC SIS054	With guidance, plan and conduct scientific investigations to find answers to questions, considering the safe use of appropriate materials and equipment
AC SIS055	Consider the elements of fair tests and use formal measurements and digital technologies as appropriate, to make and record observations accurately
Processing and analysing data and information	
AC SIS057	Use a range of methods including tables and simple column graphs to represent data and to identify patterns and trends
AC SIS215	Compare results with predictions, suggesting possible reasons for findings
Evaluating	
AC SIS058	Reflect on the investigation, including whether a test was fair or not
Communicating	
AC SIS060	Represent and communicate observations, ideas and findings using formal and informal representations

<http://www.australiancurriculum.edu.au/science>



Curriculum Overview: Science – Year 4

Science Understanding	
Biological sciences	
ACSSU072	Living things have life cycles
ACSSU073	Living things depend on each other and the environment to survive
ACSSU074	Natural and processed materials have a range of physical properties; These properties can influence their use
Earth and space sciences	
ACSSU075	Earth's surface changes over time as a result of natural processes and human activity
Physical sciences	
ACSSU076	Forces can be exerted by one object on another through direct contact or from a distance
Science as a Human Endeavour	
Nature and development of science	
ACSHE061	Science involves making predictions and describing patterns and relationships
Use and influence of science	
ACSHE062	Science knowledge helps people to understand the effect of their actions
Science Inquiry Skills	
Questioning and predicting	
AC SIS064	With guidance, identify questions in familiar contexts that can be investigated scientifically and make predictions based on prior knowledge
Planning and conducting	
AC SIS065	With guidance, plan and conduct scientific investigations to find answers to questions, considering the safe use of appropriate materials and equipment
AC SIS066	Consider the elements of fair tests and use formal measurements and digital technologies as appropriate, to make and record observations accurately
Processing and analysing data and information	
AC SIS068	Use a range of methods including tables and simple column graphs to represent data and to identify patterns and trends
AC SIS216	Compare results with predictions, suggesting possible reasons for findings
Evaluating	
AC SIS069	Reflect on the investigation; including whether a test was fair or not
Communicating	
AC SIS071	Represent and communicate observations, ideas, and findings using formal and informal representations

<http://www.australiancurriculum.edu.au/science>



Curriculum Overview: Science – Year 5

Science Understanding	
Biological sciences	
ACSSU043	Living things have structural features and adaptations that help them to survive in their environment
Chemical sciences	
ACSSU077	Solids, liquids, and gases have different observable properties and behave in different ways
Earth and space sciences	
ACSSU078	The Earth is part of a system of planets orbiting around a star (the sun)
Physical sciences	
ACSSU080	Light from a source forms shadows and can be absorbed, reflected, and refracted
Science as a Human Endeavour	
Nature and development of science	
ACSHE081	Science involves testing predictions by gathering data and using evidence to develop explanations of events and phenomena, and reflects historical and cultural contributions
Use and influence of science	
ACSHE083	Scientific knowledge is used to solve problems and inform personal and community decisions
Science Inquiry Skills	
Questioning and predicting	
AC SIS231	With guidance, pose clarifying questions and make predictions about scientific investigations
Planning and conducting	
AC SIS086	Identify, plan, and apply the elements of scientific investigations to answer questions and solve problems using equipment and materials safely while identifying potential risks
AC SIS087	Decide which variable should be changed and measured in fair tests and accurately observe, measure, and record data, using digital technologies as appropriate
Processing and analysing data and information	
AC SIS090	Construct and use a range of representations, including tables and graphs, to represent and describe observations, patterns, or relationships in data using digital technologies as appropriate
AC SIS218	Compare data with predictions and use as evidence in developing explanations
Evaluating	
AC SIS091	Reflect on and suggest improvements to scientific investigations
Communicating	
AC SIS093	Communicate ideas, explanations, and processes using scientific representations in a variety of ways, including multi-modal texts

<http://www.australiancurriculum.edu.au/science>



Curriculum Overview: Science – Year 6

Science Understanding	
Biological sciences	
ACSSU094	The growth and survival of living things is affected by the physical conditions of their environment
Chemical sciences	
ACSSU095	Changes to materials can be reversible or irreversible
Earth and space sciences	
ACSSU096	Sudden geological changes or extreme weather conditions can affect Earth's surface
Physical sciences	
ACSSU097	Electrical energy can be transferred and transformed in electrical circuits and can be generated from a range of sources
Science as a Human Endeavour	
Nature and development of science	
ACSHE098	Science involves testing predictions by gathering data and using evidence to develop explanations of events and phenomena, and reflects historical and cultural contributions
Use and influence of science	
ACSHE100	Scientific knowledge is used to solve problems and inform personal and community decisions
Science Inquiry Skills	
Questioning and predicting	
AC SIS232	With guidance, pose clarifying questions and make predictions about scientific investigations
Planning and conducting	
AC SIS103	Identify, plan, and apply the elements of scientific investigations to answer questions and solve problems using equipment and materials safely while identifying potential risks
AC SIS104	Decide which variable should be changed and measured in fair tests and accurately observe, measure, and record data using digital technologies as appropriate
AC SIS105	Use equipment and materials safely, identifying potential risks
Processing and analysing data and information	
AC SIS107	Construct and use a range of representations, including tables and graphs, to represent and describe observations, patterns, or relationships in data using digital technologies as appropriate
AC SIS221	Compare data with predictions and use as evidence in developing explanations
Evaluating	
AC SIS108	Reflect on and suggest improvements to scientific investigations
Communicating	
AC SIS110	Communicate ideas, explanations, and processes using scientific representations in a variety of ways, including multi-modal texts

<http://www.australiancurriculum.edu.au/science>



Curriculum Overview Design and Technologies: Guided Projects

■ Year F-2 ■ Year 3-4 ■ Year 5-6						
Project	Process and Production Skills				Knowledge and Understanding	
	<i>Investigating and defining</i>	<i>Producing and implementing</i>	<i>Evaluating</i>	<i>Collaborating and managing</i>	<i>Technologies contexts</i>	<i>Technologies and Society</i>
					Engineering principles and systems	Materials and technologies specialisation
Pulling	■ ACTDEP024	■ ACTDEP007 ■ ACTDEP016			■ ACTDEK002 ■ ACTDEK011 ■ ACTDEK020	
Speed	■ ACTDEP024	■ ACTDEP007 ■ ACTDEP016			■ ACTDEK002 ■ ACTDEK011 ■ ACTDEK020	
Robust Structures		■ ACTDEP016	■ ACTDEP017		■ ACTDEK011	■ ACTDEK010
Frog's Metamorphosis		■ ACTDEP007			■ ACTDEK002	
Plants and Pollinators	■ ACTDEP024	■ ACTDEP007			■ ACTDEK002 ■ ACTDEK020	
Prevent Flooding	■ ACTDEP024	■ ACTDEP016	■ ACTDEP017		■ ACTDEK011 ■ ACTDEK020	■ ACTDEK023 ■ ACTDEK019
Drop and Rescue	■ ACTDEP024	■ ACTDEP016	■ ACTDEP017		■ ACTDEK011	■ ACTDEK019
Sort to Recycle	■ ACTDEP014 ■ ACTDEP024	■ ACTDEP016	■ ACTDEP008 ■ ACTDEP017	■ ACTDEP009		■ ACTDEK004 ■ ACTDEK013 ■ ACTDEK023 ■ ACTDEK001 ■ ACTDEK010 ■ ACTDEK019



Curriculum Overview Digital Technologies: Guided Projects

■ Year F-2 ■ Year 3-4 ■ Year 5-6				
Project	Process and Production Skills			Knowledge and Understanding
	<i>Investigating and defining</i>	<i>Generating and designing</i>	<i>Producing and implementing</i>	<i>Digital Systems</i>
Pulling	<ul style="list-style-type: none"> ■ ACTDIP004 ■ ACTDIP010 	<ul style="list-style-type: none"> ■ ACTDIP019 	<ul style="list-style-type: none"> ■ ACTDIP011 ■ ACTDIP020 	<ul style="list-style-type: none"> ■ ACTDIK001 ■ ACTDIK007 ■ ACTDIK014
Speed	<ul style="list-style-type: none"> ■ ACTDIP004 ■ ACTDIP010 	<ul style="list-style-type: none"> ■ ACTDIP019 	<ul style="list-style-type: none"> ■ ACTDIP011 ■ ACTDIP020 	<ul style="list-style-type: none"> ■ ACTDIK001 ■ ACTDIK007 ■ ACTDIK014
Robust Structures	<ul style="list-style-type: none"> ■ ACTDIP004 	<ul style="list-style-type: none"> ■ ACTDIP019 	<ul style="list-style-type: none"> ■ ACTDIP011 ■ ACTDIP020 	<ul style="list-style-type: none"> ■ ACTDIK001 ■ ACTDIK007 ■ ACTDIK014
Frog's Metamorphosis	<ul style="list-style-type: none"> ■ ACTDIP004 ■ ACTDIP010 	<ul style="list-style-type: none"> ■ ACTDIP019 	<ul style="list-style-type: none"> ■ ACTDIP011 ■ ACTDIP020 	<ul style="list-style-type: none"> ■ ACTDIK001 ■ ACTDIK007 ■ ACTDIK014
Plants and Pollinators	<ul style="list-style-type: none"> ■ ACTDIP004 ■ ACTDIP010 	<ul style="list-style-type: none"> ■ ACTDIP019 	<ul style="list-style-type: none"> ■ ACTDIP011 ■ ACTDIP020 	<ul style="list-style-type: none"> ■ ACTDIK001 ■ ACTDIK007 ■ ACTDIK014
Prevent Flooding		<ul style="list-style-type: none"> ■ ACTDIP019 	<ul style="list-style-type: none"> ■ ACTDIP011 ■ ACTDIP020 	<ul style="list-style-type: none"> ■ ACTDIK007 ■ ACTDIK014
Drop and Rescue		<ul style="list-style-type: none"> ■ ACTDIP019 	<ul style="list-style-type: none"> ■ ACTDIP011 ■ ACTDIP020 	<ul style="list-style-type: none"> ■ ACTDIK007 ■ ACTDIK014
Sort to Recycle	<ul style="list-style-type: none"> ■ ACTDIP004 	<ul style="list-style-type: none"> ■ ACTDIP019 	<ul style="list-style-type: none"> ■ ACTDIP011 ■ ACTDIP020 	<ul style="list-style-type: none"> ■ ACTDIK001 ■ ACTDIK007 ■ ACTDIK014



Curriculum Overview Design and Technologies: Open Projects

■ Year F-2 ■ Year 3-4 ■ Year 5-6								
Project	Process and Production Skills					Knowledge and Understanding		
	<i>Investigating and defining</i>	<i>Generating and designing</i>	<i>Producing and implementing</i>	<i>Evaluating</i>	<i>Collaborating and managing</i>	<i>Technologies contexts</i>		<i>Technologies and Society</i>
						<i>Engineering principles and systems</i>	<i>Materials and technologies specialisation</i>	
Predator and Prey	■ ACTDEP024		■ ACTDEP007			■ ACTDEK002 ■ ACTDEK020		
Animal Expression	■ ACTDEP024		■ ACTDEP007			■ ACTDEK002 ■ ACTDEK020		
Extreme Habitats	■ ACTDEP024		■ ACTDEP007		■ ACTDEP009	■ ACTDEK002 ■ ACTDEK020		
Space Exploration	■ ACTDEP005 ■ ACTDEP014 ■ ACTDEP024	■ ACTDEP006 ■ ACTDEP015 ■ ACTDEP025	■ ACTDEP007 ■ ACTDEP016 ■ ACTDEP026	■ ACTDEP008 ■ ACTDEP017		■ ACTDEK002 ■ ACTDEK020	■ ACTDEK004 ■ ACTDEK013 ■ ACTDEK023	■ ACTDEK019
Hazard Alarm	■ ACTDEP005 ■ ACTDEP014 ■ ACTDEP024	■ ACTDEP006 ■ ACTDEP015 ■ ACTDEP025	■ ACTDEP007 ■ ACTDEP016 ■ ACTDEP026	■ ACTDEP008 ■ ACTDEP017	■ ACTDEP009	■ ACTDEK020	■ ACTDEK004 ■ ACTDEK013 ■ ACTDEK023	■ ACTDEK001 ■ ACTDEK010 ■ ACTDEK019
Cleaning the Oceans	■ ACTDEP005 ■ ACTDEP014 ■ ACTDEP024	■ ACTDEP006 ■ ACTDEP015 ■ ACTDEP025	■ ACTDEP007 ■ ACTDEP016 ■ ACTDEP026	■ ACTDEP008 ■ ACTDEP017			■ ACTDEK004 ■ ACTDEK013 ■ ACTDEK023	■ ACTDEK001 ■ ACTDEK010 ■ ACTDEK019
Wildlife Crossing	■ ACTDEP005 ■ ACTDEP014 ■ ACTDEP024	■ ACTDEP006 ■ ACTDEP015 ■ ACTDEP025	■ ACTDEP007 ■ ACTDEP016 ■ ACTDEP026	■ ACTDEP008 ■ ACTDEP017		■ ACTDEK020	■ ACTDEK004 ■ ACTDEK013	
Moving Materials	■ ACTDEP005 ■ ACTDEP014 ■ ACTDEP024	■ ACTDEP006 ■ ACTDEP015 ■ ACTDEP025	■ ACTDEP007 ■ ACTDEP016 ■ ACTDEP026	■ ACTDEP008 ■ ACTDEP017		■ ACTDEK002 ■ ACTDEK011 ■ ACTDEK020	■ ACTDEK004 ■ ACTDEK013 ■ ACTDEK023	■ ACTDEK001 ■ ACTDEK010



Curriculum Overview Digital Technologies: Open Projects

■ Year F-2 ■ Year 3-4 ■ Year 5-6					
Project	Process and Production Skills				Knowledge and Understanding
	<i>Investigating and defining</i>	<i>Generating and designing</i>	<i>Producing and implementing</i>	<i>Evaluating</i>	<i>Digital Systems</i>
Predator and Prey					<ul style="list-style-type: none"> ■ ACTDIK001 ■ ACTDIK007 ■ ACTDIK014
Animal Expression					<ul style="list-style-type: none"> ■ ACTDIK001 ■ ACTDIK007 ■ ACTDIK014
Extreme Habitats					<ul style="list-style-type: none"> ■ ACTDIK001 ■ ACTDIK007 ■ ACTDIK014
Space Exploration	<ul style="list-style-type: none"> ■ ACTDIP004 ■ ACTDIP010 	<ul style="list-style-type: none"> ■ ACTDIP019 	<ul style="list-style-type: none"> ■ ACTDIP011 ■ ACTDIP020 		<ul style="list-style-type: none"> ■ ACTDIK001 ■ ACTDIK007 ■ ACTDIK014
Hazard Alarm	<ul style="list-style-type: none"> ■ ACTDIP004 ■ ACTDIP010 	<ul style="list-style-type: none"> ■ ACTDIP019 	<ul style="list-style-type: none"> ■ ACTDIP011 ■ ACTDIP020 	<ul style="list-style-type: none"> ■ ACTDIP012 ■ ACTDIP021 	<ul style="list-style-type: none"> ■ ACTDIK001 ■ ACTDIK007 ■ ACTDIK014
Cleaning the Oceans	<ul style="list-style-type: none"> ■ ACTDIP004 ■ ACTDIP010 	<ul style="list-style-type: none"> ■ ACTDIP019 	<ul style="list-style-type: none"> ■ ACTDIP011 ■ ACTDIP020 		<ul style="list-style-type: none"> ■ ACTDIK001 ■ ACTDIK007 ■ ACTDIK014
Wildlife Crossing	<ul style="list-style-type: none"> ■ ACTDIP004 ■ ACTDIP010 	<ul style="list-style-type: none"> ■ ACTDIP019 	<ul style="list-style-type: none"> ■ ACTDIP011 ■ ACTDIP020 		<ul style="list-style-type: none"> ■ ACTDIK001 ■ ACTDIK007 ■ ACTDIK014
Moving Materials	<ul style="list-style-type: none"> ■ ACTDIP004 ■ ACTDIP010 	<ul style="list-style-type: none"> ■ ACTDIP019 	<ul style="list-style-type: none"> ■ ACTDIP011 ■ ACTDIP020 		<ul style="list-style-type: none"> ■ ACTDIK001 ■ ACTDIK007 ■ ACTDIK014



Curriculum Overview: Design and Technologies – Years F-2

Knowledge and Understanding	
Technologies contexts	
<i>Engineering principles and systems</i>	
ACTDEK002	Explore how technologies use forces to create movement in products
<i>Materials and technologies specialisation</i>	
ACTDEK004	Explore the characteristics and properties of materials and components that are used to produce designed solutions
Technologies and Society	
ACTDEK001	Identify how people design and produce familiar products, services and environments and consider sustainability to meet personal and local community needs
Process and Production Skills	
Investigating and defining	
ACTDEP005	Explore needs or opportunities for designing, and the technologies needed to realise designed solutions
Generating and designing	
ACTDEP006	Generate, develop and record design ideas through describing, drawing and modelling
Producing and implementing	
ACTDEP007	Use materials, components, tools, equipment and techniques to safely make designed solutions
Evaluating	
ACTDEP008	Use personal preferences to evaluate the success of design ideas, processes and solutions including their care for environment
Collaborating and managing	
ACTDEP009	Sequence steps for making designed solutions and working collaboratively



Curriculum Overview: Design and Technologies – Years 3-4

Knowledge and Understanding	
Technologies contexts	
<i>Engineering principles and systems</i>	
ACTDEK011	Investigate how forces and the properties of materials affect the behaviour of a product or system
<i>Materials and technologies specialisation</i>	
ACTDEK013	Investigate the suitability of materials, systems, components, tools and equipment for a range of purposes
Technologies and Society	
ACTDEK010	Recognise the role of people in design and technologies occupations and explore factors, including sustainability that impact on the design of products, services and environments to meet community needs
Process and Production Skills	
Investigating and defining	
ACTDEP014	Critique needs or opportunities for designing and explore and test a variety of materials, components, tools and equipment and the techniques needed to produce designed solutions
Producing and implementing	
ACTDEP016	Select and use materials, components, tools, equipment and techniques and use safe work practices to make designed solutions
Evaluating	
ACTDEP017	Evaluate design ideas, processes and solutions based on criteria for success developed with guidance and including care for the environment



Curriculum Overview: Design and Technologies – Years 5-6

Knowledge and Understanding	
Technologies contexts	
<i>Engineering principles and systems</i>	
ACTDEK020	Investigate how electrical energy can control movement, sound or light in a designed product or system
<i>Materials and technologies specialisation</i>	
ACTDEK023	Investigate characteristics and properties of a range of materials, systems, components, tools and equipment and evaluate the impact of their use
Technologies and Society	
ACTDEK019	Examine how people in design and technologies occupations address competing considerations, including sustainability in the design of products, services, and environments for current and future use
Process and Production Skills	
Investigating and defining	
ACTDEP024	Critique needs or opportunities for designing, and investigate materials, components, tools, equipment and processes to achieve intended designed solutions
Generating and designing	
ACTDEP025	Generate, develop and communicate design ideas and processes for audiences using appropriate technical terms and graphical representation techniques
Producing and implementing	
ACTDEP026	Select appropriate materials, components, tools, equipment and techniques and apply safe procedures to make designed solutions



Curriculum Overview: Digital Technologies – Years F-2

Knowledge and Understanding	
Digital Systems	
ACTDIK001	Recognise and explore digital systems (hardware and software components) for a purpose
Process and Production Skills	
Creating digital solutions by:	
Investigating and defining	
ACTDIP004	Follow, describe and represent a sequence of steps and decisions (algorithms) needed to solve simple problems



Curriculum Overview: Digital Technologies – Years 3-4

Knowledge and Understanding	
Digital Systems	
ACTDIK007	Identify and explore a range of digital systems with peripheral devices for different purposes, and transmit different types of data
Processes and production skills	
Creating digital solutions by:	
Investigating and defining	
ACTDIP010	Define simple problems, and describe and follow a sequence of steps and decisions (algorithms) needed to solve them
Producing and implementing	
ACTDIP011	Implement simple digital solutions as visual programs with algorithms involving branching (decisions) and user input
Evaluating	
ACTDIP012	Explain how student solutions and existing information systems meet common personal, school or community needs



Curriculum Overview: Digital Technologies – Years 5-6

Knowledge and Understanding	
Digital Systems	
ACTDIK014	Examine the main components of common digital systems and how they may connect together to form networks to transmit data
Processes and production skills	
Creating digital solutions by:	
Generating and designing	
ACTDIP019	Design, modify and follow simple algorithms involving sequences of steps, branching, and iteration (repetition)
Producing and implementing	
ACTDIP020	Implement digital solutions as simple visual programs involving branching, iteration (repetition), and user input
Evaluating	
ACTDIP021	Explain how student solutions and existing information systems are sustainable and meet current and future local community needs

Assess with WeDo 2.0

There are many ways to monitor and assess your students' progress through a WeDo 2.0 project. Here are some useful assessment tools:

- Anecdotal record grid
- Observation rubrics grid
- Documentation pages
- Self-assessment statements





Teacher-led assessment

Developing students' science and engineering practices takes time and feedback. Just as in the design cycle, in which students should know that failure is part of the process, assessment should provide feedback to students in terms of what they did well and where they can improve.

Problem-based learning is not about succeeding or failing. It is about being an active learner and continually testing and building upon ideas.

Anecdotal record grid

The anecdotal record grid lets you record any type of observation you believe is important about each student. Use the template on the next page to provide feedback to students about their learning progress as required.

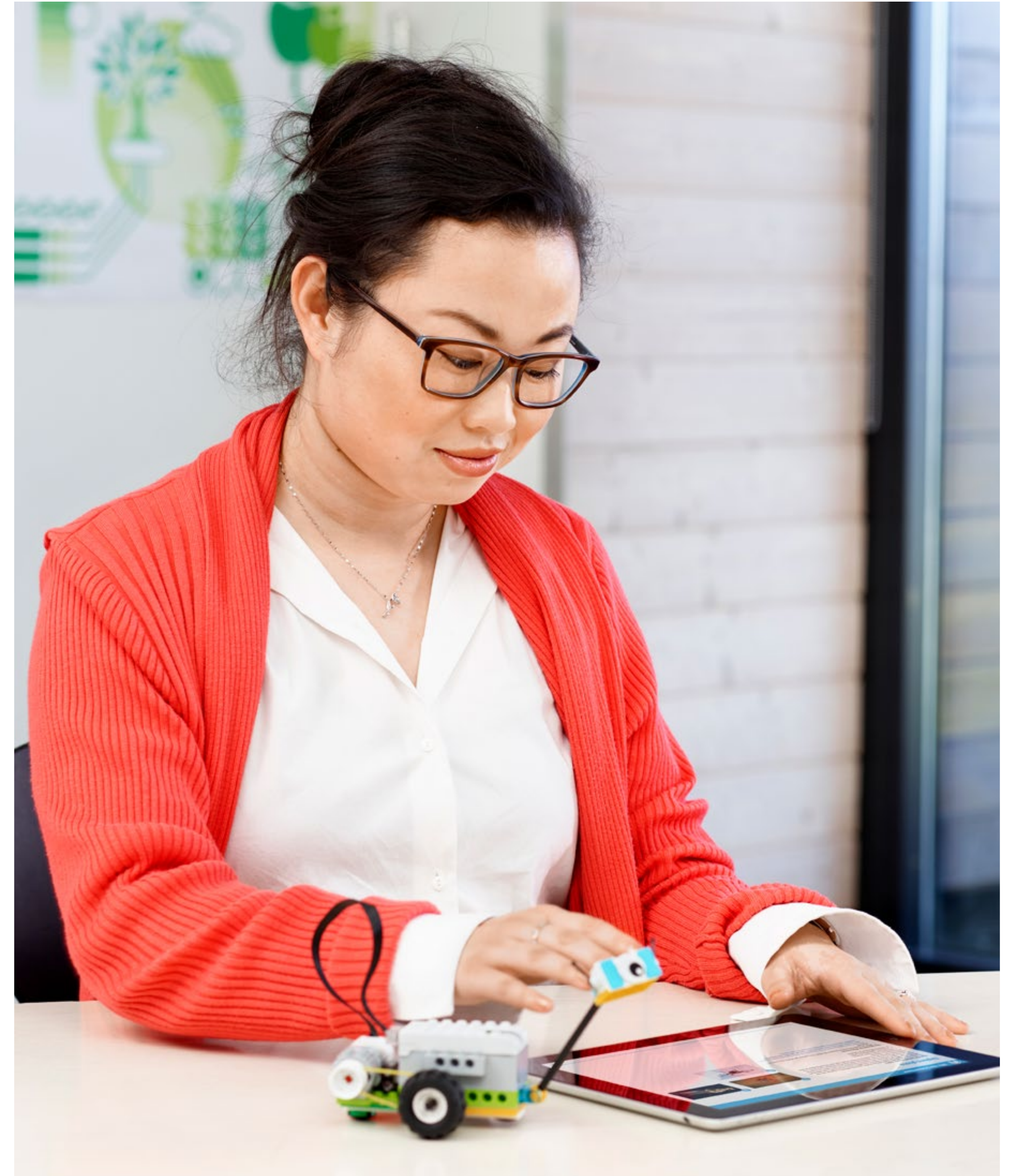



Anecdotal record grid

Name: _____ Class: _____ Project: _____

Emerging	Developing	Proficient	Accomplished

Notes:



Teacher-led assessment

Observation rubrics

An example rubrics has been provided for every Guided Project. You can use the observation rubrics grid to:

- Evaluate student/team performance at each step of the process.
- Provide constructive feedback to help the student/team to progress.

Observation rubrics provided in the Guided Projects can be adapted to fit your needs. The rubrics are based on these progressive stages:

1. Emerging

The student is at the beginning stages of development in terms of content knowledge, ability to understand and apply content, and/or demonstration of coherent thoughts about a given topic.

2. Developing

The student is able to present basic knowledge only (vocabulary, for example), and cannot yet apply content knowledge or demonstrate comprehension of concepts being presented.

3. Proficient

The student has concrete levels of comprehension of content and concepts and can demonstrate adequately the topics, content, or concepts being taught. The ability to discuss and apply outside the required assignment is lacking.

4. Accomplished

The student can take concepts and ideas to the next level, apply concepts to other situations, and synthesise, apply, and extend knowledge to discussions that include extensions of ideas.

▶ Suggestion

You can use the observation rubrics grid on the next page to keep track of your students' progress.





Observation rubrics grid

Class:		Project					
Students' names		Scientific understanding			Presentation and problem-solving		
		Explore	Create	Share	Explore	Create	Share
1							
2							
3							
4							
5							
6							
7							
8							
9							
10							
11							
12							
13							
14							
15							

To be used with the rubrics description in the “Guided Projects” chapter (1. Emerging, 2. Developing, 3. Proficient, 4. Accomplished).



Student-led assessment

Documentation pages

Each project will ask students to create documents to summarise their work.

To have a complete science report, it is essential that students:

- Document with various types of media.
- Document every step of the process.
- Take the time to organise and complete their documents.

It is most likely that the first document your students complete will not be as good as the next one:

- Allow them time and feedback to see where and how they can improve it.
- Ask your students to share their documents with each other. By communicating their scientific findings, students are engaged in the work of scientists.

Self-assessment statements

After each project, students can reflect on the work they have done. Use the following page to encourage reflection and set goals for the next project.





Student self-assessment rubric

Name: _____

Class: _____

Project: _____

	Explore	Create	Share
	I documented and used my best reasoning in connection with the question or problem.	I did my best work to solve the problem or question by building and programming my model and making changes when needed.	I documented important ideas and evidence throughout my project and did my very best when presenting to others.
1			
2			
3			
4			

Project reflection

One thing I did really well was: _____

One thing I want to improve on for next time is: _____

Classroom Management

In this chapter, you will find information and guidance to help with the implementation of WeDo 2.0 in your classroom.

The secret for success resides in these key elements:

- Good material preparation
- Good classroom disposition
- Good WeDo 2.0 project preparation
- Good guidance of students





Prepare the material

1. Install the software on the computers or tablets.
2. Open each LEGO® Education WeDo 2.0 Core Set and sort the elements.
3. Attach the labels to the relevant sorting tray compartments.
4. It is a good idea to label the box, Smarthub, motor, and sensors with a number.
That way, you can assign a numbered kit to each student or team. You may find it helpful to also display the parts list in the classroom.
5. Put two AA batteries in the Smarthub or use the supplementary Smarthub rechargeable battery.

Suggestion

To improve your classroom experience, it is recommended that you allocate a name, from the list in the Connection Centre, to each Smarthub.

When you access the Connection Centre:

1. Press the button on the Smarthub.
2. Locate the Smarthub name in the list.
3. Long Press on the name you wish to change.
4. At this point, you will be able to enter a name of your choice.

You can insert names following a code, such as:

- WeDo-001,
- WeDo-002,
- etc.

This will make it easier for the students to locate and connect with the right Smarthub.



Before you start a project

Classroom disposition

1. Designate a cabinet, storage trolley, or other space for storing the sets between sessions.
2. If not already available in your classroom, prepare a box of measuring tools, such as rulers or tape measures, and paper for collecting data and making charts.
3. Ensure that there is enough space in the classroom for the project to take place.
4. When planning the projects, ensure that there is enough time for the students to put their models and parts away at the end of each session.

Teacher preparation

1. Spend some time exploring the bricks in the WeDo 2.0 set, and determine key expectations for classroom use.
2. Set aside an hour to try the Getting Started Project, as if you were one of the students.
3. Read the overview and projects description in the “Open Projects” chapter and select the project you wish to complete.
4. Review the planning of the project you have selected.

Now you're ready to go!





Student guidance

It is important to establish good classroom management habits when working with the WeDo 2.0 sets and digital devices.

It may be helpful to establish clear expectations for team roles:

- WeDo 2.0 projects are optimal for a team of two students working together.
- Ask the students to work to their strengths within their groups.
- Make adjustments to suit teams who are ready to develop new skills and improve further.
- Assign, or ask the students to determine, specific roles for each team member.

Suggestion

Assign a role to each student so that the team can foster collaboration and cooperation skills. Here are a few ideas/examples:

- Selector – chooses the bricks
- Builder – assembles the bricks
- Programmer – creates the program strings
- Documenter – takes photographs and videos
- Presenter – explains the project
- Team captain

It is also a good idea to rotate roles. This allows the students to experience all of the components involved in each project, and will help them to develop a wider range of skills.

Getting Started Projects

Milo the Science Rover

51-54



Milo's Motion Sensor

55-57



Milo's Tilt Sensor

58-59



Collaborate

60-61



Getting Started Project - Part A

Milo the Science Rover

This project is about discovering ways that scientists and engineers can use rovers to explore places where humans cannot go.





Quick glance: Getting Started Project, part A

Preparation: 30 min.

- For information regarding general preparation, please see the “Classroom Management” chapter.
- Read through this project so you have a good idea of what to do.
- Prepare to introduce this project to your students.
- Define your expectations and theirs.
- Determine the end result of this project: Everyone should have a chance to build, program, and document.
- Make sure that timing allows for expectations to be met.

Explore phase: 10 min.

- Start the project using the introductory video.
- Have a group discussion.

Create phase: 20 min.

- Ask the students to build the first model from the provided building instructions.
- Ask them to program the model using the sample program.
- Allow students time so they can make their own experiments and change the parameters of the program.
- Challenge them to discover new programming blocks on their own.

Share phase: 10 min.

Some suggestions for sharing include:

- Make sure your students take photographs of their models.
- Make sure they write their names and comments in the Documentation tool.
- Ask the students to export the results of their projects and share them with their parents.

▶ Important

It is recommended that you complete the four Getting Started Projects in a single sequence. If not, it is recommended that you complete these before moving on to other projects. This will give the students ample time to explore the materials.

Approximate timing for the four Getting Started Projects is:

- Part A: Milo the Science Rover: 40 min.
- Part B: Milo’s Motion Sensor: 15 min.
- Part C: Milo’s Tilt Sensor: 15 min.
- Part D: Collaborate: 15 min.



Explore phase

Use the introductory video

Scientists and engineers have always challenged themselves to explore remote places and make new discoveries. To make this possible, they have designed spacecraft, rovers, satellites, and robots that enable them to collect data and make visual observations of previously inaccessible places. They have succeeded many times, but have also failed many times. Remember that failure presents a chance to learn. Use the following ideas to start thinking like a scientist:

1. Scientists send rovers to Mars.
2. They use submarines in water.
3. They fly drones into volcanoes.

Questions for discussion

1. What do scientists and engineers do when they cannot go where they want to explore?

Scientists and engineers see these situations as challenges that need to be overcome. With proper resources and commitment, they will develop prototypes of possible solutions and ultimately choose the best option.

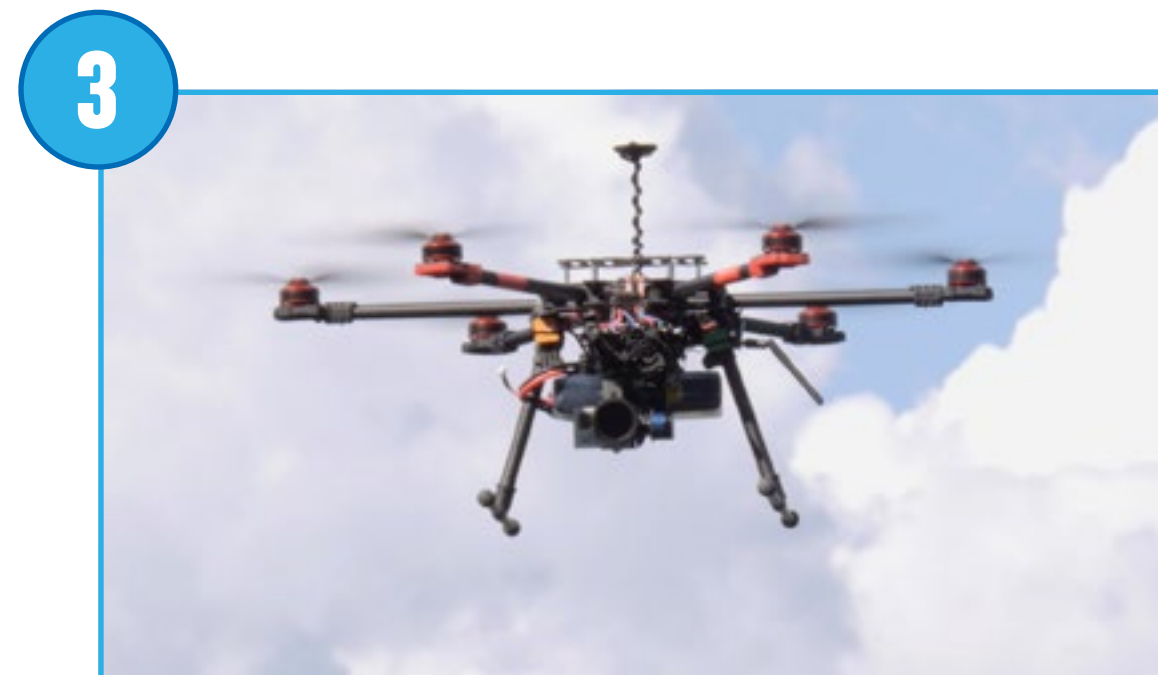
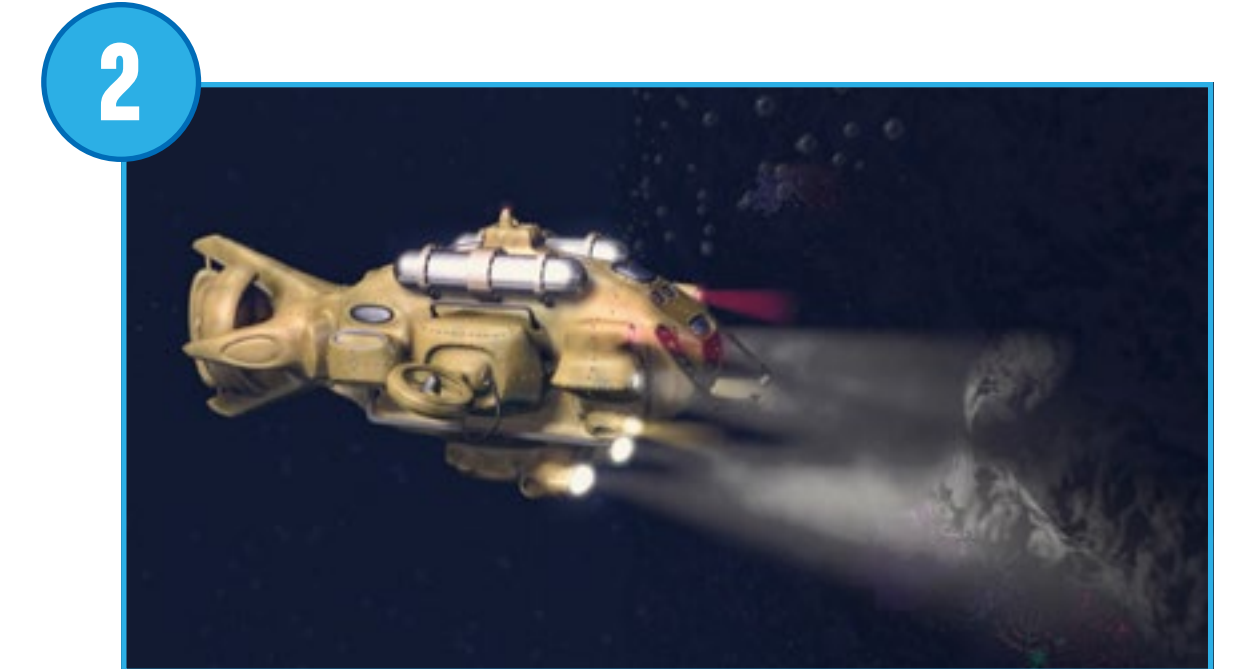
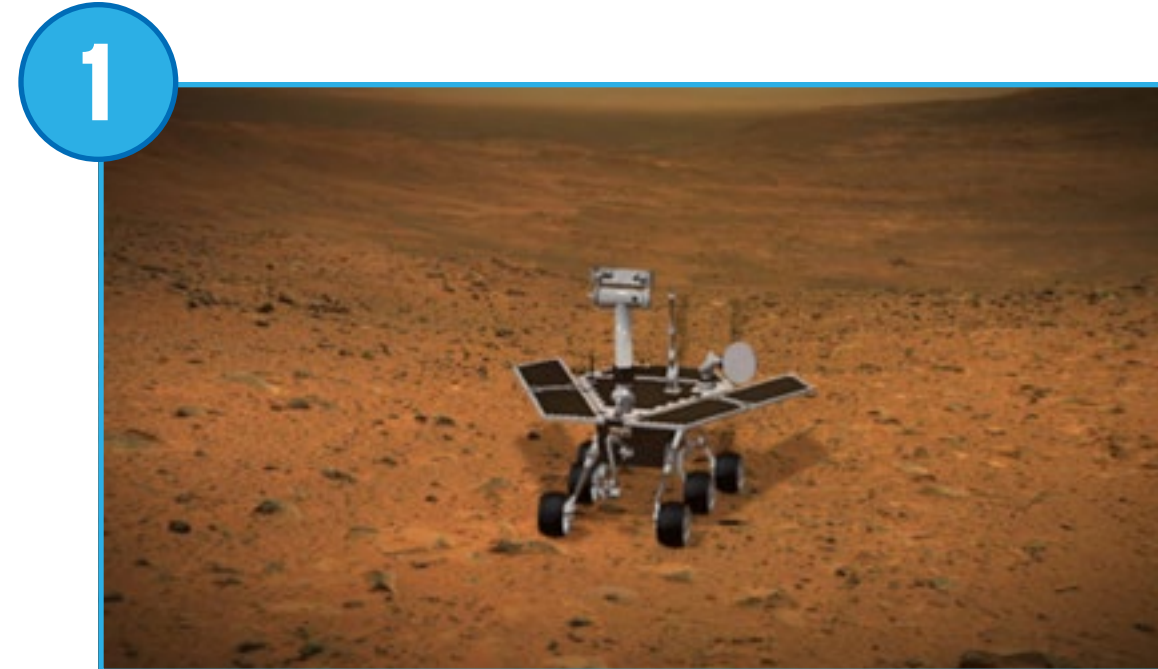



Create phase

Build and program Milo

Students should follow the building instructions to build Milo the Science Rover.

1. Build Milo the Science Rover.

This model will give students a “first build” experience with WeDo 2.0.

▶ Important

Make sure everyone can connect the motor to the Smarthub, and the Smarthub to the device.

2. Program Milo.

This program will start the motor at power eight, travel in one direction for two seconds, and then stop.

The motor can be started in both directions, stopped and turned at different speeds, and activated for a specific amount of time (specified in seconds).

▶ Suggestion

Give students time to change the parameters of this program string. Let them discover new features, such as adding sound.

Use this opportunity to guide students to the Design Library, where they can find inspiration to explore other program strings.





Share phase

Present

Before you move on to the next part of the Getting Started Project, allow the students to express themselves:

- Have a short discussion with your students about scientific and engineering instruments.
- Ask your students to describe how science rovers are helpful to humans.

Document

- Introduce the students to the Documentation tool.
- Ask them to take photographs of themselves together with their models.

Getting Started Project - Part B

Milo's Motion Sensor

In this section, students will be introduced to the use of the Motion Sensor to detect the presence of a special plant specimen.

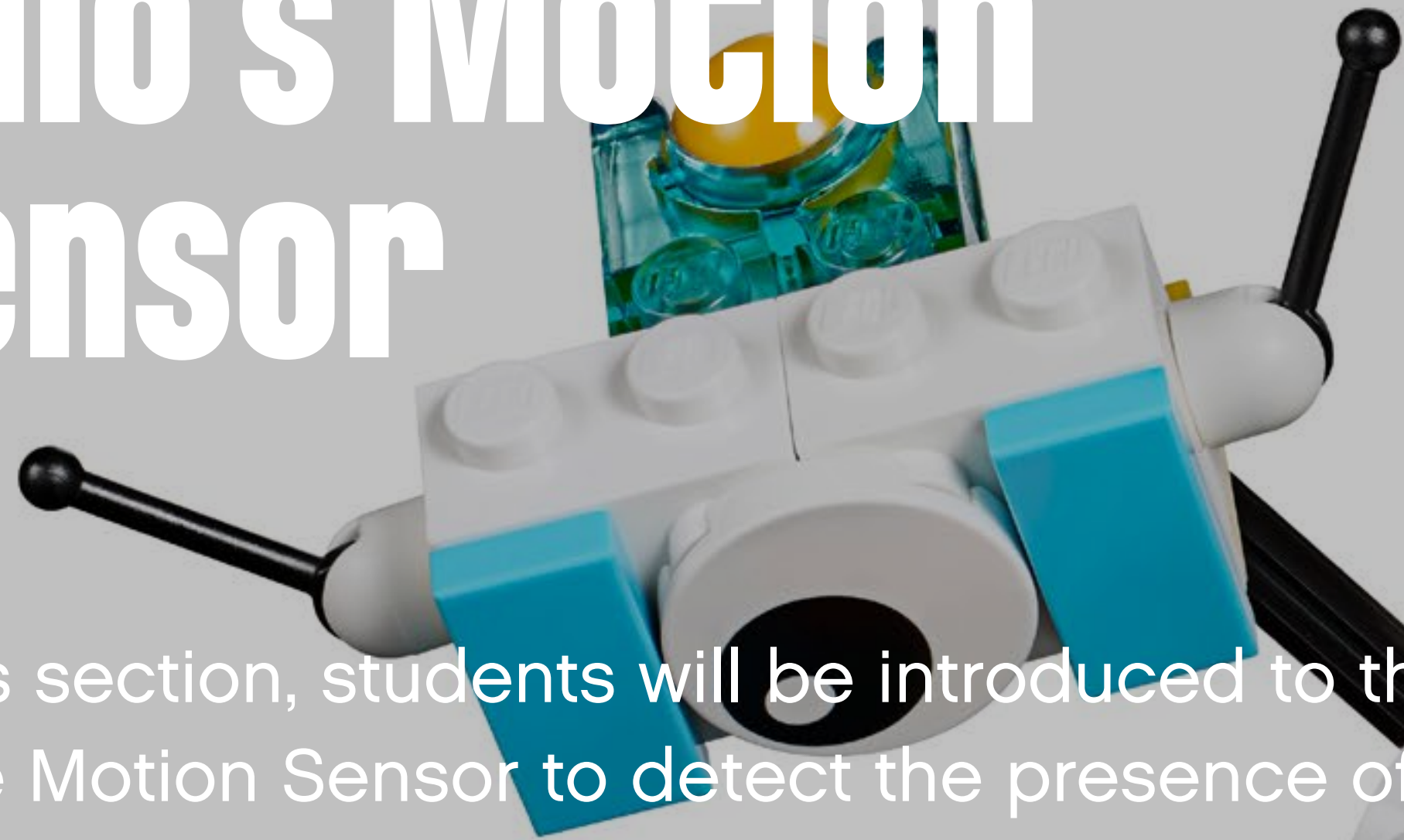



Using a Motion Sensor

Explore phase

Rovers sent to remote locations need to have sensors so that they can complete tasks without the need for constant human attention.

Questions for discussion

1. How are science instruments important to the tasks that scientists have to complete?

Rovers are fitted with sensors that tell them when to move and when to stop. This makes them suitable for carrying out research in remote locations.

Create phase

Your students will follow the provided building instructions to create a robotic arm that incorporates the Motion Sensor, making it possible for Milo to detect the plant sample. They will also build a plant sample on a LEGO® round plate.

The provided program string will make the rover move forward until it detects the presence of the sample object. It will then stop and make a sound.

Ask the students to record a sound that will signify the rover's discovery.

Share phase

Ask your students to record a video of their mission. They will practice using the camera and recording themselves, which will be useful for future projects.



Getting Started Project - Part C

Milo's Tilt Sensor

In this section, students will be introduced to the use of the Tilt Sensor to help Milo send a message to the base.





Introduce the use of a Tilt Sensor

Explore phase

When rovers locate what they are looking for, they send a message back to the base.

Questions for discussion

1. Why is communication between a rover and its base so important?

If a rover successfully completes a series of tasks, but fails to send back the results, the mission will be deemed a failure. A communication link between the remote rover and the base is essential.

2. How do we communicate with rovers?

Currently, satellites are used to transmit radio signals between the base and the rover.

Create phase

Using the Tilt Sensor and the provided building instructions, your students will build a device that can send a message back to the base.

The program string will trigger two actions, depending on the angle detected by the Tilt Sensor:

- If tilted down, the red LED will light up.
- If tilted up, a text message will appear on the device.

Share phase

Make sure that each student takes a screenshot of their final program. Ask them to practise documenting the program strings they used in their project.



Getting Started Project - Part D

Collaborate

In this section, students will be introduced to the importance of collaborating during projects.

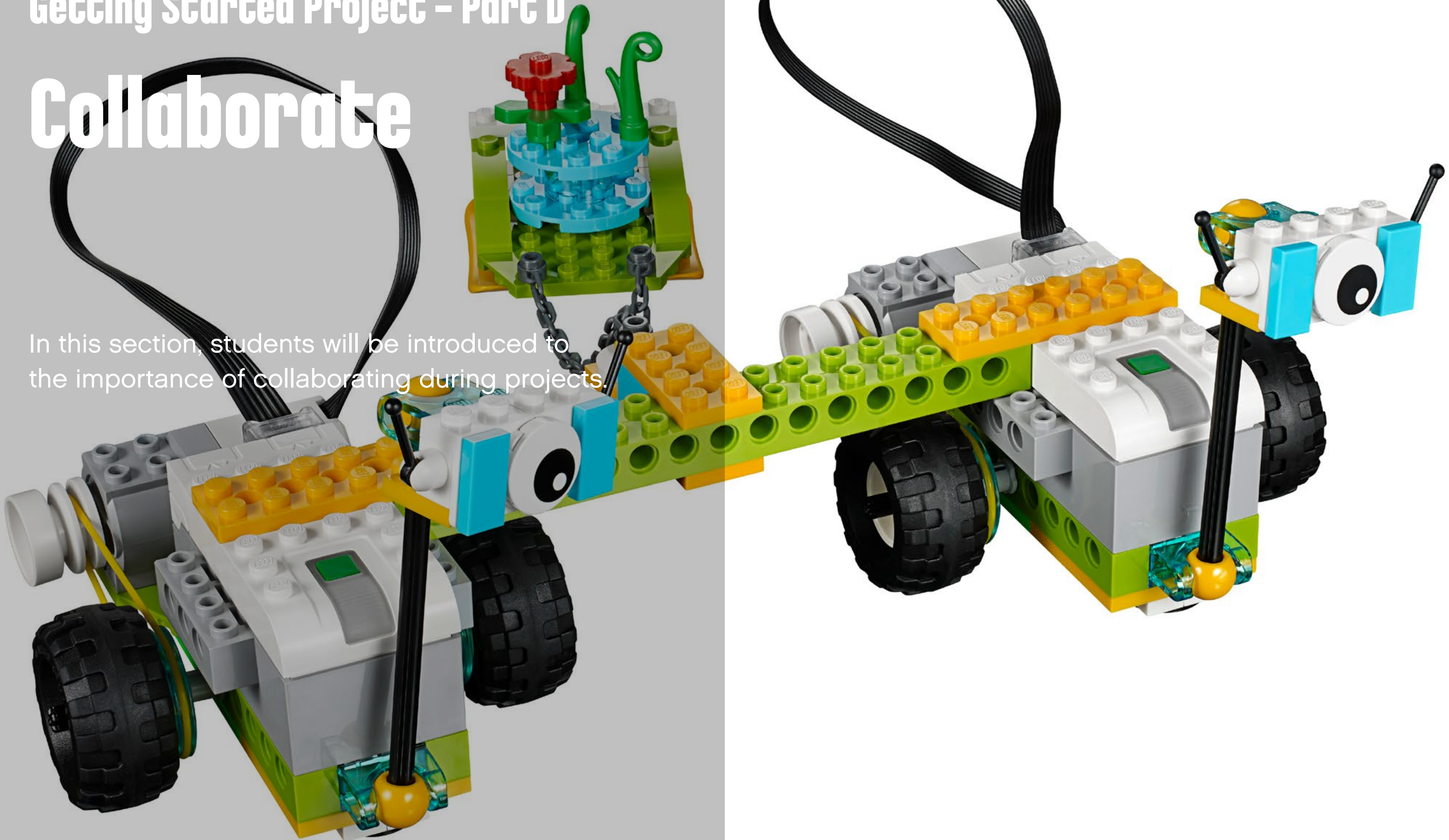

Collaborate with other rovers

Explore phase

Now that your rover has found the plant sample, it is time to carry it back. But wait... it might be too heavy! Let's see if you can collaborate with another rover to move the sample forward together.

Create phase

Pair up the teams to complete this final part of the mission:

1. Ask them to build the transportation device, physically connecting the two rovers together.
2. Let students create their own program strings to move the specimen from a point A to a point B. Students could use the program strings shown below.
3. When everyone is ready, ask the teams to carefully move their plant samples.

▶ Suggestion

Note that you can connect up to three Smarthubs to the same tablet; for teams working on their own. See the "Toolbox" chapter for instructions.

Share phase

Ask the students to discuss their experiences:

- Why is it important to collaborate when solving a problem?
- Give an example of good communication among teams.

Finally, ask the students to complete their documents with the Documentation tool while collecting and organising important information.

▶ Important

Because not all the WeDo motors are the same, teams will have to collaborate in order to succeed.



Guided Projects overview

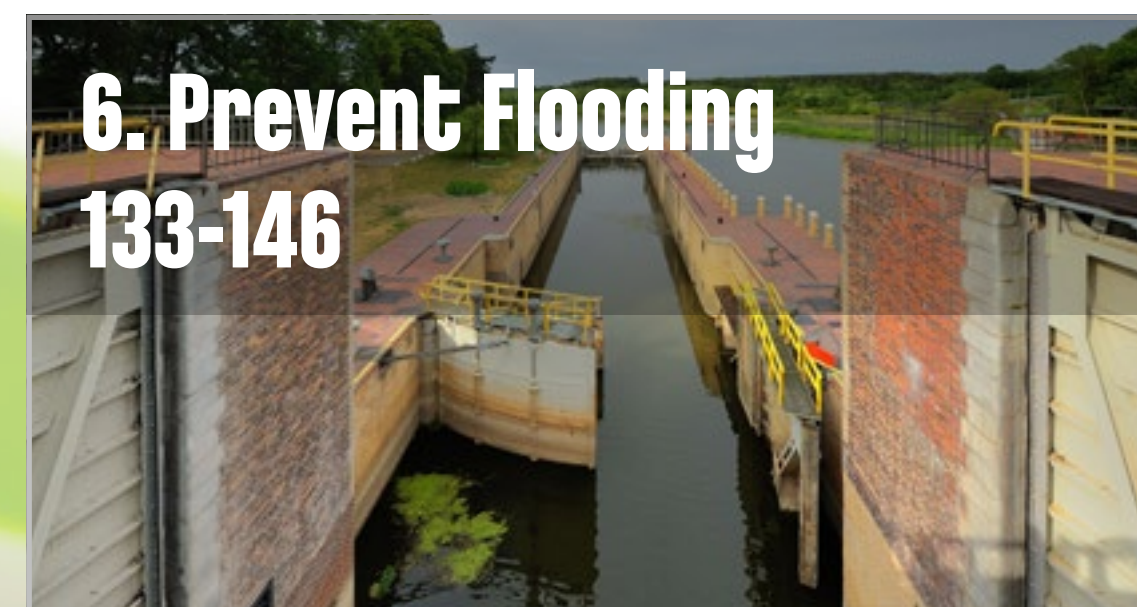
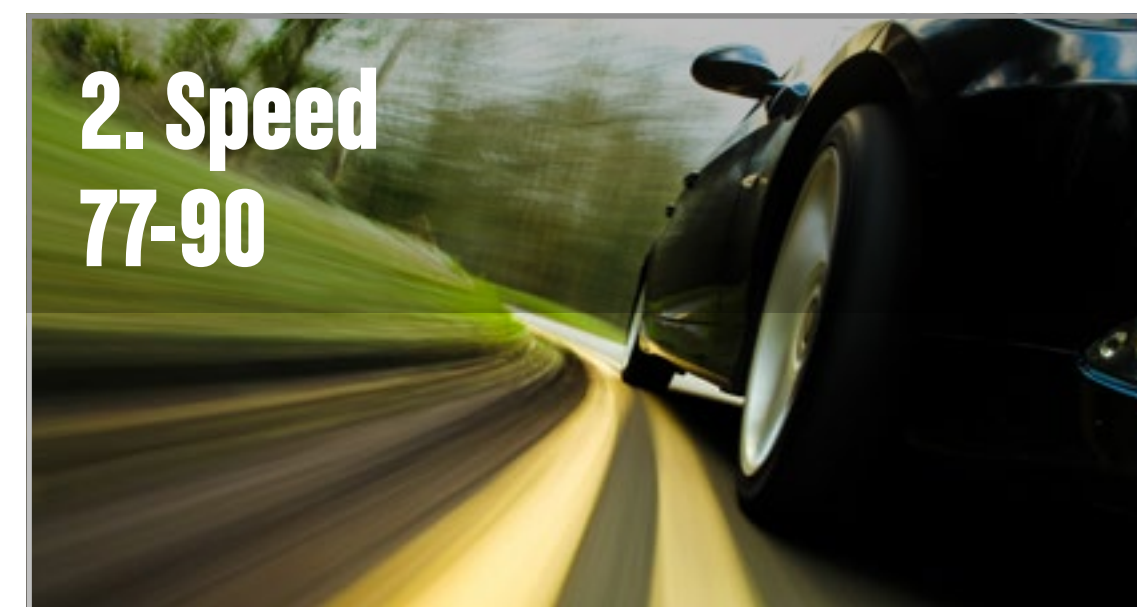
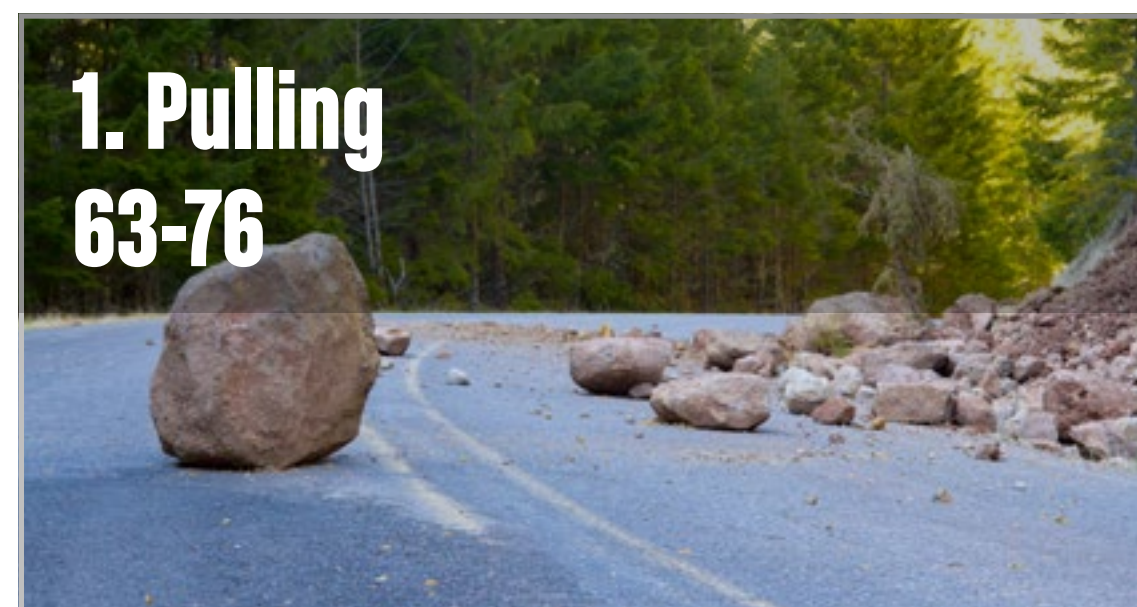

Project 1

Pulling

This project is about investigating the effects of balanced and unbalanced forces on the movement of an object.





Curriculum links

Australian Curriculum: Science

Science Understanding

ACSSU033: A push or a pull affects how an object moves or changes shape

ACSSU076: Forces can be exerted by one object on another through direct contact or from a distance

Science as a Human Endeavour

ACSHE034: Science involves observing, asking questions about, and describing changes in, objects and events

ACSHE061: Science involves making predictions and describing patterns and relationships

Science Inquiry Skills

AC SIS037: Pose and respond to questions, and make predictions about familiar objects and events

AC SIS064: With guidance, identify questions in familiar contexts that can be investigated scientifically and make predictions based on prior knowledge

AC SIS038: Participate in guided investigations to explore and answer questions

AC SIS065: With guidance, plan and conduct scientific investigations to find answers to questions, considering the safe use of appropriate materials and equipment

AC SIS216: Compare results with predictions, suggesting possible reasons for findings

AC SIS041: Compare observations with those of others

AC SIS069: Reflect on the investigation; including whether a test was fair or not

AC SIS042: Represent and communicate observations and ideas in a variety of ways

AC SIS071: Represent and communicate observations, ideas and findings using formal and informal representations





Curriculum links

Other Curriculum links

Australian Curriculum: Technologies Design and Technologies

Knowledge and Understanding

ACTDEK002: Explore how technologies use forces to create movement in products

ACTDEK011: Investigate how forces and the properties of materials affect the behaviour of a product or system

ACTDEK020: Investigate how electrical energy can control movement, sound or light in a designed product or system

Processes and Production Skills

ACTDEP007: Use materials, components, tools, equipment, and techniques to safely make designed solutions

ACTDEP016: Select and use materials, components, tools, equipment, and techniques, and use safe work practices to make designed solutions

ACTDEP024: Critique needs or opportunities for designing, and investigate materials, components, tools, equipment, and processes to achieve intended designed solutions

Digital Technologies

Knowledge and Understanding

ACTDIK001: Recognise and explore digital systems (hardware and software components) for a purpose

ACTDIK007: Identify and explore a range of digital systems with peripheral devices for different purposes, and transmit different types of data

ACTDIK014: Examine the main components of common digital systems and how they may connect together to form networks to transmit data

Processes and Production Skills

ACTDIP004: Follow, describe, and represent a sequence of steps and decisions (algorithms) needed to solve simple problems

ACTDIP010: Define simple problems, and describe and follow a sequence of steps and decisions (algorithms) needed to solve them

ACTDIP011: Implement simple digital solutions as visual programs with algorithms involving branching (decisions) and user input

ACTDIP019: Design, modify, and follow simple algorithms involving sequences of steps, branching, and iteration (repetition)

ACTDIP020: Implement digital solutions as simple visual programs involving branching, iteration (repetition), and user input



Quick glance: Plan this WeDo 2.0 project

Preparation: 30 min.

- Read about general preparation in the “Classroom Management” chapter.
- Read about the project so you have a good idea of what to do.
- Define how you want to introduce this project: Use the video provided for the project in the WeDo 2.0 Software, or use material of your own choice.
- Determine the end result of this project: the parameters to present and produce the document.
- Make sure that timing allows for expectations to be met.

► Important

This project is an investigation; please refer to the “WeDo 2.0 in Curriculum” chapter for further explanations of investigative practices.

Explore phase: 30-60 min.

- Start the project using the introductory video.
- Hold a group discussion.
- Allow the students to document their ideas for Max and Mia’s questions using the Documentation tool.

Create phase: 45-60 min.

- Ask the students to build the first model using the provided building instructions.
- Allow them to program the model using the sample program.
- Allow them time to test different combinations with different objects. Explain what is happening in terms of balanced and unbalanced forces.

Create more phase (optional): 45-60 min.

- You can use this extension of the project for differentiation or for older students.

Share phase: 45 min. or more

- Make sure your students document the results of each test.
- Ask the students to share their findings based on the information gathered during their investigations.
- Ask them to predict the outcome resulting from the addition of weight.
- Ask the students to create their final presentations.
- Find different ways to let the students share their results.
- Ask the students to present their projects.

► Suggestion

Have a look at the following “Open Projects” when you have completed this project:

- [Cleaning the Oceans](#)
- [Space Exploration](#)



Differentiation

It is recommended that you start with this project.

To ensure success, consider giving more guidance on building and programming, such as:

- Explain the use of motors.
- Explain simple program strings.
- Explain how to conduct an investigation.
- Define factors to focus on, such as pull and friction forces.

Be specific about how you would like them to present and document their findings. For example, a team sharing session.

Investigate more

For an additional challenge, allow extra time for experimentation with student-created design, building, and programming. This will allow them to explore the additional laws of push and pull.

To extend the investigation, ask your students to compare the strength of their robots by pairing them in a tug-of-war contest. Prepare for the excitement!

Students' misconceptions

Students are likely to believe that if something is not moving, there are no forces acting upon it. A good example to demonstrate this is trying to move a car when the handbrake is on. Because the car is not moving, students tend to believe that there are no forces involved, yet there is. Scientifically, it's understood that several balanced forces are at work.

Vocabulary

Force

Push or pull upon an object

Net force

Overall force acting on an object

Friction

The resisting force when two objects are in contact

Static friction

Force that occurs when two objects are not moving relative to one another (example: a desk on a floor)

Rolling friction

Force that occurs when one object rolls on another (example: car wheels on a road)

Kinetic friction or sliding friction

Force that occurs when two objects are moving relative to one other and rub together (example: a sledge on snow)

Equilibrium

The condition in which all forces are balanced or cancelled by equal opposing forces. In other words, when net force equals 0.



Scientific understanding assessment rubrics

You can use these assessment rubrics with the observation rubrics grid, which you can find in the “Assess with WeDo 2.0” chapter.

Explore phase

During the Explore phase, make sure each student is actively involved in the discussion, asks and answers questions, and correctly uses the terms push and pull, forces, and friction.

1. The student is unable to provide answers to questions, participate in discussions, or adequately describe the ideas of “push and pull” and relate to them as forces.
2. The student is able, with prompting, to adequately provide answers to questions or participate in discussions, or with help, describe “push and pull” as an example of force.
3. The student is able to provide adequate answers to questions, participate in class discussions, or describe push and pull as an example of force.
4. The student is able to extend explanations in discussion or describe in detail the concept of force with push and pull.

Create phase

During the Create phase, make sure that each student is working as part of a team, can make predictions about events, and can use the information gathered during the Explore phase.

1. The student is unable to work as part of a team, make predictions about events, or use gathered information.
2. The student is able to work as part of a team and predict, with help, what might happen during the investigation.
3. The student is able, with guidance, to gather and use information, work as part of a team, contribute to team discussions, make predictions, and gather information to use in a presentation.

4. The student is able to work as part of a team, serve as the leader, and use gathered information to justify predictions that explain the forces of push and pull.

Share phase

During the Share phase, make sure that each student can explain what is happening with their model in terms of force, has tested different combinations and can predict others, and can use important information from the project to create a final report.

1. The student is unable to engage in the discussion about the investigation, explain the model using the concept of force, or use information to create a final project.
2. The student is able, with prompting, to engage in the discussion about forces, complete multiple testing scenarios in order to make predictions, and use limited information to create a final project.
3. The student is able to engage in discussions about the investigation of forces and use the information gathered during testing to produce a final project.
4. The student is able to engage extensively in class discussions about the topic, and use the information gathered to create a final project that includes additional elements.



Presentation and problem-solving assessment rubrics

You can use these assessment rubrics with the observation rubrics grid, which you can find in the “Assess with WeDo 2.0” chapter.

Explore phase

During the Explore phase, make sure that each student can effectively explain their own ideas and comprehension in relation to the questions posed.

1. The student is unable to share his/her ideas in relation to the questions posed during the Explore phase.
2. The student is able, with prompting, to share his/her ideas in relation to the questions posed during the Explore phase.
3. The student adequately expresses his/her ideas in relation to the questions posed during the Explore phase.
4. The student uses details to extend explanations of his/her ideas in relation to the questions posed during the Explore phase.

Create phase

During the Create phase, make sure that each student makes appropriate choices (i.e., screenshot, image, video, text) and follows the established expectations for documenting their findings.

1. The student fails to document findings throughout the investigation.
2. The student documents his/her findings, but the documentation is incomplete or does not comply with all of the established expectations.
3. The student adequately documents findings for each part of the investigation and makes appropriate choices and selections.
4. The student uses a variety of appropriate methods for documentation and exceeds the established expectations.

Share phase

During the Share phase, make sure that each student uses the evidence that they gathered during their investigations to justify their reasoning, and that they adhere to established guidelines when presenting their findings to an audience.

1. The student does not use evidence from his/her findings during the presentation or does not follow established guidelines.
2. The student uses some evidence from his/her findings, but the justification is limited. In general, established guidelines are followed, but may be lacking in one or more areas.
3. The student adequately provides evidence to justify his/her findings and follows established guidelines for presenting.
4. The student fully discusses his/her findings and thoroughly utilises appropriate evidence to justify his/her reasoning, while following all established guidelines.



Explore phase

The introductory video may set the stage for the following ideas to be reviewed and discussed with students.

Introductory video

It has been a long time since humans first attempted to move large objects around. From ancient civilisations to the modern age, various tools have been used to push or pull objects.

1. When you do not succeed in pulling something, it is because it is being pulled in the opposite direction with the same or a greater amount of force.
2. When an object starts to move, the force is greater in the direction of the movement.
3. On earth, friction has a role to play.
4. It is easier to pull a weight along a smooth surface than it is along a rough surface, due to the reduction in friction.

The topic of force and motion was explored and explained in detail by Sir Isaac Newton in the 17th century. You experience the laws of physics, that Newton defined, on a daily basis.

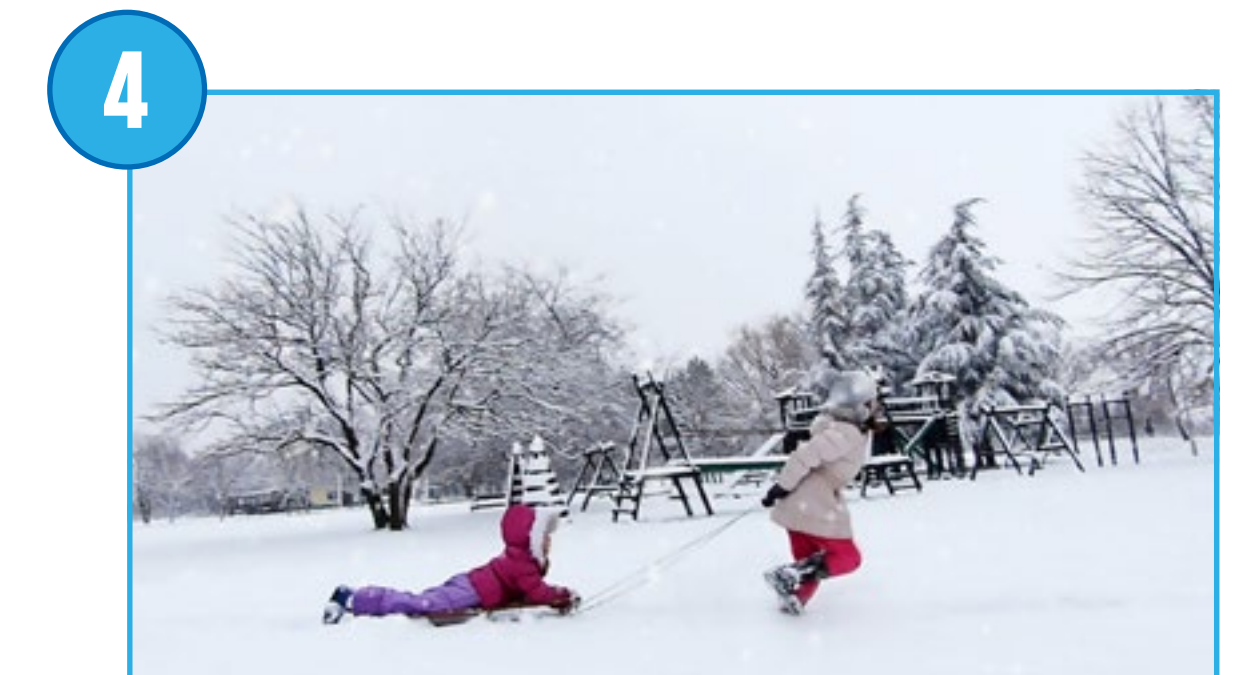



Explore phase

Questions for discussion

1. Name different ways in which an object can be moved.
To make it move, pull or push it, or, more generally, apply a force to it.
2. Can you explain friction? Is it easier to pull something on a normal surface than on a slippery one?
This question refers to friction. It is easier to move an object on a slippery surface than on a rough one.
Depending on the mass of an object, it can also be more difficult to move the object on a slippery surface, because there is less grip to push or pull it.
3. Predict what will happen if the pull force is greater in one direction than the other.
This answer should be based on students' predictions. This means that at this point, your students' answers may be incorrect. After the lesson, students should be able to discuss the fact that the motion of an object depends on the direction of the greater force.

Ask your students to collect their answers with text or pictures in the Documentation tool.

Other questions to explore

1. Can you describe the relationship between balanced forces and an object's ability to move?
Unbalanced forces can cause a change in an object's motion (speeding up, slowing down, etc.)



Create phase

Build and program a Pull-robot

Students will follow the building instructions to create a Pull-robot. The Pull-robot will pull various objects that are placed in its basket. This investigation can be carried out on various types of surfaces, such as wood or carpet. Use the same surface for the entire project.

1. Build a Pull-robot.

The wobble module featured in this project uses a bevel gear. This bevel gear changes the axis of rotation, from vertical to horizontal, bringing the motion from the motor to the wheels.

The basket has sliding bricks to reduce friction.

2. Program the robot to pull an object.

This program will display a 3, 2, 1 countdown before the motor turns on for two seconds at motor power 10.

▶ Suggestion

Before your students begin their investigations, ask them to adjust the parameters of the program so that they fully understand it.





Create phase

Test the Pull-robot

Using this model, students should be able to conduct an investigation about pull forces.

1. Investigate by adding light objects and then heavy objects to the basket until the device stops moving.

It will take around 300 grams on a regular surface to stop the Pull-robot from moving. Students can use any object, but nothing too heavy, as the goal is to reach equilibrium. At that point, students have balanced forces in front of them. You can use an arrow to symbolise the direction of the force.

You can also use the small tyres as objects to place in the basket. They will increase the friction on the basket side.

2. With the same amount of bricks in the basket, put the large tyres on the model and carry out tests.

Ask the students to put the tyres on the Pull-robot. This will cause the friction between the wheels and the surface to be greater on the Pull-robot side, increasing the force pulling in that direction. The system will suddenly become unbalanced.

This evidence supports the idea that when a pull force is greater than opposing forces, objects should move.

3. Find the heaviest object you can pull with your model when it is fitted with tyres.

This final step will depend on the friction of the surface.





Create phase

Use the “Investigate more” section of the student project as an optional extension. Keep in mind that these tasks are an extension of the “Investigate” section and are designed for older or more advanced students.

Investigate more

The Pull-robot that students are working with uses a bevel gear mechanism to change the direction of the motor rotation. It does not greatly increase the strength of the movement.

1. Build a different Pull-robot.

Ask the students to explore new designs for a pull machine. Ask them to build their own models, carry out the same tests as with their original Pull-robot, and compare the results of the two investigations. The students can refer to the Design Library for inspiration.

Collaboration suggestion

Find the most powerful machine in the classroom

When the students have finished their tests, organise a tug of war contest:

- Pair up two teams.
- Attach the robots back-to-back with the LEGO® chain.
- Ask the teams to place equal amounts of weight and mass in the baskets before starting the contest.
- Tell them to start their motors at your signal, so that they pull away from each other. Which is the strongest?





Share phase

Complete the document

Ask the students to document their projects in different ways:

- Ask them to take screenshots of their results.
- Ask them to compare images of their models with real-life images.
- Ask them to record project presentation videos.

Suggestions

Students may collect data in a chart format or on a spreadsheet.

Students may also graph the results of their tests.

Present results

At the end of this project, students should present the results of their investigations.

To enhance your students' presentation:

- Make sure students use words like balanced force, unbalanced force, push, pull, friction, and weight.
- Ask them to use arrows to represent force.
- Ask them to put their explanations into context.
- Ask them to analyse their projects in terms of real-life situations in which they have observed balanced and unbalanced forces.
- Discuss the connection between their findings and these particular situations.

Pulling

One possible way of sharing

Students explain the maximum weight that they could pull and whether the force is balanced or unbalanced.

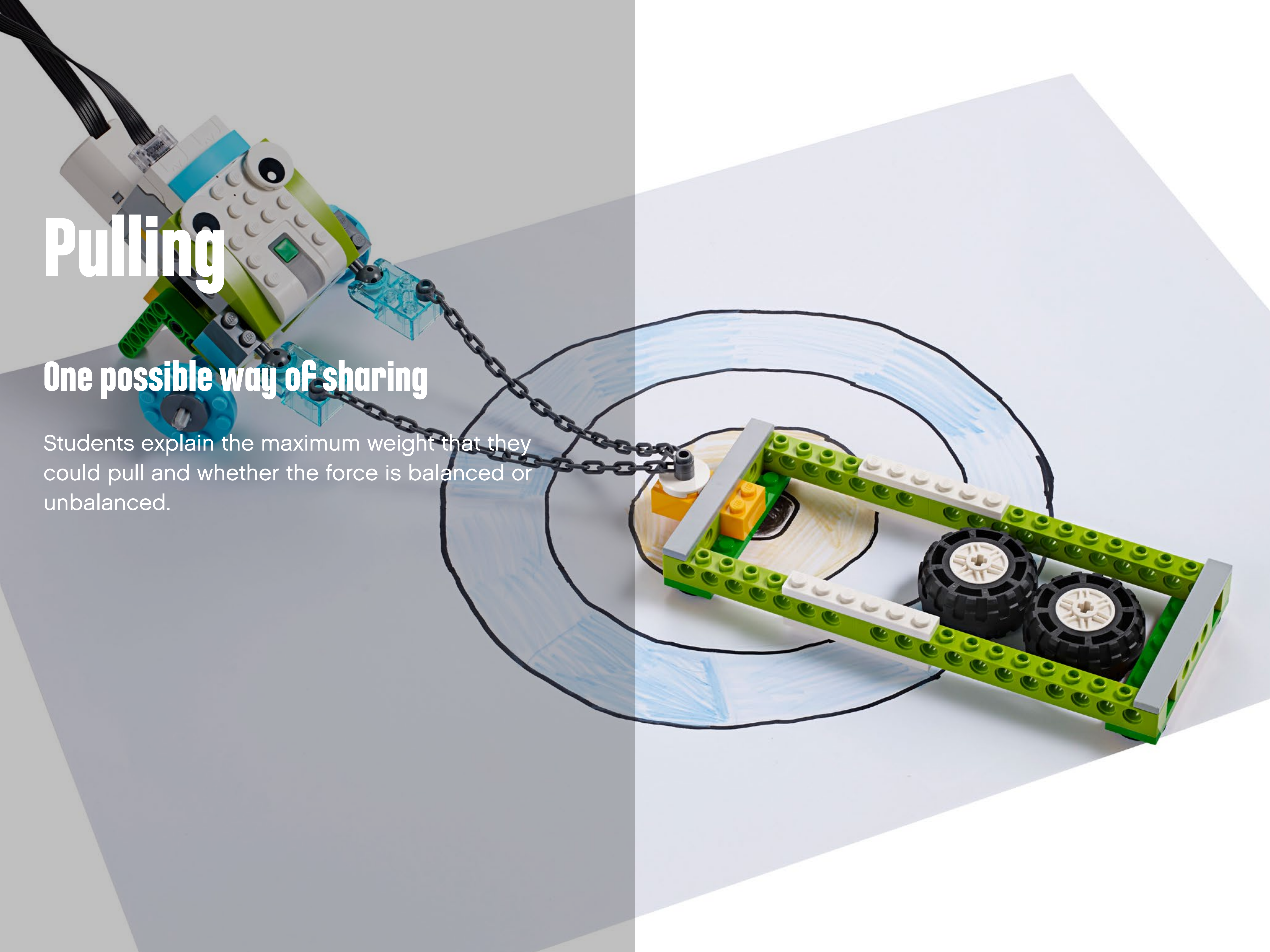

Project 2

Speed

This project is about investigating the factors that make a car go faster and predicting future motion.





Curriculum links

Australian Curriculum: Science

Science Understanding

ACSSU076: Forces can be exerted by one object on another through direct contact or from a distance

Science as a Human Endeavour

ACSHE061: Science involves making predictions and describing patterns and relationships

Science Inquiry Skills

AC SIS064: With guidance, identify questions in familiar contexts that can be investigated scientifically and make predictions based on prior knowledge

AC SIS065: With guidance, plan and conduct scientific investigations to find answers to questions, considering the safe use of appropriate materials and equipment

AC SIS216: Compare results with predictions, suggesting possible reasons for findings

AC SIS069: Reflect on the investigation; including whether a test was fair or not

AC SIS071: Represent and communicate observations, ideas, and findings using formal and informal representations

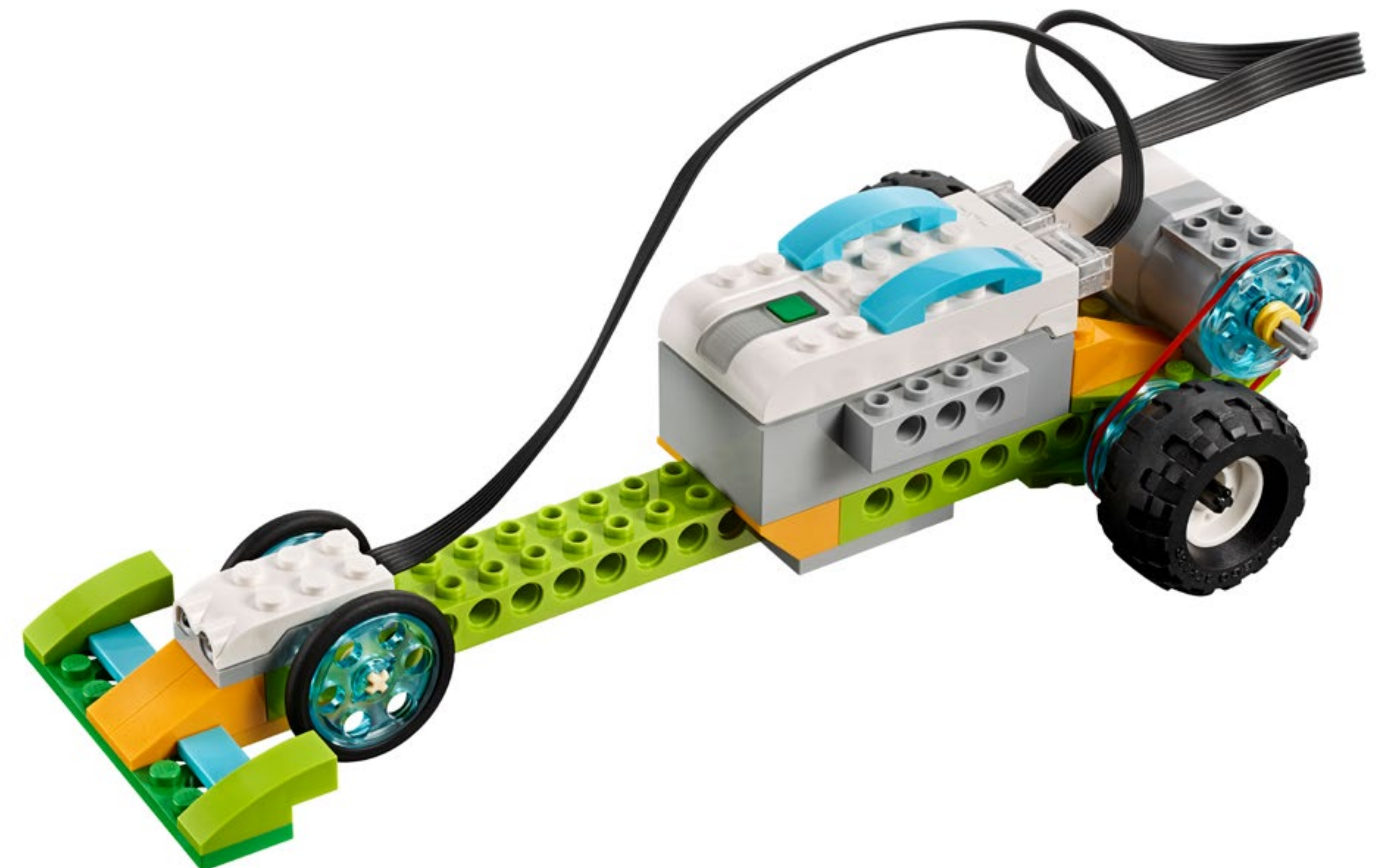



Curriculum links

Other Curriculum links

Australian Curriculum: Technologies Design and Technologies

Knowledge and Understanding

ACTDEK002: Explore how technologies use forces to create movement in products

ACTDEK011: Investigate how forces and the properties of materials affect the behaviour of a product or system

ACTDEK020: Investigate how electrical energy can control movement, sound, or light in a designed product or system

Processes and Production Skills

ACTDEP007: Use materials, components, tools, equipment, and techniques to safely make designed solutions

ACTDEP016: Select and use materials, components, tools, equipment, and techniques, and use safe work practices to make designed solutions

ACTDEP024: Critique needs or opportunities for designing, and investigate materials, components, tools, equipment, and processes to achieve intended designed solutions

Digital Technologies

Knowledge and Understanding

ACTDIK001: Recognise and explore digital systems (hardware and software components) for a purpose

ACTDIK007: Identify and explore a range of digital systems with peripheral devices for different purposes, and transmit different types of data

ACTDIK014: Examine the main components of common digital systems and how they may connect together to form networks to transmit data

Processes and Production Skills

ACTDIP004: Follow, describe, and represent a sequence of steps and decisions (algorithms) needed to solve simple problems

ACTDIP010: Define simple problems, and describe and follow a sequence of steps and decisions (algorithms) needed to solve them

ACTDIP011: Implement simple digital solutions as visual programs with algorithms involving branching (decisions) and user input

ACTDIP019: Design, modify, and follow simple algorithms involving sequences of steps, branching, and iteration (repetition)

ACTDIP020: Implement digital solutions as simple visual programs involving branching, iteration (repetition), and user input



Quick glance: Plan this WeDo 2.0 project

Preparation: 30 min.

- Read the general preparation in the “Classroom Management” chapter.
- Read about the project so you have a good idea of what to do.
- Define how you want to introduce this project: Use the video provided in the project in the WeDo 2.0 Software, or use material of your own choice.
- Determine the end result of this project: the parameters to present and produce the document.
- Make sure that timing allows for expectations to be met.

► Important

This project is an investigation; please refer to the “WeDo 2.0 in Curriculum” chapter for further explanation of investigative practices.

Explore phase: 30-60 min.

- Start the project using the introductory video.
- Hold a group discussion.
- Allow students to document their ideas for Max and Mia’s questions, using the Documentation tool.

Create phase: 45-60 min.

- Ask the students to build the first model from the provided building instructions.
- Ask the students to use a minimum distance of 2m or more. Ask the students to mark a starting point and set up a barrier that will cause the car to stop.
- Allow them to program the model using the sample program.
- Allow time for them to test the different combinations to make the car go faster.

Create more phase (optional): 45-60 min.

- You can use this extension of the project for differentiation or for older students.

Share phase: 45 min. or more

- Make sure your students document the results of each test.
- Ask the students to share their findings based on the information gathered during their investigations.
- Ask them to predict the pattern resulting from doubling the distance.
- Ask the students to create their final presentations.
- Find different ways to let the students share their results.
- Ask the students to present their projects.

► Suggestion

Have a look at the following “Open Projects” when you have completed this project:

- [Space Exploration](#)
- [Moving Materials](#)



Differentiation

To ensure success, consider giving more guidance on building and programming, such as:

- Explain how to conduct an investigation.
- Define the factors your students will focus on, such as the size of the wheels, motor power, or type of pulley setting.

Also, be specific in establishing expectations for students to present and document their findings.

Investigate more

As an added challenge, allow extra time to investigate with student-created designs and programs. This will allow them to explore additional factors that influence speed.

Students' misconceptions

Students often have trouble distinguishing between speed and acceleration. A common misconception held by learners is the idea that if speed is constant, then acceleration is also constant. Speed and acceleration are two different concepts that are linked to each other, but if there is no change in the speed, then there is no acceleration or deceleration.

Vocabulary

Speed

Speed is the measurement of how fast an object moves in relation to a point of reference. Speed is calculated by dividing distance over time.

Acceleration

Measurement of the change of speed



Scientific understanding assessment rubrics

You can use these assessment rubrics with the observation rubrics grid, which you will find in the “Assess with WeDo 2.0” chapter.

Explore phase

During the Explore phase, make sure each student is actively involved in the discussion, asks and answers questions, and can describe factors that affect speed in cars.

1. The student is unable to adequately provide answers to questions, participate in discussions, or describe factors that affect speed.
2. The student is able, with prompting, to adequately provide answers to questions, participate in discussions, or, with help, describe factors that affect speed.
3. The student is able to provide adequate answers to questions, participate in class discussions, or describe the factors that affect speed, though not in detail.
4. The student is able to extend explanations in discussion or describe in detail the factors that affect speed.

Create phase

During the Create phase, make sure each student is able to work as part of a team, test one factor at a time to determine its influence on speed, and use the information collected in the Explore phase.

1. The student is unable to work as part of a team and complete the testing of each factor affecting speed in order to gather information.
2. The student is able to work as part of a team and complete the testing, with help, of each factor affecting speed in order to gather information.
3. The student is able to work as part of a team, contribute to the team discussions, and complete the testing of each factor in order to gather information.
4. The student is able to work as part of a team, serve as the leader, and extend the testing of factors affecting speed beyond the required expectations.

Share phase

During the Share phase, make sure that each student can engage in discussions about the investigation, explain their findings, and use important information from their project to create a final report.

1. The student is unable to engage in discussions about the investigation and use the information to create a final project.
2. The student is able, with prompting, to engage in discussions about the investigation, and use limited information to create a basic final project.
3. The student is able to engage in discussions about the investigation and use the information gathered to produce a final project.
4. The student is able to engage extensively in class discussions about the topic, and use the gathered information to create a final project that includes additional required elements.



Presentation and problem-solving assessment rubrics

You can use these assessment rubrics with the observation rubrics grid, which you will find in the “Assess with WeDo 2.0” chapter.

Explore phase

During the Explore phase, make sure that each student can effectively explain their own ideas and comprehension in relation to the questions posed.

1. The student is unable to share his/her ideas in relation to the questions posed during the Explore phase.
2. The student is able, with prompting, to share his/her ideas related to the questions posed during the Explore phase.
3. The student adequately expresses his/her ideas related to the questions posed during the Explore phase.
4. The student uses details to extend explanations of his/her ideas in relation to the questions posed during the Explore phase.

Create phase

During the Create phase, make sure that each student makes appropriate choices (i.e., screenshot, image, video, text) and follows the established expectations for documenting their findings.

1. The student fails to document findings throughout the investigation.
2. The student gathers documentation of his/her findings, but the documentation is incomplete or does not follow all of the established expectations.
3. The student adequately documents findings for each part of the investigation and makes appropriate choices and selections.
4. The student uses a variety of appropriate methods for documentation and exceeds the established expectations.

Share phase

During the Share phase, make sure that each student uses the evidence that they gathered during their investigations to justify their reasoning, and that they adhere to established guidelines when presenting their findings to an audience.

1. The student does not use evidence from his/her findings when sharing ideas during the presentation. The student does not follow established guidelines.
2. The student uses some evidence from his/her findings, but the justification is limited. In general, established guidelines are followed, but may be lacking in one or more areas.
3. The student adequately provides evidence to justify his/her findings and follows established guidelines for presenting.
4. The student fully discusses his/her findings and thoroughly utilises appropriate evidence to justify his/her reasoning, while following all established guidelines.



Explore phase

The introductory video may set the stage for the following ideas to be reviewed and discussed with students.

Introductory video

Here are some suggested talking points for the video:

1. Cars allow us to move from one point to another, faster. But there was once a time when cars were slower than horses.
2. In a quest for improvement, car engineers searched for elements that could increase the car's speed.
3. Engineers looked at all parts of the car to design stronger engines and mechanisms.
4. Engineers improved the wheels and tyres by changing the size and materials.
5. Today, cars can travel at speeds of up to 400 km/h.





Explore phase

Questions for discussion

Use these questions prior to, and following the lesson.

1. In what ways have cars have been improved to increase their speed?
There are many factors that can influence the speed of a car. The size of the wheels, engine power, gears, aerodynamics, and weight play an important role. The colour of the car, brand, or driver experience should not be considered as potential elements for study.
2. What elements can influence the time required for a car to travel a certain distance as quickly as possible?
This answer should provide prior knowledge regarding comprehension of the content. This means that at the beginning of the lesson, students' answers can be incorrect. However, by the end of the lesson, students should be able to provide an accurate answer to the question.

Additionally, following the lesson, you may want the students to respond to these questions with text or pictures, using the Documentation tool.

Other questions to explore

1. What can you infer about the relationship between wheel size and the time it takes the car to move a set distance?
The larger the wheels, the faster the car will travel, if all other parameters are kept constant.
2. What did you notice about the configuration of the pulley and its effect of the car's speed?
One of the pulley configurations makes the car go faster and the other reduces the speed of the car.
3. How can you measure the speed of an object?
Speed is measured by dividing the time required to travel a distance by the measure of that distance. A unit of speed is always distance divided by time.



Create phase

Build and program a racing car

Students will follow the building instructions to create a racing car. These types of vehicles are optimised to go as fast as possible.

1. Build a racing car.

The drive module used in this project utilises a pulley. This pulley system can be assembled in two different positions: the reduced speed position (small pulley and large pulley), or the normal speed position (large pulley to large pulley).

2. Program the racing car to calculate time.

Students need to have a hand in front of the racing car before the program is started. This program will start by displaying No. 0 and wait for the start signal. When your students remove their hands, the program will turn the motor on, go to maximum power, and repeat, adding No. 1 to the display. The loop will repeat until it reaches the end of the race. The motor will then turn off.

► Important

For this program, students need to put their hands in front of the car before they execute the program string. When they remove their hands, the car will start its race.

► Important

For this investigation, it is crucial that you have the same set up throughout the test. It is the only way students can isolate one element at a time:

- The start line should always be at the same distance from the finish line, this could be a wall or a box.
- The distance between the start and finish line is greater than 2m.





Create phase

Investigate speed factors

With this model, students should be able to test different factors, one at a time. They should test at a distance greater than 2m to see results.

1. Run the race with **SMALL** wheels at motor power 10.

When running this test, students should record the number on the display. They should repeat the test three times to make sure it is consistent.

If the value in one of the three tests is disproportionate, repeat the test for a fourth time. This value is the approximate number of seconds it took for the racing car to travel the distance.

2. Run the race with **BIG** wheels at motor power 10.

By changing the wheels, the racing car should take less time to travel the same distance, and therefore, have a greater speed. Repeating the test three times will make sure it is consistent. If the value of one of the three tests is disproportionate, repeat the test for a fourth time.

Suggestion

Other options could be considered to reach a more precise result, including increasing the number of trials or finding the average result.

3. Predict the time it will take to travel twice the distance.

When the distance is doubled and the motor power level and size of tyres are the same as the previous test, the number of seconds should also double.



Create phase

Use the “Investigate more” section of the student project as an optional extension. Keep in mind that these tasks are an extension of the “Investigate” section and are designed for older or more advanced students.

Investigate more speed factors

With the same racing car model and the same set up, students can hypothesise and test other factors that may influence the speed of the car.

1. Change the motor power.

Changing the motor power level from No.10 to No. 5 will result in the racing car taking more time to travel the same distance.

2. Change the drive mechanism (pulley configuration).

Changing the drive mechanism from the normal position to the reduced speed position will result in the racing car taking more time to travel the same distance.

3. Investigate another element.

Ask the students to carry out the test based on another factor that they think could influence the speed of the racing car. This could be its width, length, height, or weight, or another factor of their own choosing.

Collaboration suggestion

Allow your students ample time to design and build their own ultimate racing car. Encourage them to apply their findings to make them as fast as possible. Then organise a race to see whose car is the fastest.

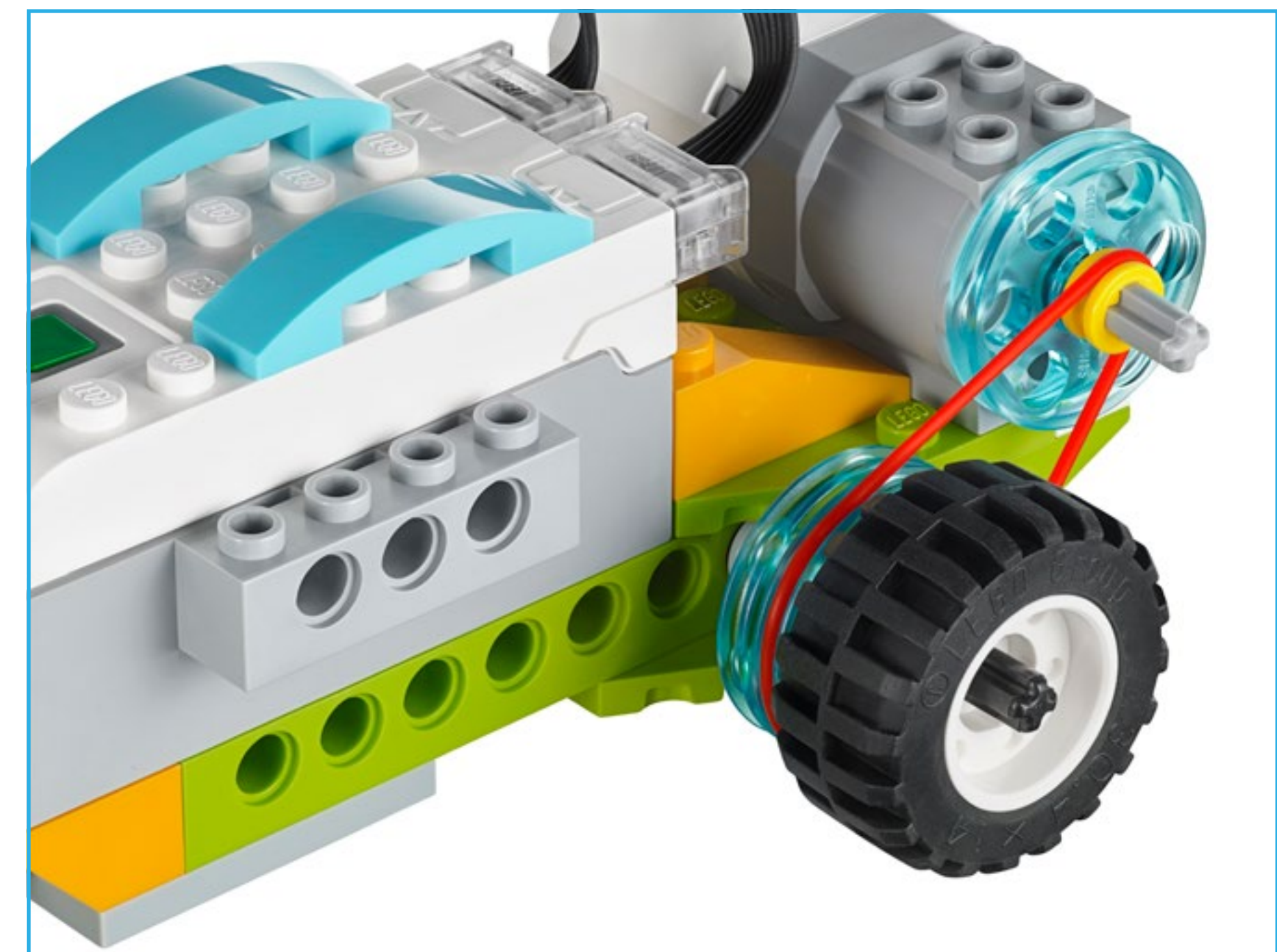
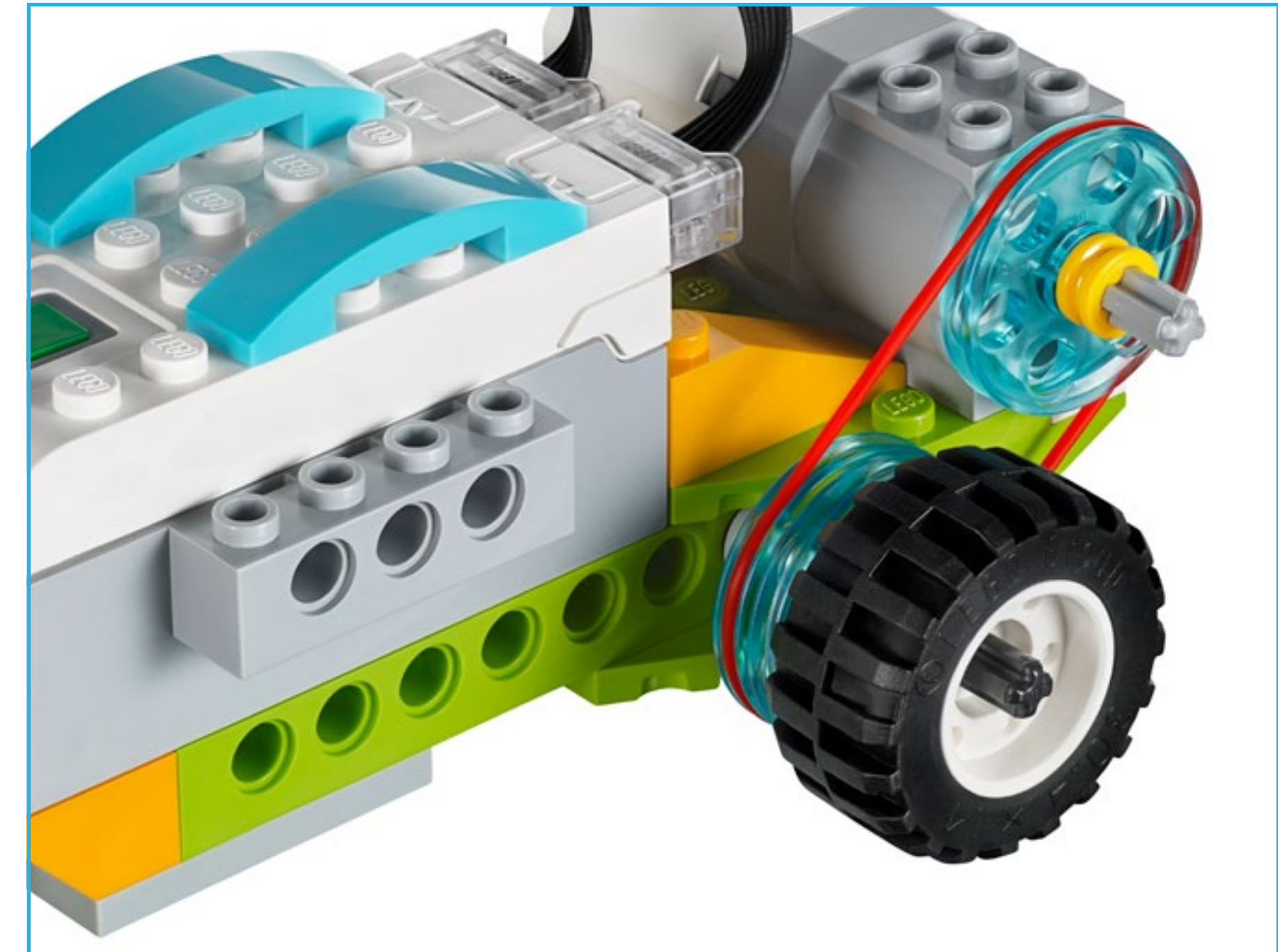



Share phase

Complete the document

Ask the students to document their projects in different ways:

- Ask them to take screenshots of their results.
- Ask them to compare images of their models with real-life images.
- Ask them to record project presentation videos.

Suggestions

Students may collect data in a chart format or on a spreadsheet.

Students may also graph the results of their tests.

Present results

At the end of this project, students should present the elements that influence a car's speed. Conclusions should reflect the fact that larger tyres, stronger motors, and greater motor power, generate higher speeds.

To enhance students' presentations:

- Ask them to put their explanations into context.
- Ask them to analyse real-life situations where they have observed speed as an element.
- Discuss the connection among their findings and these particular situations.

Speed

One possible way of sharing

Students in this class investigate the fastest racing car by organising a race.

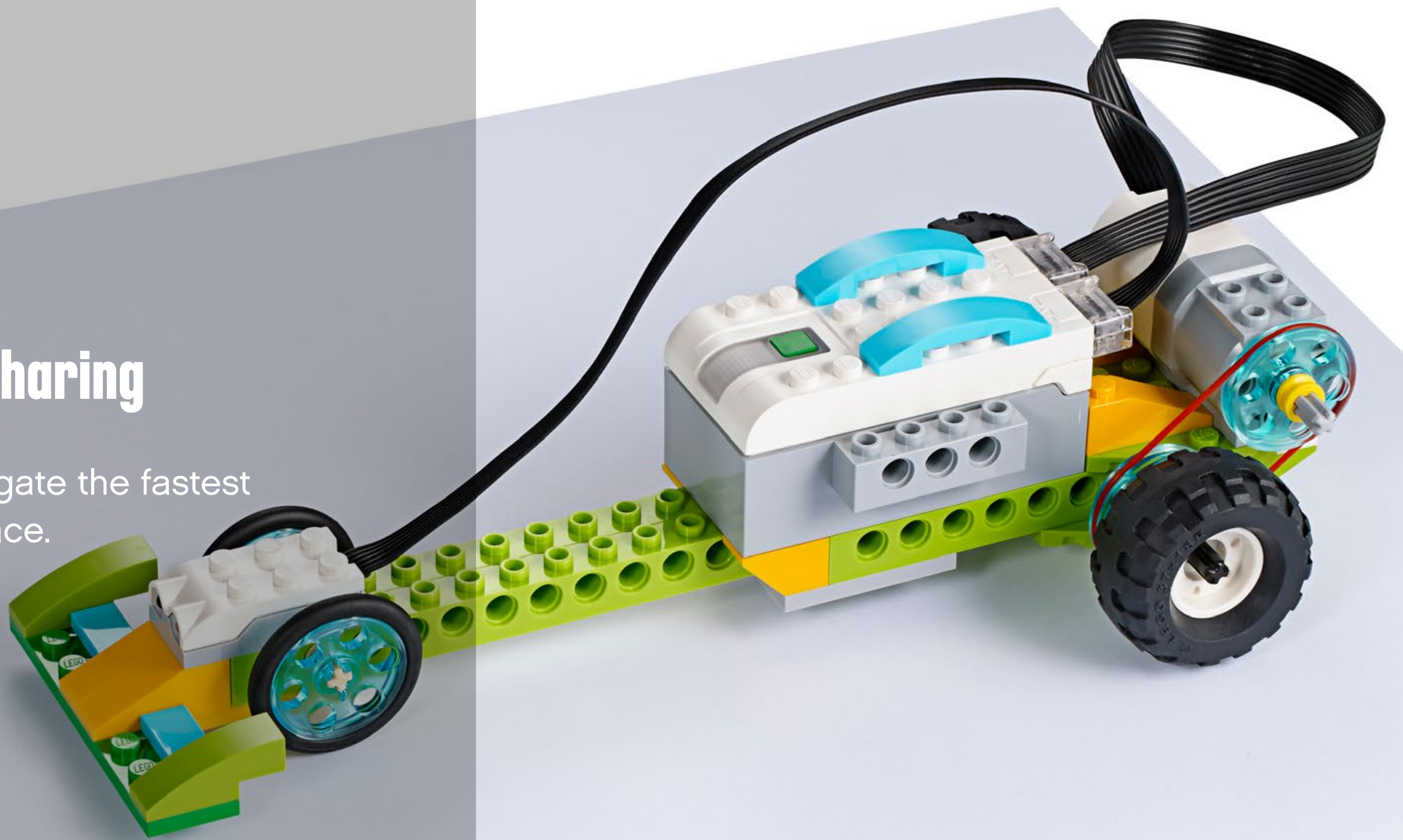

Project 3

Robust Structures

This project is about investigating the characteristics that make a building earthquake resistant, using an earthquake simulator constructed from LEGO® bricks.





Curriculum links

Australian Curriculum: Science

Science Understanding

ACSSU096: Sudden geological changes or extreme weather conditions can affect Earth's surface

Science as a Human Endeavour

ACSHE098: Science involves testing predictions by gathering data and using evidence to develop explanations of events and phenomena, and reflects historical and cultural contributions

ACSHE100: Scientific knowledge is used to solve problems and inform personal and community decisions

Science Inquiry Skills

AC SIS232: With guidance, pose clarifying questions and make predictions about scientific investigations

AC SIS103: Identify, plan, and apply the elements of scientific investigations to answer questions and solve problems using equipment and materials safely and identifying potential risks

AC SIS221: Compare data with predictions and use as evidence in developing explanations

AC SIS108: Reflect on and suggest improvements to scientific investigations

AC SIS110: Communicate ideas, explanations, and processes using scientific representations in a variety of ways, including multi-modal texts

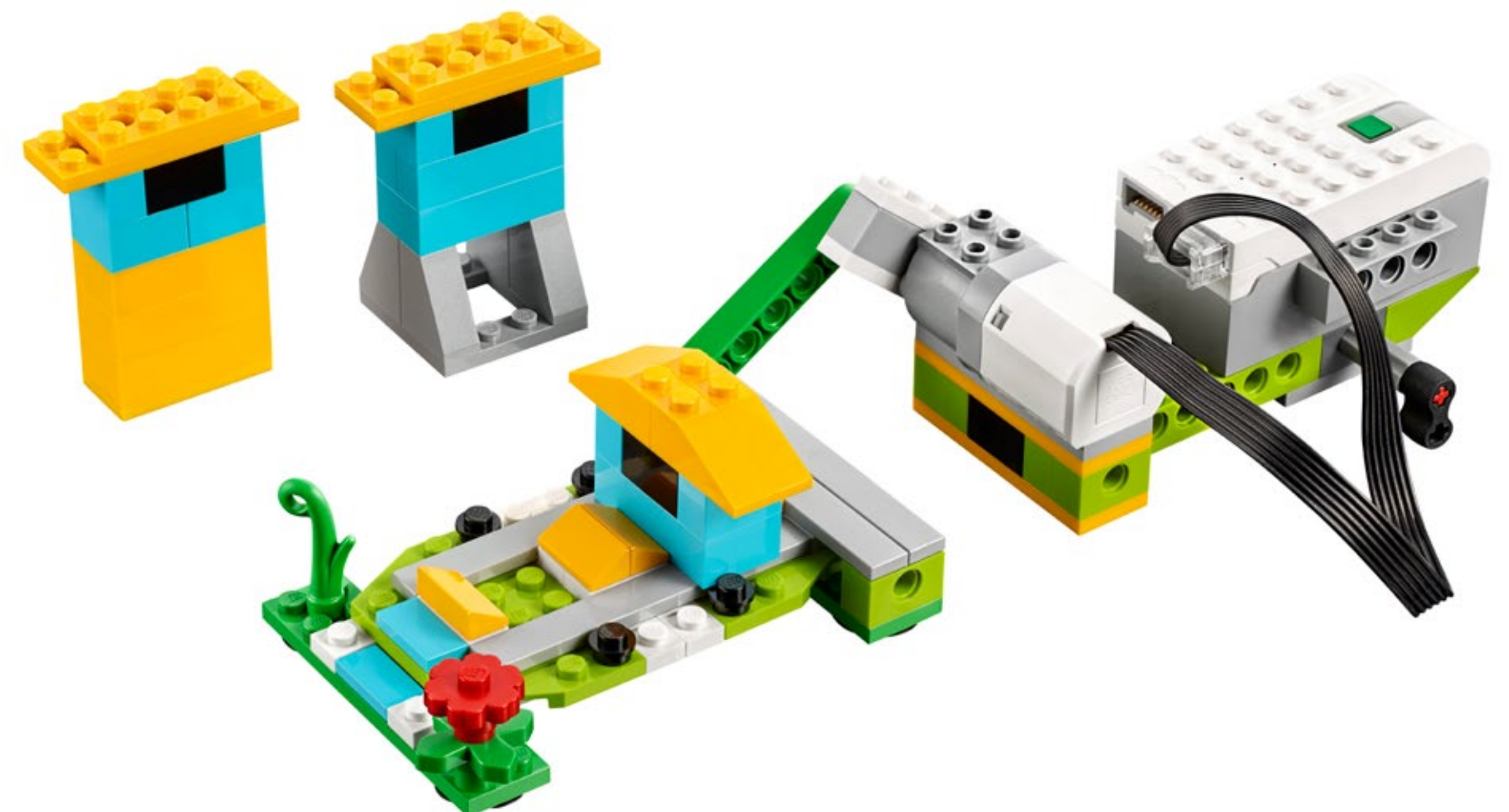



Curriculum links

Other Curriculum links

Australian Curriculum: Technologies Design and Technologies

Knowledge and Understanding

ACTDEK010: Recognise the role of people in design and technologies occupations and explore factors, including sustainability that impact on the design of products, services and environments to meet community needs

ACTDEK011: Investigate how forces and the properties of materials affect the behaviour of a product or system

Processes and Production Skills

ACTDEP016: Select and use materials, components, tools, equipment and techniques and use safe work practices to make designed solutions

ACTDEP017: Evaluate design ideas, processes and solutions based on criteria for success developed with guidance and including care for the environment

Digital Technologies

Knowledge and Understanding

ACTDIK001: Recognise and explore digital systems (hardware and software components) for a purpose

ACTDIK007: Identify and explore a range of digital systems with peripheral devices for different purposes, and transmit different types of data

ACTDIK014: Examine the main components of common digital systems and how they may connect together to form networks to transmit data

Processes and Production Skills

ACTDIP004: Follow, describe, and represent a sequence of steps and decisions (algorithms) needed to solve simple problems

ACTDIP011: Implement simple digital solutions as visual programs with algorithms involving branching (decisions) and user input

ACTDIP019: Design, modify, and follow simple algorithms involving sequences of steps, branching, and iteration (repetition)

ACTDIP020: Implement digital solutions as simple visual programs involving branching, iteration (repetition), and user input



Quick glance: Plan this WeDo 2.0 project

Preparation: 30 min.

- For information regarding general preparation, please see the “Classroom Management” chapter.
- Read about the project so you have a good idea of what to do.
- Define how you want to introduce this project: Use the video provided in the WeDo 2.0 Software, or use material of your own choice.
- Determine the end result of this project: the parameters to present and produce the document.
- Make sure timing allows for expectations to be met.

► Important

This project is an investigation; please refer to the “WeDo 2.0 in Curriculum” chapter for further explanation of investigative practices.

Explore phase: 30-60 min.

- Start the project using the introductory video.
- Hold a group discussion.
- Allow students to document their ideas for Max and Mia’s questions, using the Documentation tool.

Create phase: 45-60 min.

- Ask the students to build the earthquake simulator and three buildings using the provided building instructions.
- Allow them to program the model using the sample program.
- Allow time so that students understand how the program works, and give them time to modify the parameters and carry out further tests.

Create more phase (optional): 45-60 min.

- You can use this extension of the project for differentiation or for older students.

Share phase: 45 min. or more

- Make sure your students document their work as they test different structures.
- Allow the students to share their experiences in different ways.
- Ask the students to create their final reports and present their projects.

► Suggestion

Have a look at the following “Open Projects” when you have completed this project:

- [Hazard Alarm](#)
- [Moving Materials](#)



Differentiation

To ensure success, consider giving more guidance on building and programming, such as:

- Explain how to conduct an investigation.
- Utilise evidence to construct explanations.
- Offer them additional experiences with isolated variables to test hypotheses.

Also, be specific in establishing expectations for students to present and document their findings.

▶ Suggestion

For more experienced students, allow extra time for building and programming so they can use their own inquiries to design their own investigations. Students could change parameters, such as the level of the earthquake simulator, the materials used to construct the buildings, or the surface on which they test their buildings.

Investigate more

Students will design the tallest building, resisting a grade 8 earthquake. They will apply learnings from the previous investigation.

Possible student misconceptions

Students may believe that earthquakes happen in random locations across the earth. Most of the world's seismic activity is associated with tectonic plate boundaries. While shallow crevasses may form during an earthquake, due to landslides or ground failures, the ground does not “open up” along a fault line.

Vocabulary

Earthquake

Ground vibrations produced when earth's tectonic plates slip past each other

Tectonic plates

Large parts of the earth's crust that move relative to each other due to convection currents in the underlying mantle

Richter scale

Logarithmic scale that classifies the level of the energy released during an earthquake

Variable

In a scientific experiment, an element that can be manipulated, controlled, or measured

Prototype

Early sample or model that is used to test a concept



Scientific understanding assessment rubrics

You can use these assessment rubrics with the observation rubrics grid, which you will find in the “Assess with WeDo 2.0” chapter.

Explore phase

During the Explore phase, make sure each student is actively involved in the discussion, asks and answers questions, and can answer questions about earthquakes in their own words.

1. The student is unable to provide answers to questions or participate in discussions adequately.
2. The student is able, with prompting, to provide answers to questions, participate in discussions, or describe elements that may influence a structure's resistance to earthquakes.
3. The student is able to provide adequate answers to questions, participate in class discussions, and describe elements that may influence a structure's resistance to an earthquake.
4. The student is able to extend the explanations in discussion and describe in detail the factors that may influence a structure's resistance to an earthquake.

Create phase

During the Create phase, make sure that the students use documentation to record predictions and findings, and change only one variable at a time when conducting investigations.

1. The student does not complete the necessary documentation during the investigations and rarely exhibits accuracy in changing only one variable at a time.
2. The student documents his/her findings, but some critical elements are missing, and the student is inconsistent in changing only one variable at a time during the investigations.

3. The student uses adequate documentation to record predictions and findings, or generally exhibits accuracy in changing only one variable at a time during the investigations.
4. The student uses excellent documentation to record predictions and findings or consistently exhibits accuracy in changing only one variable at a time during the investigations.

Share phase

During the Share phase, make sure that each student can effectively utilise documents and verbal communication to explain what is happening with the earthquake simulator, and what can be concluded from the results of the tests.

1. The student offers no explanation, neither in his/her document nor through verbal communication.
2. The student ineffectively utilises documents and verbal communication to explain what is happening and what can be concluded. The explanation may be incomplete or inaccurate.
3. The student ineffectively utilises documents and verbal communication to explain what is happening and what can be concluded.
4. The student effectively utilises documents and verbal communication to offer a sophisticated and accurate explanation of what is happening and what can be concluded.



Presentation and problem-solving assessment rubrics

You can use these assessment rubrics with the observation rubrics grid, which you will find in the “Assess with WeDo 2.0” chapter.

Explore phase

During the Explore phase, make sure that each student can effectively explain their own ideas and comprehension related to the questions posed.

1. The student is unable to share his/her ideas related to the questions posed during the Explore phase.
2. The student is able, with prompting, to share his/her ideas related to the questions posed during the Explore phase.
3. The student adequately expresses his/her ideas related to the questions posed during the Explore phase.
4. The student uses details to extend explanations of his/her ideas related to the questions posed during the Explore phase.

Create phase

During the Create phase, make sure that each student makes appropriate choices (i.e., screenshot, image, video, text) and follows the established expectations for documenting their findings.

1. The student fails to document findings throughout the investigation.
2. The student gathers documentation of his/her findings, but the documentation is incomplete or does not follow all of the established expectations.
3. The student adequately documents findings for each part of the investigation and makes appropriate choices and selections.
4. The student uses a variety of appropriate methods for documentation and exceeds the established expectations.

Share phase

During the Share phase, make sure that each student uses evidence from their own document text and video to explain ideas, including what happened and why.

1. The student does not use evidence from his/her own document text and video and cannot explain ideas, including what happened and why.
2. The student uses some evidence from his/her own document text and video but cannot completely explain ideas, including what happened and why.
3. The student uses evidence from his/her own document text and video to explain ideas, including what happened and why.
4. The student uses a variety of evidence from his/her own document text and video to thoroughly explain ideas, including what happened and why.



Explore phase

The introductory video may set the stage for the following ideas to be reviewed and discussed with students.

Introductory video

Here are some suggested talking points for the video:

1. Since it was formed, the earth has been changing shape. Like pieces of biscuit being pushed around on top of a layer of honey, the tectonic plates that compose the earth slide, rub together, and collide.
2. When doing so, the friction creates vibrations on the surface of the earth.
3. During an earthquake, depending on the strength of the vibrations and a variety of other factors, buildings and other structures may be damaged or destroyed.
4. Today buildings are more resistant to earthquakes, thanks to recent scientific discoveries that have led to improvements in design.

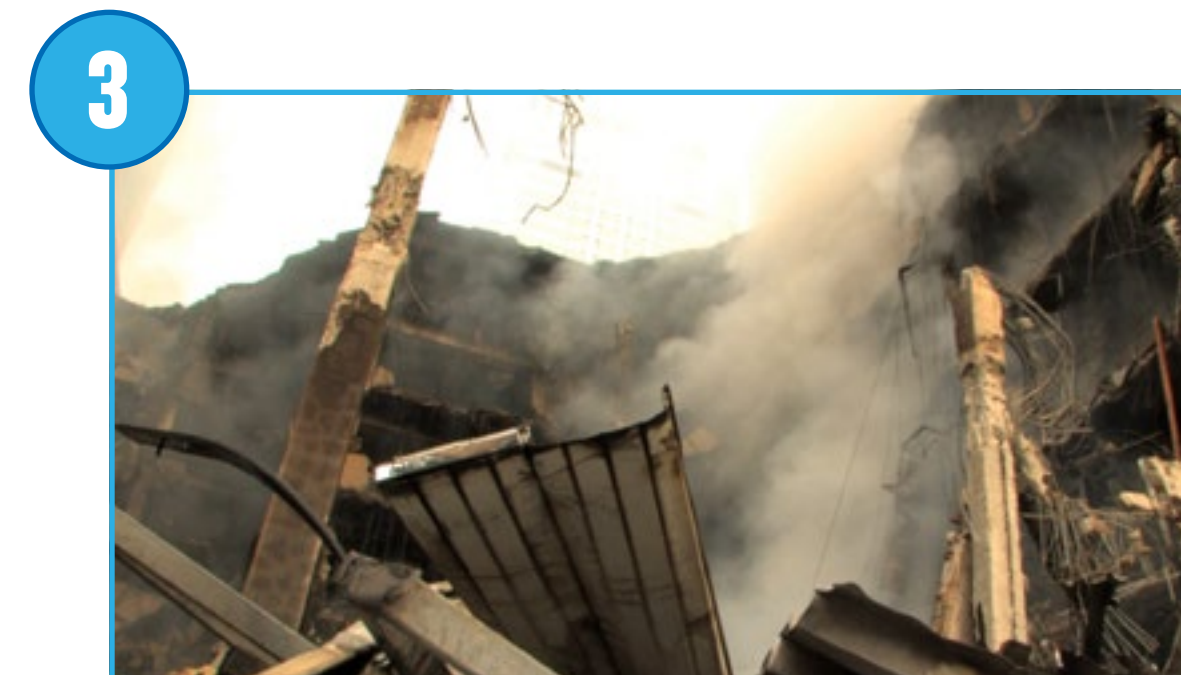
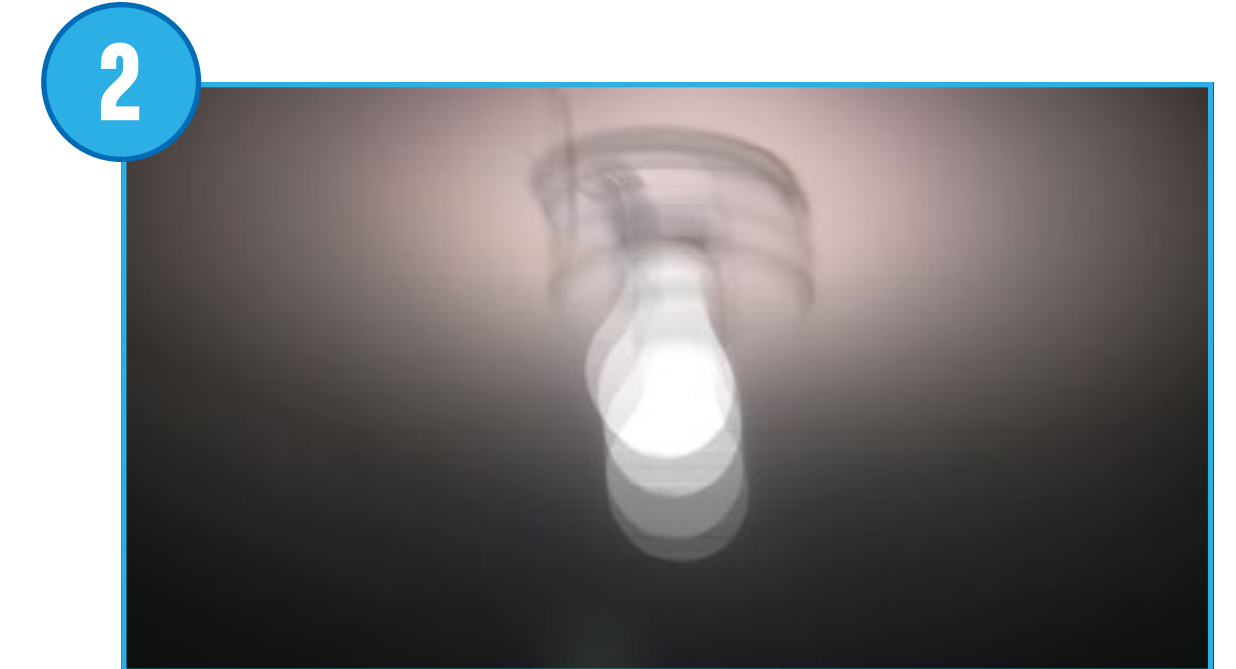
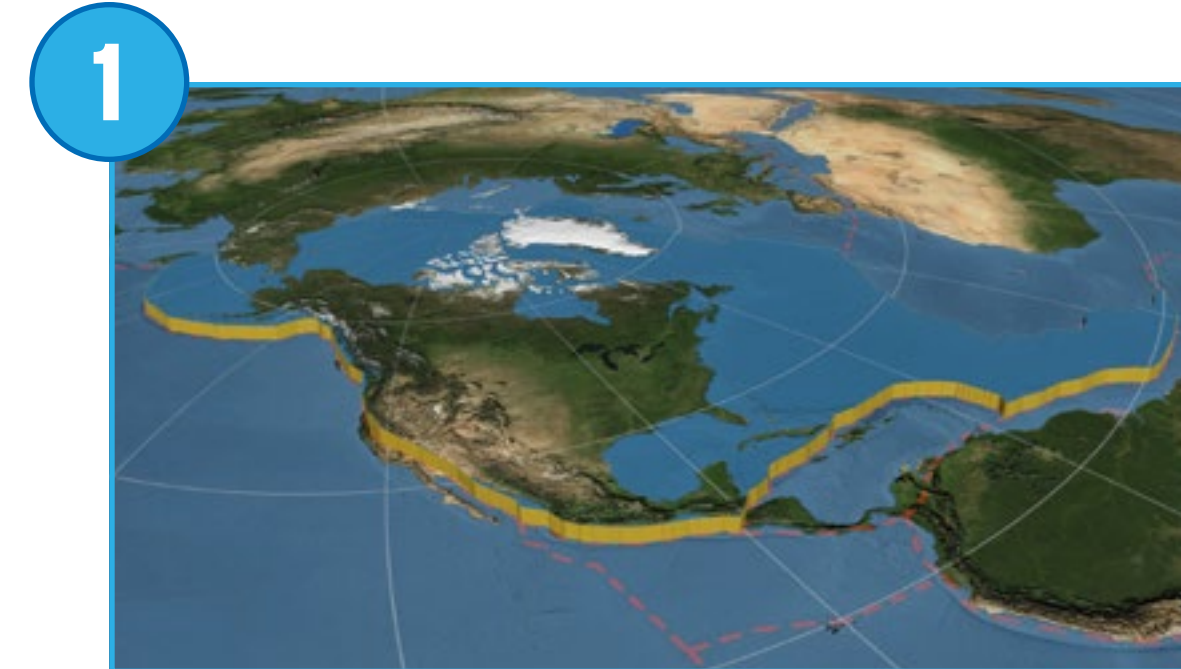



Explore phase

Questions for discussion

During the Explore phase, these questions are intended to elicit students' initial ideas and/or summarise prior learning to evaluate the performance expectation for this project.

Ask the students to document their comprehension, and refer back to these questions again during and after the Create phase.

1. What causes earthquakes and what are the hazards they create?

Earthquakes are vibrations of the earth's crust caused by the movement of the tectonic plates.

2. How do scientists rate the strength of an earthquake?

Scientists rate earthquakes on a scale they call the Richter scale. The higher the number, on a scale of 1 to 10, the stronger the earthquake.

3. What elements can influence the resistance of buildings during earthquakes?

This answer should serve as the students' hypothesis. This means that at this point, your students' answer may be incorrect.

Ask your students to answer with text or pictures using the Documentation tool.

Other questions to explore

1. What did you notice about the relationship between the size of a building's footprint and height, and its ability to withstand the impact of an earthquake?

Structures that are tall or slim are generally less stable and are more likely to fall when submitted to lateral forces.

2. How did you ensure that the tests were kept fair?

Changing only one parameter at a time.

3. What other factors would be important to investigate?

Structural design and materials also have to be considered when testing a building's resistance to earthquakes.

4. How are modern buildings designed to withstand earthquakes?

Architects and engineers use structures, principles, and simulations to test prototypes for weaknesses.

5. Does "resistant" mean the same thing as "strong"?

It depends on a variety of factors. Sometimes flexible structures or materials are more resistant than rigid or strong structures.



Create phase

Build and program an earthquake simulator and model buildings

Students will follow the building instructions to create an earthquake simulator. With this device, they will gather evidence to decide which building would pass the earthquake test.

1. Build an earthquake simulator.

The shake model used in this project uses a piston to push and pull the test plate. The motor power level of the program determines the amplitude of the generated earthquake.

2. Program the simulator.

This program will start by displaying No. 0 on the screen. It will then repeat a series of actions, five times. It will add No. 1 to the display, representing the shake magnitude, turn the motor on to that magnitude for two seconds, and then wait for one second.

► Important

With this program, if students want to test a stronger or weaker earthquake, they will need to change the number of loops. Allow them to use a program of their own.





Create phase

Investigate your building design

Now that students understand the way the earthquake simulator works, let them investigate different factors by isolating one variable at a time.

1. Change the height.

Students should use the short and the tall buildings, both with narrow bases (buildings A and B).

With the tall building on the shaking base, students should find the minimum magnitude that causes the structure to fall. Then, with that same program, they should test if the narrow or short building is more resistant.

Students should be able to discover that with the same base area, the short building is more resistant than the tall building.

► Important

Because not all of the motors react exactly the same, it is possible that magnitudes vary, giving different results for each team.

2. Change the width of the base.

With the same program, ask the students to test if the tall building with the narrow base (building B) can resist better than the narrow, tall building with the wide base (building C).

Students should be able to discover that with a larger base area, a tall building is more resistant.

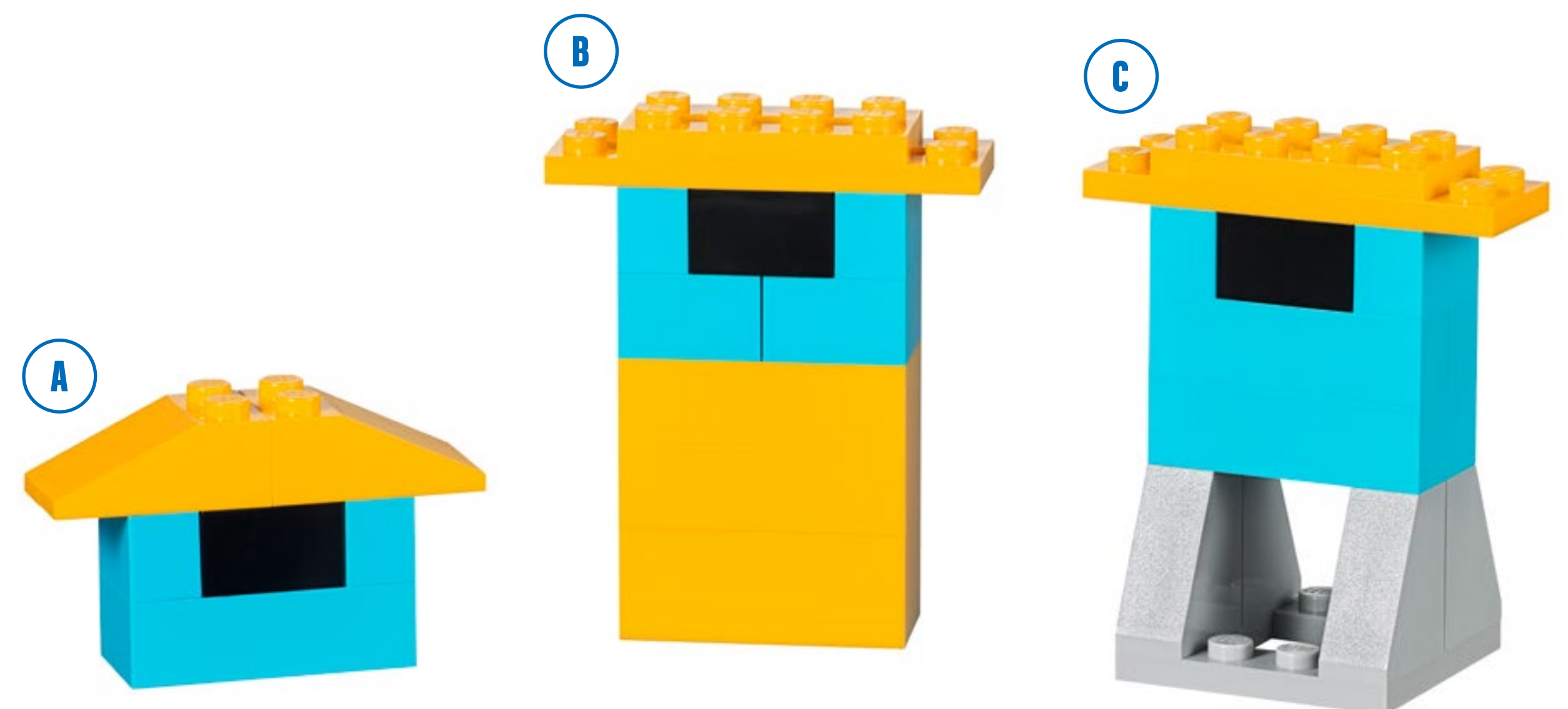



Create phase

Use the “Investigate more” section of the student project as an optional extension. Keep in mind that these tasks are an extension of the “Investigate” section and are designed for older or more advanced students.

Investigate more with the earthquake simulator

Ask your students to explore other elements that affect the buildings’ resistance to vibration.

1. Change the magnitude.

Ask the students to predict what would happen to buildings A, B, and C if the magnitude of the earthquake was increased, for example, up to level 8.

Ask them to record their predictions and test each case.

2. Change buildings.

Applying the fact that a larger base will enable a building to withstand stronger vibrations, challenge your students to build the tallest possible, level-8 earthquake resistant, structure.

Ask the students to explore different building compositions:

- Explore different structural shapes.
- Introduce new materials.

Collaboration suggestion

Allow teams to compare their building designs. Ask one team to describe and test the work of another team:

- What are the structure’s strengths?
- What are the structure’s weaknesses?
- Will the building withstand the earthquake test?



Share phase

Complete the document

Ask the students to document their projects in different ways:

- Ask the students to take a video of each test they conduct in order to prove their claims.
- Ask your students to compare these conclusions with real-life cases.

Suggestions

Students may collect data in a chart format or on a spreadsheet.

Students may also graph the results of their tests.

Present results

At the end of this project, students should present the results of their investigations.

To enhance your students' presentation:

- Ask them to describe the factors that influence a building's stability.
- Ask them to compare these thoughts with their findings.
- Ask them to put their explanations into context.
- Ask them to reflect on their conclusions.
- Discuss whether their results reflect reality.

Robust Structures

One possible way of sharing

Students in this class are testing the tallest building. They hope it will resist a level 10 earthquake.

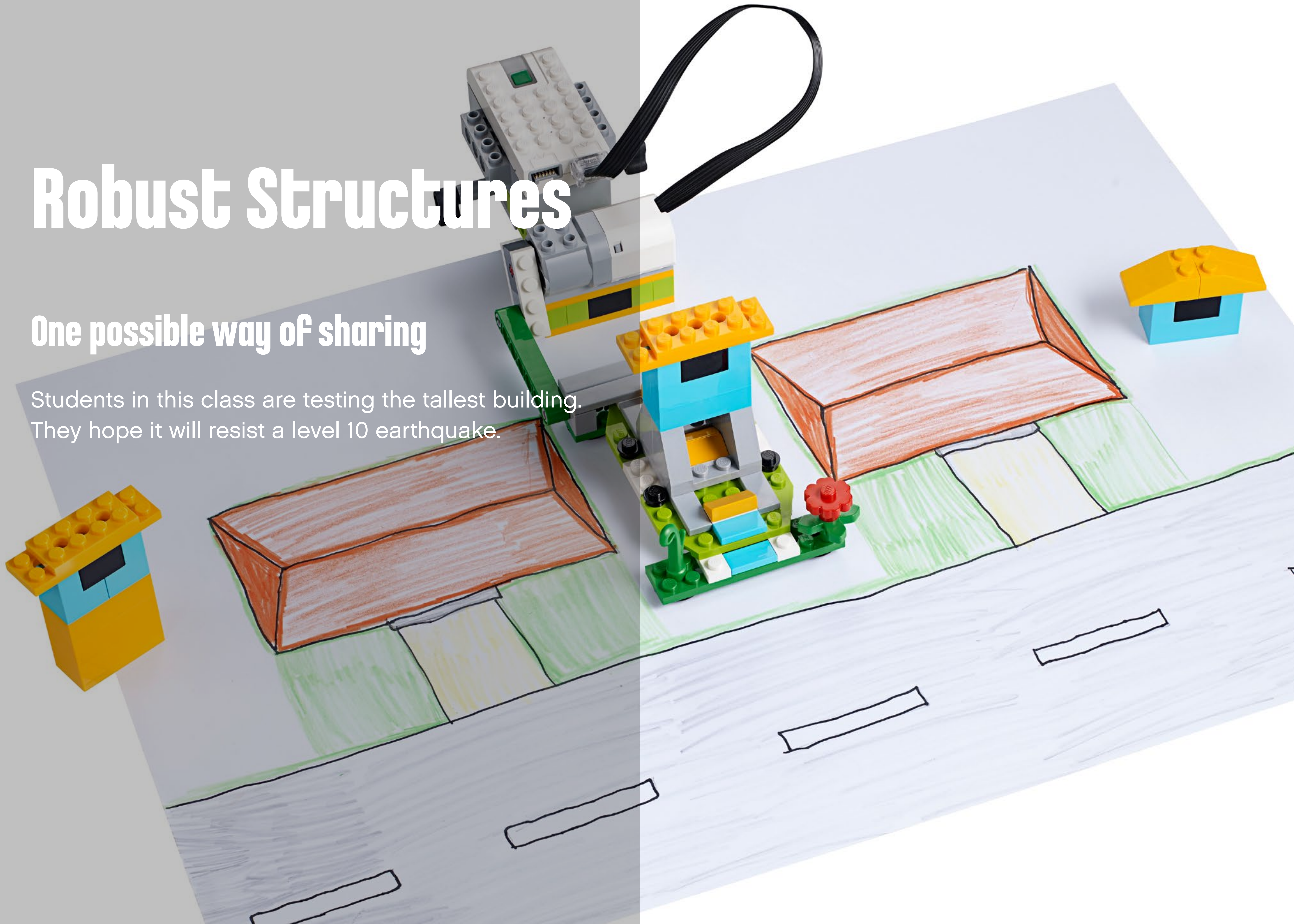

Project 4

Frog's Metamorphosis

This project is about modelling a frog's metamorphosis using a LEGO® representation and identifying the characteristics of the organism at each stage.





Curriculum links

Australian Curriculum: Science

Science Understanding

ACSSU030: Living things grow, change, and have offspring similar to themselves

ACSSU044: Living things can be grouped on the basis of observable features and can be distinguished from non-living things

ACSSU072: Living things have life cycles

Science as a Human Endeavour

ACSHE034: Science involves asking questions about, and describing changes in, objects and events

ACSHE050: Science involves making predictions and describing patterns and relationships

ACSHE061: Science involves making predictions and describing patterns and relationships

Science Inquiry Skills

AC SIS053: With guidance, identify questions in familiar contexts that can be investigated scientifically and make predictions based on prior knowledge

AC SIS215: Compare results with predictions, suggesting possible reasons for findings

AC SIS216: Compare results with predictions, suggesting possible reasons for findings

AC SIS041: Compare observations with those of others

AC SIS058: Reflect on the investigation, including whether a test was fair or not

AC SIS069: Reflect on the investigation; including whether a test was fair or not

AC SIS042: Represent and communicate observations and ideas in a variety of ways

AC SIS060: Represent and communicate observations, ideas, and findings using formal and informal representations

AC SIS071: Represent and communicate observations, ideas, and findings using formal and informal representations





Curriculum links

Other Curriculum links

Australian Curriculum: Technologies Design and Technologies

Knowledge and Understanding

ACTDEK002: Explore how technologies use forces to create movement in products

Processes and Production Skills

ACTDEP007: Use materials, components, tools, equipment, and techniques to safely make designed solutions

Digital Technologies

Knowledge and Understanding

ACTDIK001: Recognise and explore digital systems (hardware and software components) for a purpose

ACTDIK007: Identify and explore a range of digital systems with peripheral devices for different purposes, and transmit different types of data

ACTDIK014: Examine the main components of common digital systems and how they may connect together to form networks to transmit data

Processes and Production Skills

ACTDIP004: Follow, describe, and represent a sequence of steps and decisions (algorithms) needed to solve simple problems

ACTDIP010: Define simple problems, and describe and follow a sequence of steps and decisions (algorithms) needed to solve them

ACTDIP011: Implement simple digital solutions as visual programs with algorithms involving branching (decisions) and user input

ACTDIP019: Design, modify, and follow simple algorithms involving sequences of steps, branching, and iteration (repetition)

ACTDIP020: Implement digital solutions as simple visual programs involving branching, iteration (repetition), and user input



Quick glance: Plan this WeDo 2.0 project

Preparation: 30 min.

- Read the general preparation in the “Classroom Management” chapter.
- Read about the project so you have a good idea of what to do.
- Define how you want to introduce this project: Use the video provided in the WeDo 2.0 Software, or use material of your own choice.
- Determine the end result of this project: the parameters to present and produce the document.
- Make sure that timing allows for expectations to be met.

► Important

This project uses models to represent a real-world concept. Please refer to the “WeDo 2.0 in Curriculum” chapter for further explanations of modelling practices. It introduces a frog's life as one representation of a life cycle. This project is intended to be an application of students' prior knowledge regarding life cycles of plants and animals. It could be used as an assessment itself.

Explore phase: 30-60 min.

- Start the project using the introductory video.
- Hold a group discussion.
- Allow students to document their ideas for Max and Mia's questions using the Documentation tool.

Create phase: 45-60 min.

- Ask the students to build the first model from the provided building instructions.
- Allow them to program the model using the sample program.
- Allow time, so that they can make the young frog evolve into an adult frog. In this step, guide them in building their frog according to what you have discussed in the Explore phase.

Create more phase (optional): 45-60 min.

- You can use this extension of the project for differentiation or for older students.

Share phase: 45 min. or more

- Make sure your students document the changes in their frogs and explain how they have modified their models to reflect the various stages of a frog's metamorphosis.
- Allow the students to share their experiences in different ways.
- Ask the students to create their final science report.
- Ask the students to present their projects.

► Suggestion

Have a look at the following “Open Projects” when you have completed this project:

- Predator and Prey
- Extreme Habitats



Differentiation

To ensure success, consider giving more guidance on building and programming, such as:

- How to make back legs longer or how to create front legs
- How to change its appearance by changing its eyes
- Use the Motion Sensor to detect predators and escape

Be specific about how you would like them to present and document their findings. For example, a team sharing session.

Suggestion

For more experienced students, you may want to allow them extra time for building and programming to allow them to create models of different animals. Then also ask them to compare and contrast the different animal life cycle models.

You could also revisit the model of the tadpole and determine a way to construct a functional tail. Review the turn base module in the Design Library to get help.

Use the model further

To use the model further, ask your students to study external factors that can influence the life cycle of the frog and their effects on the frog's body. Examples could include: pollution effects, predator elimination, and population changes.

Students' misconceptions

Students might think metamorphosis occurs for all animals. Certain animals have very similar life cycles, and some have very different ones. For example, mammals and insects have very different life cycles, but a horse and a cat are both similar because they are mammals. Explore the following terms while defining a life cycle.

Vocabulary

Life cycle

Important changes in an organism's form that take place in specific stages

Metamorphosis

Extreme physical transformation of an organism, which is usually accompanied by a change of habitat or behaviour

Incomplete metamorphosis

An animal that only goes through three stages in the life cycle, for example, the dragonfly

Complete metamorphosis

An animal that completes four stages in the life cycle, for example, the butterfly or frog

Larva

The juvenile form of an animal that goes through metamorphosis (with frogs, a tadpole is the larval stage)



Scientific understanding assessment rubrics

You can use these assessment rubrics with the observation rubrics grid, which you will find in the “Assess with WeDo 2.0” chapter.

Explore phase

During the Explore phase, make sure that each student is actively involved in the discussion, asks and answers questions, and documents and offers responses to questions, such as “What are the different stages of a frog’s life?”, in his/her own words.

1. The student is not involved in the discussion of the questions posed during the Explore phase, and no documentation is captured.
2. The student contributes little to the discussion of the questions posed during the Explore phase and documents some of his/her responses.
3. The student contributes sufficiently to the discussion of the questions posed during the Explore phase and adequately documents his/her responses.
4. The student actively contributes to the discussion of the questions posed during the Explore phase and documents his/her responses.

Create phase

During the Create phase, make sure that each student actively investigates solutions by planning, designing, and redesigning, if necessary, and can apply his/her understanding of the life cycle of a frog when representing it in a model.

1. The student neglects to create a model to represent the frog life cycle that demonstrates evidence of comprehension.
2. The student creates a model to represent the frog life cycle that demonstrates some evidence of comprehension.
3. The student successfully creates a model to represent the frog life cycle that demonstrates adequate evidence of comprehension.
4. The student creates a model to represent the frog life cycle that demonstrates evidence of a highly developed comprehension.

Share phase

During the Share phase, make sure that each student can explain the life cycle of the frog and the changes it undergoes; identify limitations of their model (what is close to reality and what is not); and use important information from his/her project to create the final report.

1. The student neglects to discuss the limitations of the model or the life cycle of a frog. The student does not use the information to create the final report.
2. The student is able to discuss, with prompting, some of the limitations of the model and the life cycle of a frog. The student uses some information to create the final report.
3. The student is able to adequately discuss the limitations of the model and the life cycle of a frog and use all necessary information to create the final report.
4. The student discusses the limitations of the model and the life cycle of a frog and uses all necessary information to create the final report.



Presentation and problem-solving assessment rubrics

You can use these assessment rubrics with the observation rubrics grid, which you will find in the “Assess with WeDo 2.0” chapter.

Explore phase

During the Explore phase, make sure that each student can effectively explain their own ideas through collaboration with peers and comprehension related to the questions posed.

1. The student does not share his/her ideas related to the questions posed during the Explore phase and shows no evidence of collaboration with peers.
2. The student is able, with prompting, to share his/her ideas through collaboration with peers during the Explore phase.
3. The student adequately shares his/her ideas through collaboration with peers during the Explore phase.
4. The student uses details to share insightful ideas through collaboration with peers during the Explore phase.

Create phase

During the Create phase, make sure that each student uses precise language and appropriate vocabulary, and makes appropriate choices in communicating concepts using the Documentation tool.

1. The student does not use precise language or vocabulary appropriately and does not demonstrate thoughtful choices in communicating concepts with the Documentation tool.
2. With prompting, the student can incorporate some appropriate vocabulary and generally makes appropriate choices in communicating concepts using the Documentation tool.
3. The student uses precise language and appropriate vocabulary and makes appropriate choices in communicating concepts using the Documentation tool.

4. The student uses precise language and advanced vocabulary and makes appropriate choices in communicating concepts using the Documentation tool.

Share phase

During the Share phase, make sure that each student describes the relationship between the model and scientific concepts related to the life cycle of a frog, using appropriate vocabulary.

1. The student does not effectively describe the relationship between the model and any scientific concepts related to the life cycle of a frog.
2. The student describes the relationship between the model and scientific concepts related to the life cycle of a frog, but there are inaccuracies and relevant pieces of information are missing.
3. The student adequately describes the relationship between the model and scientific concepts related to the life cycle of a frog using appropriate vocabulary.
4. The student describes, in detail, the relationship between the model and scientific concepts related to the life cycle of a frog using advanced vocabulary.



Explore phase

The introductory video may set the stage for the following ideas to be reviewed and discussed with students.

Introductory video

Unlike mammals, frogs go through metamorphosis:

1. Frogs start their lives as eggs. Not all baby frogs survive, many are eaten by predators.
2. When the eggs hatch, the tadpoles start looking for sources of food.
3. Tadpoles slowly grow legs as they become young frogs (froglets).
4. For many species, after about twelve weeks, the frog has its adult shape and can jump, eat flies, and reproduce.

Although this varies among frog species, the metamorphosis of a typical frog from birth to adult takes an average of sixteen weeks. Once a frog has reached adulthood, it can reproduce. There are species of frog that have a life span of less than two years, while other species may live up to fifteen years or more.

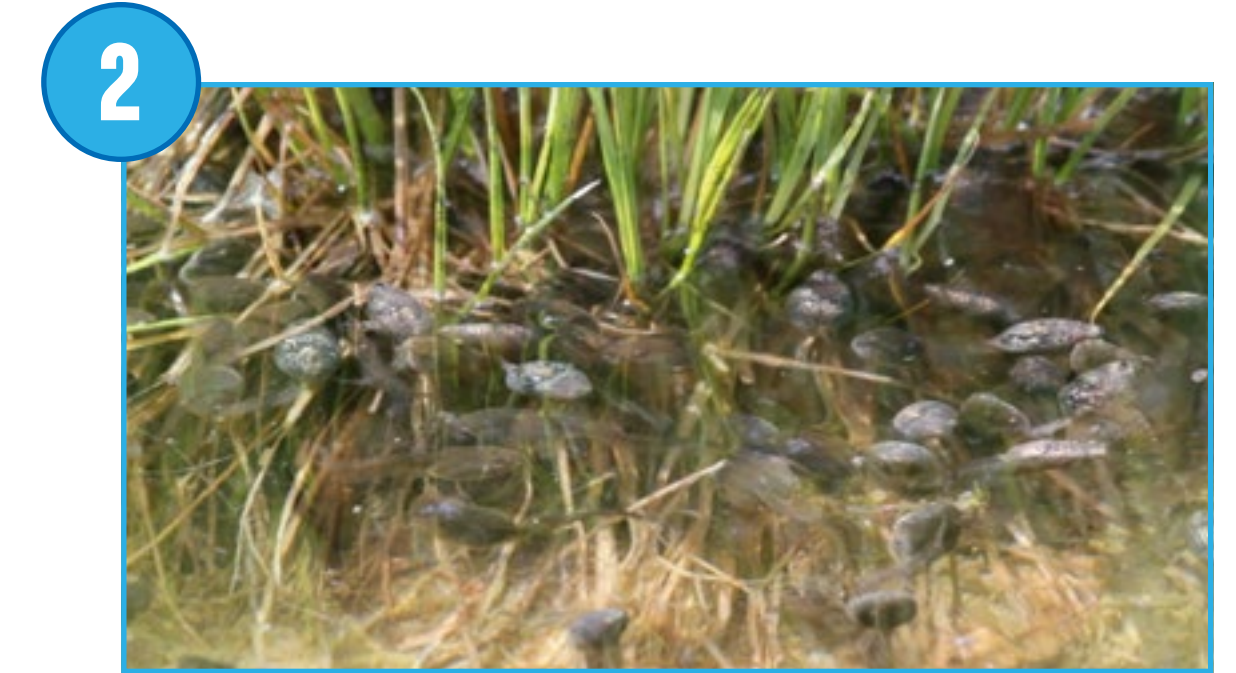



Explore phase

Questions for discussion

1. Which physical features change as a frog progresses from tadpole to adult?
The jaw changes shape, tail recedes, tongue for catching flies develops, hind legs and then front legs begin to grow, and lungs develop as gills disappear. This is merely a list of some of the most obvious changes that occur as a frog undergoes metamorphosis and is not intended to be an exhaustive description.
2. Are there links between the changes in a frog's physical characteristics and its habitat?
Animals morph to survive in new environments. Tadpoles often move from aquatic to terrestrial environments as they morph into adult frogs, so their bodies must support different ways of eating, breathing, and moving.

Your students can collect their answers in the Documentation tool.

Other questions to explore

1. In which ways are the life cycles of plants and animals similar?
Plants have similar life cycles to frogs because they both change shape during their lives and have a stage where they don't look like the adult stage (tadpole in the case of the frog, seedling in the case of the plant).
2. What are the stages in the life of a frog?
For frogs, it would be egg-->tadpole-->froglet (young frog)-->adult frog. For other animals, answers will vary.
3. Are frogs the only animals that go through metamorphoses during their life cycle?
No, butterflies and moths undergo complete metamorphoses, and dragonflies, certain fish, and various other organisms experience incomplete metamorphoses.
4. Do humans go through metamorphoses? How do you know?
Although the human body grows during its life cycle, it does not change.



Create phase

1. Build a model of a tadpole (larva).

Students will start to build a tadpole with only eyes, a long tail, and, at first, no front legs. Ask them to take a photograph of this stage or sketch it in order to document it before they morph it into the young frog.

2. Build a young frog model (froglet).

Students will follow the building instructions to morph the tadpole into a young frog that can move, if activated by a program. Ask the students to describe the changes they note as the model progresses.

One important new feature that has changed in the young frog model is the development of back legs. The walk module used in the project uses gears. These gears move the back legs.

Students should once again document their models using pictures and/or sketches.

3. Program the young frog.

This program will turn the motor on in one direction at motor power 8 for three seconds and then stop.

▶ Suggestion

Before your students start to modify their models, ask them to change the parameters of the program so that they fully understand it.





Create phase

Morphing from a young frog (froglet) to an adult frog

After building the young frog, students should modify it to create their own model.

There will be many possible solutions. Here are some examples:

1. Change both front and back legs.

The young frog will develop both front and back legs during its life. Students could build bigger legs in the back and create front legs. Students can also change the positions of the legs to show the different types of movements made by an adult frog. Students may modify their existing programs or create new programs to move the new legs.

2. Other changes in appearance.

Removing the tail, adding a mature tongue, changing the eye position, and adding patterns to the skin are additional ways to make the model look like an adult frog.

3. Replicate adult frog behaviour.

Students could use sounds or the Motion Sensor to change the frog's behaviour. For example, with a Motion Sensor placed on the frog's head, it could be programmed to wait until it detects an object such as a hand and then move backwards.

▶ Important

It is important to note that, because a student model will vary according to choice, there are no building instructions or sample programs provided to students for this part of the project.





Create phase

The “Use the model further” section of the student project is an optional extension. Keep in mind that these tasks extend on those of the “Use the model” section and are designed for older or more advanced students.

Use the model further

Frogs are amphibians that are very sensitive to the environment. For example, they have porous skin that can allow chemicals to affect their development.

Ask students to research the effects of damaging external factors on the frog life cycle. For example:

- Changes (such as damage or destruction) of habitats: Frogs would not be able to find a mate, move freely, or find food.
- Pollution or disease: Frogs could mutate by growing an extra leg or losing one.

Ask the students to use their models to illustrate the effects of such factors on frog behaviour and on the frog life cycle.

Suggestion

The framework for science education stresses that plants and animals have predictable characteristics relating to life processes, change, and growth. Animals and plants have similar growth processes, and offspring are related to the previous generations as inherent traits are realised. You could expand this modelling project to include other plants and animals.

Collaboration suggestion

Ask the teams to compare and share their findings and share information about the impact of external factors on frog populations.



Share phase

Complete the document

Ask the students to document their projects in different ways:

- Ask the students to take a photograph of every stage they create, and prepare to discuss how the model represents a frog's metamorphosis.
- Ask your students to compare images of their models with real-life images.
- Ask your students to record project presentation videos.

Present results

At the end of this project, students should present what they have learnt.

To enhance your students' presentation:

- Ask the students to explain the life cycle of the frog.
- Make sure that they can explain the different stages.
- Ask them to compare this life cycle with that of other animals.
- Ask them to describe the limitations of their model.
- Ask them to create a display that puts the frog's metamorphosis into context.

Frog's Metamorphosis

One possible way of sharing

Students in this class explain that morphing into an adult frog allows the creature to move from a water to a land environment.



Project 5

Plants and Pollinators

This project is about modelling a LEGO® representation of the relationship between a pollinator and a flower during the reproduction phase.





Curriculum links

Australian Curriculum: Science

Science Understanding

ACSSU073: Living things depend on each other and the environment to survive

Science as a Human Endeavour

ACSHE061: Science involves making predictions and describing patterns and relationships

Science Inquiry Skills

AC SIS064: With guidance, identify questions in familiar contexts that can be investigated scientifically and make predictions based on prior knowledge

AC SIS071: Represent and communicate observations, ideas, and findings using formal and informal representations





Curriculum links

Other Curriculum links

Australian Curriculum: Technologies Design and Technologies

Knowledge and Understanding

ACTDEK002: Explore how technologies use forces to create movement in products

ACTDEK020: Investigate how electrical energy can control movement, sound or light in a designed product or system

Processes and Production Skills

ACTDEP007: Use materials, components, tools, equipment, and techniques to safely make designed solutions

ACTDEP024: Critique needs or opportunities for designing, and investigate materials, components, tools, equipment, and processes to achieve intended designed solutions

Digital Technologies

Knowledge and Understanding

ACTDIK001: Recognise and explore digital systems (hardware and software components) for a purpose

ACTDIK007: Identify and explore a range of digital systems with peripheral devices for different purposes, and transmit different types of data

ACTDIK014: Examine the main components of common digital systems and how they may connect together to form networks to transmit data

Processes and Production Skills

ACTDIP004: Follow, describe, and represent a sequence of steps and decisions (algorithms) needed to solve simple problems

ACTDIP010: Define simple problems, and describe and follow a sequence of steps and decisions (algorithms) needed to solve them

ACTDIP011: Implement simple digital solutions as visual programs with algorithms involving branching (decisions) and user input

ACTDIP019: Design, modify, and follow simple algorithms involving sequences of steps, branching, and iteration (repetition)

ACTDIP020: Implement digital solutions as simple visual programs involving branching, iteration (repetition), and user input



Quick glance: Plan this WeDo 2.0 project

Preparation: 30 min.

- Read the general preparation in the “Classroom Management” chapter.
- Read about the project so you have a good idea of what to do.
- Define how you want to introduce this project: Use the video provided in the project in the WeDo 2.0 Software, or use material of your own choice.
- Determine the end result of this project: the parameters to present and produce the document.
- Make sure that timing allows for expectations to be met.

► Important

This project uses models to represent a real-world concept. Please refer to the “WeDo 2.0 in Curriculum” chapter for further explanations of modelling practices.

Explore phase: 30-60 min.

- Start the project using the introductory video.
- Hold a group discussion.
- Allow students to document their ideas for Max and Mia’s questions using the Documentation tool.

Create phase: 45-60 min.

- Ask the students to build the first model from the provided building instructions.
- Allow them to program the model using the sample program.
- Allow time so they can make different types of flowers and corresponding pollinators. Make sure that the students can explain the links between the two organisms.

Create more phase (optional): 45-60 min.

- You can use this extension of the project for differentiation or for older students.

Share phase: 45 min. or more

- Make sure your students document their work as they build new flowers and pollinators.
- Find different ways to let students share what they have learnt and their reflections on these experiences.
- Ask the students to create their final reports and present their projects.

► Suggestion

Have a look at the following “Open Projects” when you have completed this project:

- Animal Expression
- Wildlife Crossing



Differentiation

To ensure success, consider giving more guidance on building and programming, such as:

- Provide a list and images of potential pollinators.
- Provide a list of flower characteristics.

Be flexible about how the flowers are built and focus on what is most important: the general shape of the flower and its colour.

Be specific about how you would like them to present and document their findings. For example, a team sharing session.

Suggestion

For more experienced students, you may want to allow them extra time for building and programming so they can model more realistic flowers that include a stamen, stigma, petals, and other parts.

Use the model further

To use the model further, ask your students to explore the phases of the life cycle after the plant has been pollinated, such as seed dispersion.

Students' misconceptions

Students may believe that the main purpose of a pollinator is to be deliberately responsible for the reproduction of plants. It is more by chance that this phenomenon happens. The pollinator visits the flower with the intention of obtaining nutrients, and it is only indirectly that it transfers the pollen.

Vocabulary

Pollen

Powdery particles required for plant reproduction

Nectar

Liquid filled with sugar, produced by plants to attract animals

Seed

A plant embryo, provided in a protective shell

Stamen

Pollen-producing reproductive organ of a flower

Stigma

Pollen receptor organ of a flower

Pollinator

A living creature involved in the transport of pollen

Cross-pollination

Fertilisation of one plant by another



Scientific understanding assessment rubrics

You can use these assessment rubrics with the observation rubrics grid, which you will find in the “Assess with WeDo 2.0” chapter.

Explore phase

During the Explore phase, make sure that each student is actively involved in the discussion, asks and answers questions, and can answer questions in their own words.

1. The student is unable to adequately provide answers to questions or participate in discussions, or neglects to answer the questions posed during the Explore phase.
2. The student is able, with prompting, to adequately provide answers to questions or participate in discussions, and with prompting, answers some or all of the questions posed during the Explore phase.
3. The student is able to provide adequate answers to questions and participate in class discussions, and answer the questions posed during the Explore phase in his/her own words.
4. The student is able to extend the explanations in discussions and answer the questions posed during the Explore phase in his/her own words.

Create phase

During the Create phase, make sure that each student has developed a model that successfully demonstrates an animal’s role in the dispersion of seeds or the pollination of plants.

1. The student provides little or no evidence of an attempt to develop a model that demonstrates an animal’s role in the dispersion of seeds or the pollination of plants.
2. The student has attempted to develop a model that demonstrates an animal’s role in the dispersion of seeds or the pollination of plants, but some components of the model are incomplete or incorrect.
3. The student has developed a model that successfully demonstrates an animal’s role in the dispersion of seeds or the pollination of plants.

4. The student has developed an exceptional model that successfully demonstrates an animal’s role in the dispersion of seeds or the pollination of plants.

Share phase

During the Share phase, make sure that each student can explain what is happening in the pollination phase of a flower, and that they can identify the limitations of the model – what is realistic and unrealistic.

1. The student provides little, or no accurate explanation of what is happening in the pollination phase and is unable to identify the limitations of the model.
2. With prompting, the student can accurately explain what is happening in the pollination phase and may or may not identify the limitations of the model.
3. The student can explain, with accuracy, what is happening in the pollination phase and can identify specific limitations of the model.
4. The student can explain what is happening in the pollination phase, with ease and accuracy, and is able to clearly identify specific limitations of the model.



Presentation and problem-solving assessment rubrics

You can use these assessment rubrics with the observation rubrics grid, which you will find in the “Assess with WeDo 2.0” chapter.

Explore phase

During the Explore phase, make sure that each student can effectively explain their own ideas and comprehension related to the questions posed.

1. The student is unable to share his/her ideas related to the questions posed during the Explore phase.
2. The student is able, with prompting, to share his/her ideas related to the questions posed during the Explore phase.
3. The student adequately expresses his/her ideas related to the questions posed during the Explore phase.
4. The student uses details to extend explanations of his/her ideas related to the questions posed during the Explore phase.

Create phase

During the Create phase, make sure that each student uses precise language and appropriate vocabulary, and makes appropriate choices in communicating concepts using the Documentation tool.

1. The student does not use precise language or vocabulary appropriately and does not demonstrate thoughtful choices in communicating concepts with the Documentation tool.
2. With prompting, the student uses precise language and appropriate vocabulary, and makes appropriate choices in communicating concepts using the Documentation tool.
3. The student uses precise language and appropriate vocabulary, and makes appropriate choices in communicating concepts using the Documentation tool.
4. The student uses precise language and advanced vocabulary, and makes appropriate choices in communicating concepts using the Documentation tool.

Share phase

During the Share phase, make sure that each student provides reasons that are supported by scientific facts about pollination, to discuss how his/her model demonstrates animals' contribution to the life cycle of plants.

1. The student does not provide reasons or supporting facts about pollination to discuss how his/her model demonstrates animals' contribution to the life cycle of plants.
2. The student provides one reason that is supported by scientific facts about pollination to discuss how his/her model demonstrates animals' contribution to the life cycle of plants.
3. The student provides more than one reason supported by scientific facts about pollination to discuss how his/her model demonstrates animals' contribution to the life cycle of plants.
4. The student provides several reasons that are well supported by scientific facts about pollination to discuss how his/her model demonstrates animals' contribution to the life cycle of plants.



Explore phase

The introductory video may set the stage for the following ideas to be reviewed and discussed with students for this project.

Introductory video

Pollination is a vital process in which a flower is affected by an external factor in order to have the pollen transported to the stigma:

1. Flowers rely on external factors, such as wind or animals, to help them to reproduce.
2. The flower of a plant is designed to attract animals. The colour, size, smell, and the nectar are all designed by nature.
3. Butterflies and moths have long tongues that allow them to reach deep inside tubular flowers. They are particularly attracted to bright-red flowers.
4. Honeyeater birds have long beaks that are perfect for reaching the nectar deep inside tubular flowers.
5. Bats also play a role in pollination, using their very long tongues to get the nectar from flowers... mainly at night.

Pollination is only one step in a flowering plant's life cycle. After the flower has been pollinated, the fruit or the seed will develop on the plant. The plant then gets further assistance from animals or external forces, such as wind or rain, to disperse the seeds.

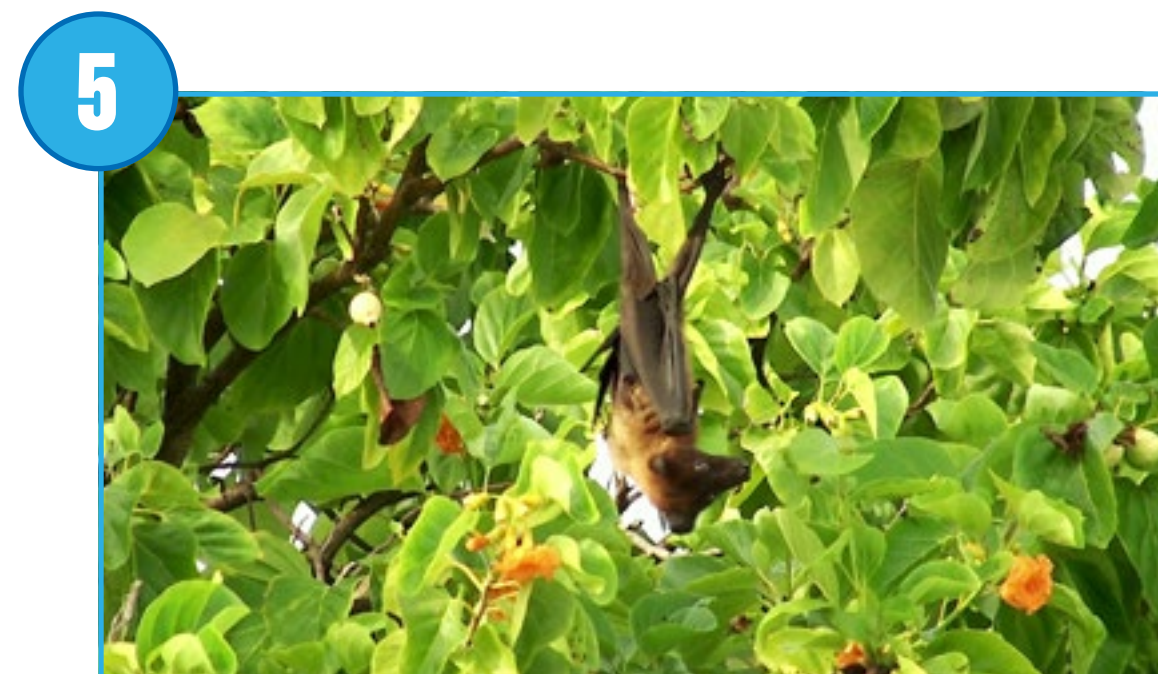
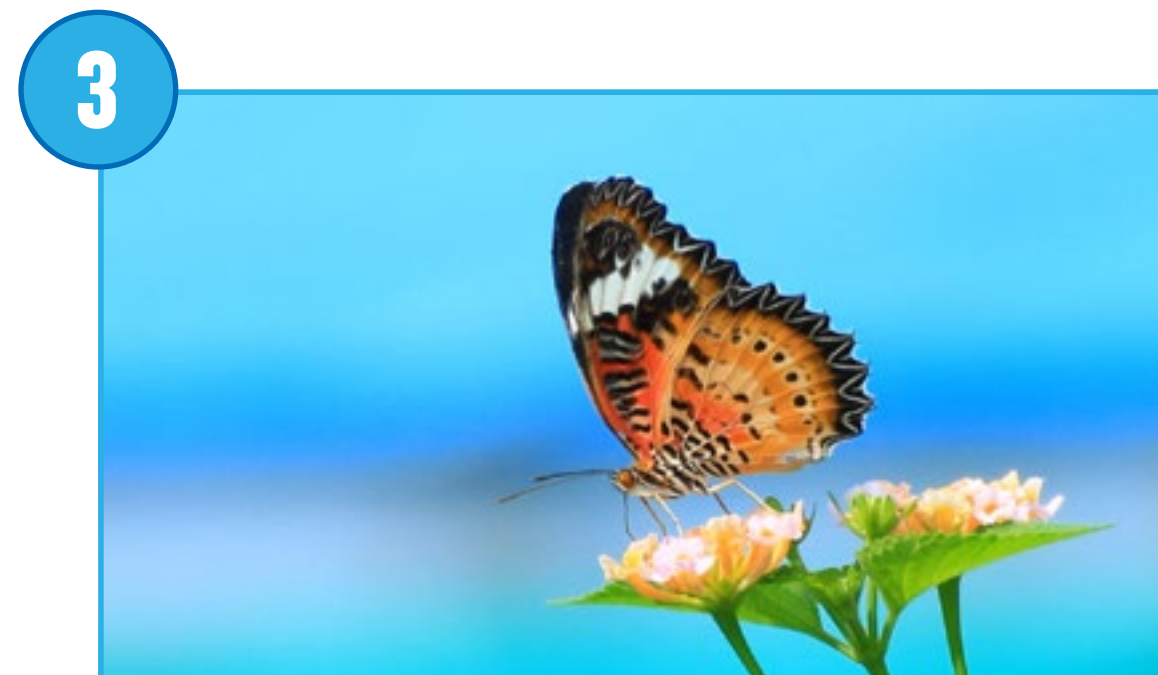
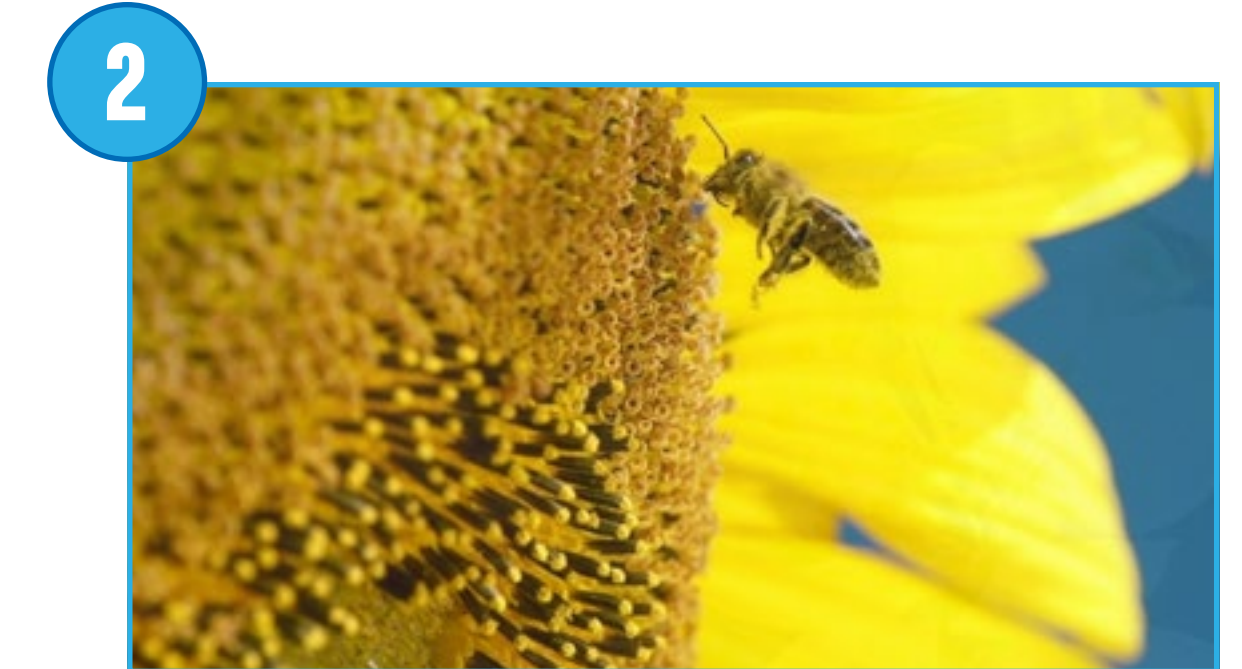



Explore phase

Questions for discussion

1. Name the different parts of a flower.
Anther, stamen, stigma, style, pollen, nectar
2. Explain different ways in which animals help plants to reproduce.
Pollinating animals go to the flower for nectar and will often get dusted with pollen, which is then transferred from one flower to the next. Most flowering plants rely on animals to pollinate them. Animals also help to disperse the seeds of many plants.
3. What are these processes called?
Pollination is the process by which flowers reproduce. Around 90 percent of all pollination on the planet involves organisms. This is called biotic pollination.

Ask your students to answer with text or pictures using the Documentation tool.

Other questions to explore

1. Name three stages in the life of a flowering plant.
Seed, seedling (tiny plant), and mature plant with flower
2. What is the role of a flower?
The flower is the organ developed by a plant to attract animals in order to get help in the reproductive process and create seeds.
3. Do all flowers get pollinated by a pollinator?
Some pollination takes place by wind or rain.



Create phase

Build and program a pollination model

Students will use the building instructions to create a model of a bee and a generic flower.

1. Build a pollination scenario.

This project model uses gears. These gears move on an axle to which the bee is attached. The flower uses a Motion Sensor to detect when the bee has landed on it.

2. Program the bee and the flower.

This program will turn the motor on in one direction until the bee is detected on top of the flower. When this happens, the motor will stop and a bee sound will be played.

Ask the students to use the transparent brick to represent the pollen.

▶ Suggestion

Before your students start to modify their model, ask them to change the parameters of the program so that they fully understand it.





Create phase

Describe a pollination scenario

Using ideas from the first model, the students should be able to change both the pollinator and the flower.

When the students have built the bee, ask them to think about how they might build a new flower and a pollinator that would be attracted to it.

Encourage students to plan and test their designs.

1. Build a new flower.

As an example, the students could build a tubular, brightly-coloured, or large flower. When they design their flowers, make sure that they:

- Keep the Motion Sensor in the new flower.
- Use the transparent brick to represent pollen.
- Design the correct pollinator for the flower.

2. Build a new pollinator.

As an example, students can build a honeyeater bird, butterfly, fly, bat, or any other organism they know is a pollinator. When they design their pollinator, make sure that they:

- Attach their new pollinator to the axle.
- Design the correct flower for the pollinator.

3. Program a new scenario.

As an example, students can use a second flower to illustrate cross-pollination.

To do that, make sure that they:

- Program the new pollinator to act differently from the previous model.

▶ Important

It is important to note that students' models will vary according to their individual choices, there are no building instructions or sample programs provided to students for this part of the project.

Collaboration suggestion

Teams working together can discuss, for example, if the pollinator of one type of flower can pollinate another type of flower and vice versa.



Create phase

The “Use the model further” section of the student project is an optional extension. Keep in mind that these tasks extend upon those of the “Use the model” section and are designed for older or more advanced students.

Use the model further

After the flower is pollinated, seeds or fruit appear on the plant.

1. Build and program a seed dispersion scenario.

Ask the students to modify the plant after the flower has been pollinated. Ask the students to explore the different types of seed dispersal. Ask them to pick one and create a model to represent it.

For example:

- Seeds hidden inside an attractive fruit to be eaten by an animal
- Seeds carried by animals and birds
- Seeds transported by wind or water
- Seeds that have self-propulsion mechanisms



Share phase

Complete the document

Ask the students to include a picture of every stage of the pollination process, in their final products:

- Ask your students to compare these images with real-life images.
- Ask your students to record a video of themselves describing how animals help plants to reproduce.

Present results

At the end of this project, students should present what they have learnt.

To enhance your students' presentations:

- Ask the students to use the model to explain the relationship between the pollinator and the flower in the context of a plant's life cycle.
- Make sure that they can explain why and how the pollinator plays an active role in the pollination process.
- Ask them to put some context into their explanation, such as describing where the flower is, or in what season the event is taking place.

Plants and Pollinators

One possible way of sharing

Students in this class use their models to explain how a bee can pollinate a flower.



Project 6

Prevent Flooding

This project is about designing an automatic LEGO® floodgate to control water according to various precipitation patterns.

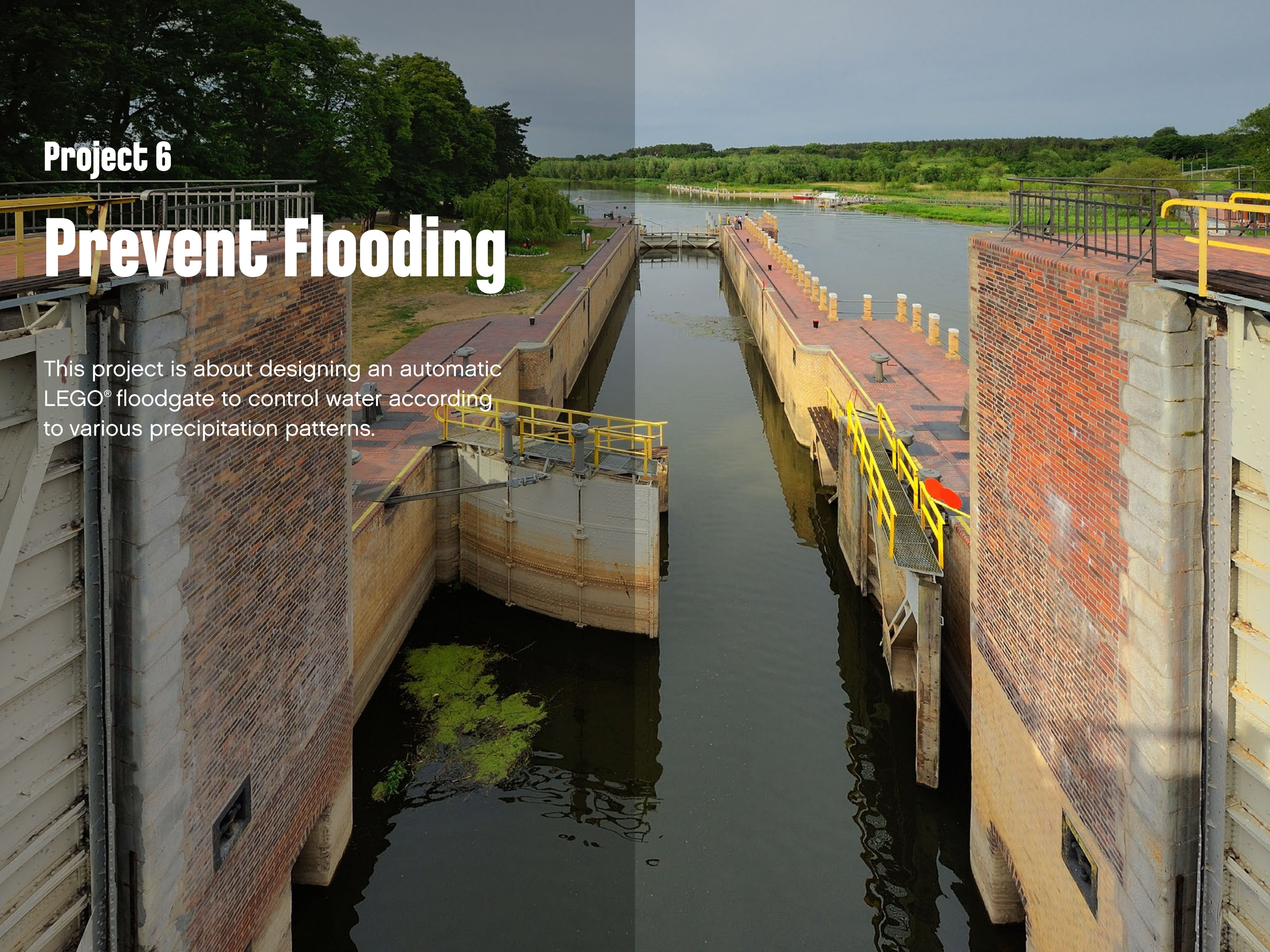



Curriculum links

Australian Curriculum: Science

Science Understanding

ACSSU075: Earth's surface changes over time as a result of natural processes and human activity

ACSSU096: Sudden geological changes and extreme weather events can affect Earth's surface

Science as a Human Endeavour

ACSHE061: Science involves making predictions and describing patterns and relationships

ACSHE062: Science knowledge helps people to understand the effect of their actions

ACSHE098: Science involves testing predictions by gathering data and using evidence to develop explanations of events and phenomena and reflects historical and cultural contributions

Science Inquiry Skills

AC SIS064: With guidance, identify questions in familiar contexts that can be investigated scientifically and make predictions based on prior knowledge

AC SIS071: Represent and communicate observations, ideas, and findings using formal and informal representations

AC SIS232: With guidance, pose clarifying questions and make predictions about scientific investigations

AC SIS103: Identify, plan, and apply the elements of scientific investigations to answer questions and solve problems using equipment and materials safely and identifying potential risks

AC SIS110: Communicate ideas, explanations, and processes using scientific representations in a variety of ways, including multi-modal texts

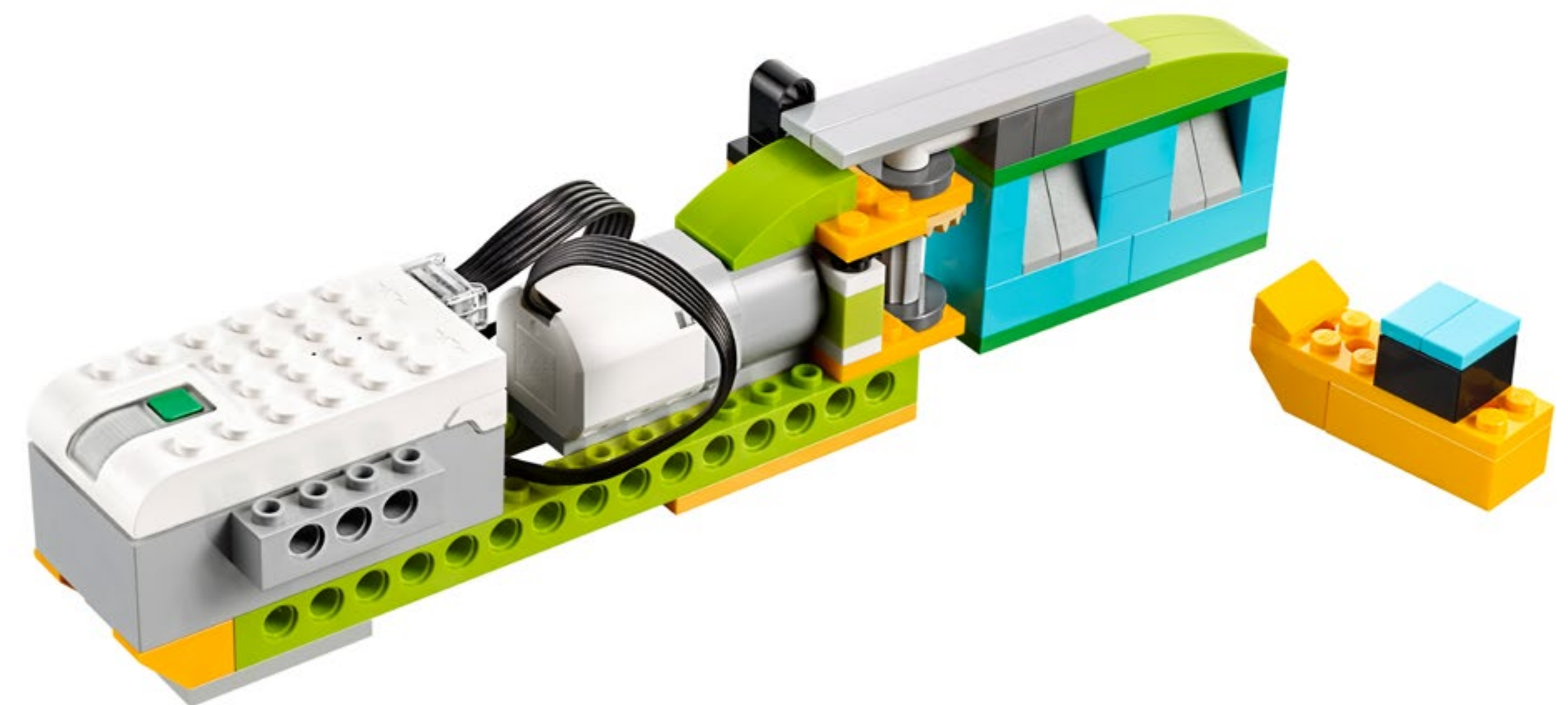



Curriculum links

Other Curriculum links

Australian Curriculum: Technologies Design and Technologies

Knowledge and Understanding

ACTDEK011: Investigate how forces and the properties of materials affect the behaviour of a product or system

ACTDEK019: Examine how people in design and technologies occupations address competing considerations, including sustainability in the design of products, services, and environments for current and future use

ACTDEK020: Investigate how electrical energy can control movement, sound, or light in a designed product or system

ACTDEK023: Investigate characteristics and properties of a range of materials, systems, components, tools, and equipment and evaluate the impact of their use

Processes and Production Skills

ACTDEP016: Select and use materials, components, tools, equipment, and techniques and use safe work practices to make designed solutions

ACTDEP017: Evaluate design ideas, processes, and solutions based on criteria for success developed with guidance and including care for the environment

ACTDEP024: Critique needs or opportunities for designing, and investigate materials, components, tools, equipment, and processes to achieve intended designed solutions

Digital Technologies

Knowledge and Understanding

ACTDIK007: Identify and explore a range of digital systems with peripheral devices for different purposes, and transmit different types of data

ACTDIK014: Examine the main components of common digital systems and how they may connect together to form networks to transmit data

Processes and Production Skills

ACTDIP011: Implement simple digital solutions as visual programs with algorithms involving branching (decisions) and user input

ACTDIP019: Design, modify, and follow simple algorithms involving sequences of steps, branching, and iteration (repetition)

ACTDIP020: Implement digital solutions as simple visual programs involving branching, iteration (repetition), and user input



Quick glance: Plan this WeDo 2.0 project

Preparation: 30 min.

- For information regarding general preparation, please see the “Classroom Management” chapter.
- Read about the project so you have a good idea of what to do.
- Define how you want to introduce this project: Use the video provided in the project in the WeDo 2.0 Software, or use material of your own choice.
- Determine the end result of this project: the parameters to present and produce the document.
- Make sure that timing allows for expectations to be met.

▶ Important

This project is a design brief. Please refer to the “WeDo 2.0 in Curriculum” chapter for further explanations of design practices.

Explore phase: 30-60 min.

- Start the project using the introductory video.
- Hold a group discussion.
- Allow students to document their ideas for Max and Mia’s questions using the Documentation tool.

Create phase: 45-60 min.

- Ask the students to build the first model from the provided building instructions.
- Allow them to program the model using the sample program.
- Allow time for them to build different devices to create automatic doors.

Create more phase (optional): 45-60 min.

- You can use this extension of the project for differentiation or for older students.

Share phase: 45 min. or more

- Make sure your students document their findings as they work with sensors.
- Allow the students to share their experiences in different ways.
- Ask the students to create their final science reports and present their projects.

▶ Suggestion

Have a look at the following “Open Projects” when you have completed this project:

- Hazard Alarm
- Extreme Habitats



Differentiation

To ensure success, consider giving more guidance on building and programming, such as:

- Explain how to use sensors.
- Define the types of precipitation for each season together with your students, and help them to determine which season they will focus on.
- Explain engineering-based design.

Be specific about how you would like them to present and document their findings. For example, a team sharing session.

Suggestion

For more experienced students, you may want to allow them extra time for building and programming to allow them to create different and more extensive types of devices. Ask them to use the design process to explain all of the versions they make.

Design further solutions

When designing further solutions, ask the students to use their knowledge of floodgates and different water sources to describe the body of water they are trying to control, and to take into consideration the position of mountains, cities, and lakes. Provide them with opportunities to expand the design process to include other ideas about how floodgates and other types of automatic doors function.

Students' misconceptions

Students tend to view the earth as static, stable, and unchanging. They often have difficulty comprehending that rocks can be worn down through the process of weathering. They often have difficulty understanding the role of dams or floodgates in the protection of land masses.

Vocabulary

Floodgate

An adjustable gate used to control the flow of water

Sluice

A sliding gate or other device for controlling the flow of water

Dyke

A wall or embankment that prevents the flow of water

Upstream

Moving in the opposite direction to the water flow

Downstream

Moving in same direction as the water flow

Precipitation

Any form of water, such as rain, snow, sleet, or hail, that falls to the earth's surface

Dam

A barrier that impounds water or underground streams

Erosion

The process in which earth is worn away, often by water, wind, or ice

Automate

Convert a process or facility to work on its own, operated by a machine or computer.



Scientific understanding assessment rubrics

You can use these assessment rubrics with the observation rubrics grid, which you will find in the “Assess with WeDo 2.0” chapter.

Explore phase

During the Explore phase, make sure that each student is actively involved in the discussion, asks and answers questions, and can create a graph of precipitation for each season.

1. The student is unable to provide answers to questions or participate in discussions adequately, or create a graph of precipitation for each season.
2. The student is able, with prompting, to adequately provide answers to questions, participate in discussions, and with help, can create a graph of precipitation for each season.
3. The student is able to provide adequate answers to questions, participate in class discussions, and create a graph of precipitation for each season.
4. The student is able to extend on explanations during discussions and can create a graph of precipitation for each season.

Create phase

During the Create phase, make sure that each student works well as part of a team, justifies his/her best solution, and utilises the information gathered during the Explore phase.

1. The student is unable to work as part of a team, justify solutions, or use gathered information for further development.
2. The student is able to work as part of a team, gather and use information with guidance, or, with help, can justify solutions.
3. The student is able to work as part of a team, contribute to the team discussions, justify solutions, and gather and use information.
4. The student is able to work as part of a team, serve as the team leader, and can justify and discuss solutions that allow for the gathering and use of information.

Share phase

During the Share phase, make sure that each student can explain how the design for the floodgate was created, has used sensors to control the floodgate, and can use important information gathered during the project to create a final report.

1. The student is unable to engage in the discussions about the design, explain the model's use of sensors, or use gathered information to create a final project.
2. The student is able, with prompting, to engage in the discussions about the design of the floodgate and the model's use of sensors, and can use limited information to create a final project.
3. The student is able to engage in discussions about the design of the floodgate and the model's use of sensors, and can use gathered information to produce a final project.
4. The student is able to engage extensively in class discussions about the topic, and can use gathered information to create a final project that includes additional elements.



Presentation and problem-solving assessment rubrics

You can use these assessment rubrics with the observation rubrics grid, which you will find in the “Assess with WeDo 2.0” chapter.

Explore phase

During the Explore phase, make sure that each student can effectively explain their own ideas and comprehension related to the questions posed.

1. The student is unable to share his/her ideas related to the questions posed during the Explore phase.
2. The student is able, with prompting, to share his/her ideas related to the questions posed during the Explore phase.
3. The student adequately expresses his/her ideas related to the questions posed during the Explore phase.
4. The student uses details to extend explanations of his/her ideas related to the questions posed during the Explore phase.

Create phase

During the Create phase, make sure that each student makes appropriate choices (i.e., screenshot, image, video, text) and follows the established expectations for documenting their findings.

1. The student fails to document findings throughout the investigation.
2. The student documents his/her findings, but the documentation is incomplete or does not comply with all of the established expectations.
3. The student adequately documents his/her findings for each part of the investigation and makes appropriate choices and selections.
4. The student uses a variety of appropriate methods for documentation and exceeds the established expectations.

Share phase

During the Share phase, make sure that each student uses the evidence that they gathered during their investigations to justify their reasoning, and that they adhere to established guidelines when presenting their findings to an audience.

1. The student does not use evidence from his/her findings in connection with the ideas shared during the presentation. The student does not follow the established guidelines.
2. The student uses some evidence from his/her findings, but the justification is limited. Established guidelines are generally followed, but may be lacking in one or more areas.
3. The student adequately provides evidence to justify his/her findings and follows established guidelines for presenting.
4. The student fully discusses his/her findings and thoroughly utilises appropriate evidence to justify his/her reasoning, while following all established guidelines.



Explore phase

The introductory video may set the stage for the following ideas to be reviewed and discussed with students for this project.

Introductory video

For many centuries, humans have created devices to prevent water from flooding populated areas:

1. Weather brings various types of precipitation during the year.
2. Sometimes, there is so much water that rivers and streams break their banks.
3. Erosion is a natural phenomenon that occurs in areas with high precipitation.
4. Floodgates allow water to flow downstream in canals or rivers.
5. During periods of regular precipitation, the floodgates are opened to keep the level of the reservoir low.
6. During periods of high precipitation, the floodgates are closed to fill the reservoir with the extra water.

You can compare the idea of floodgates to filling a bathtub:

- Opening the floodgates allows the water from upstream to flow downstream, just like running a tap into a bathtub with the plug removed; allowing the water to escape down the drain.
- Closing the floodgates completely would stop the water flow and cause flooding upstream. Just like running a tap into a bathtub with the plug inserted; the bathtub would fill up and eventually overflow.

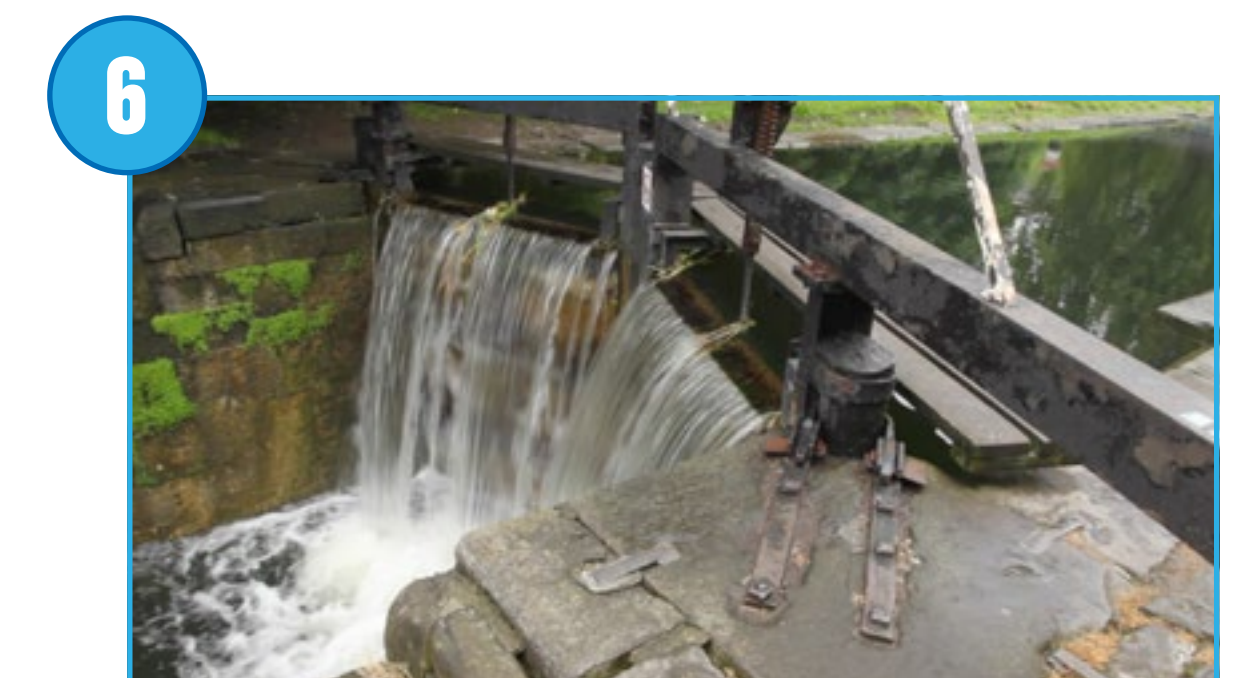
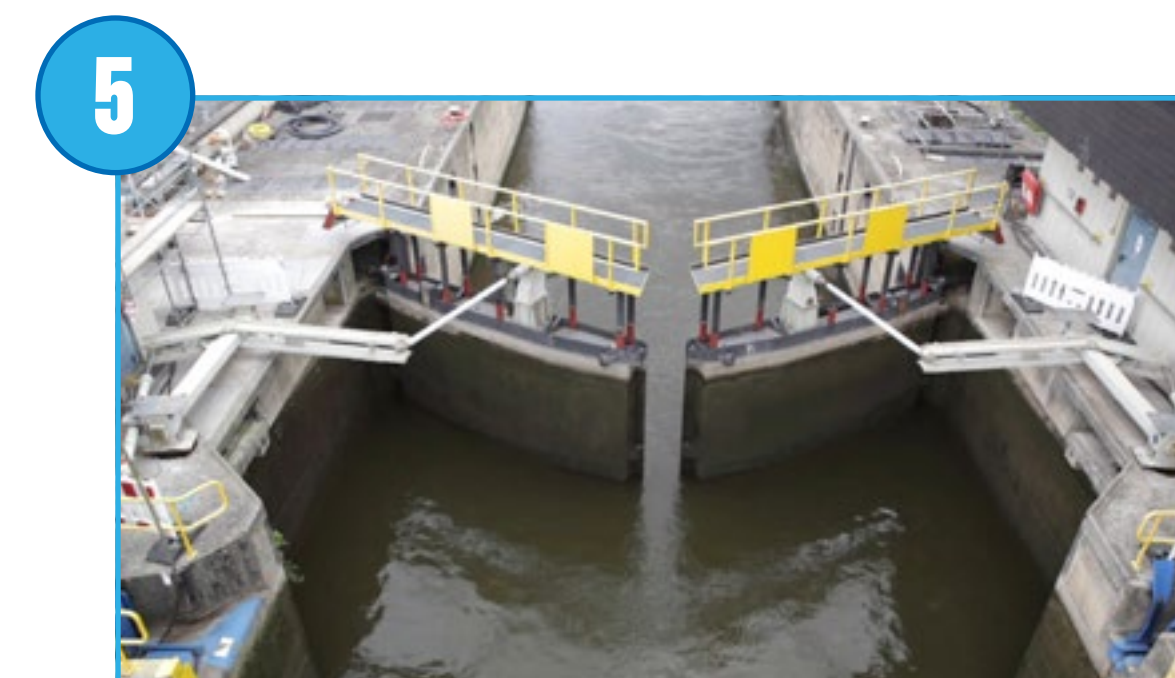
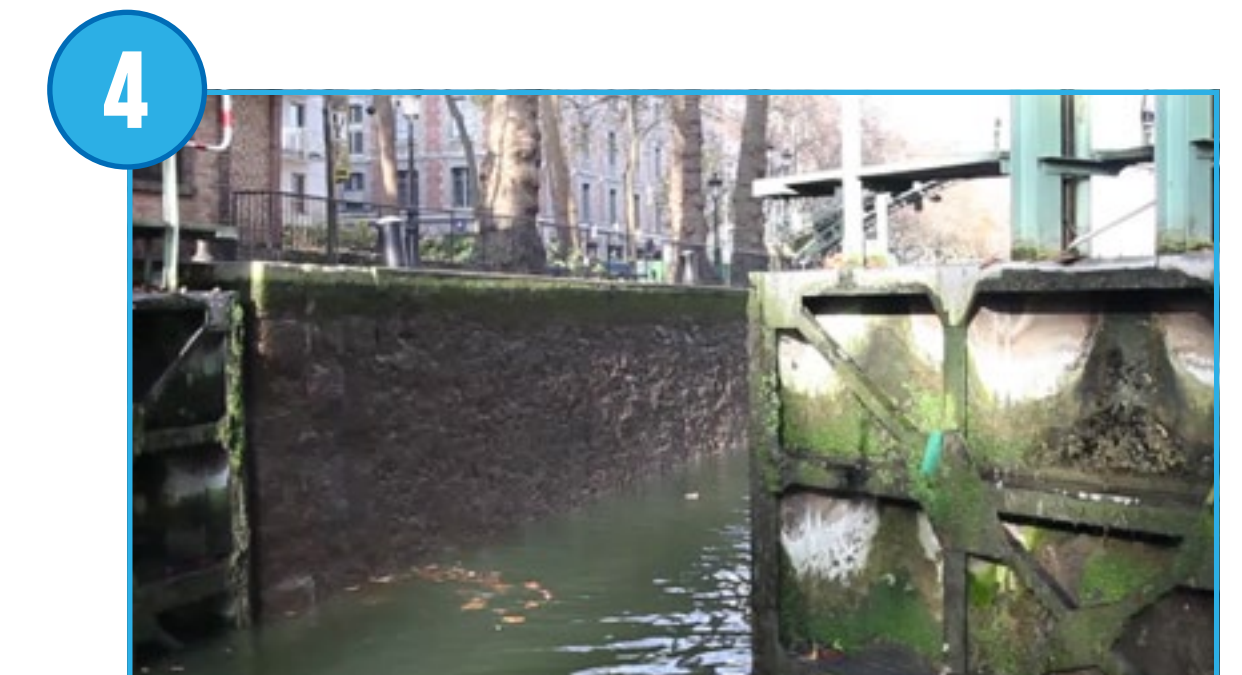
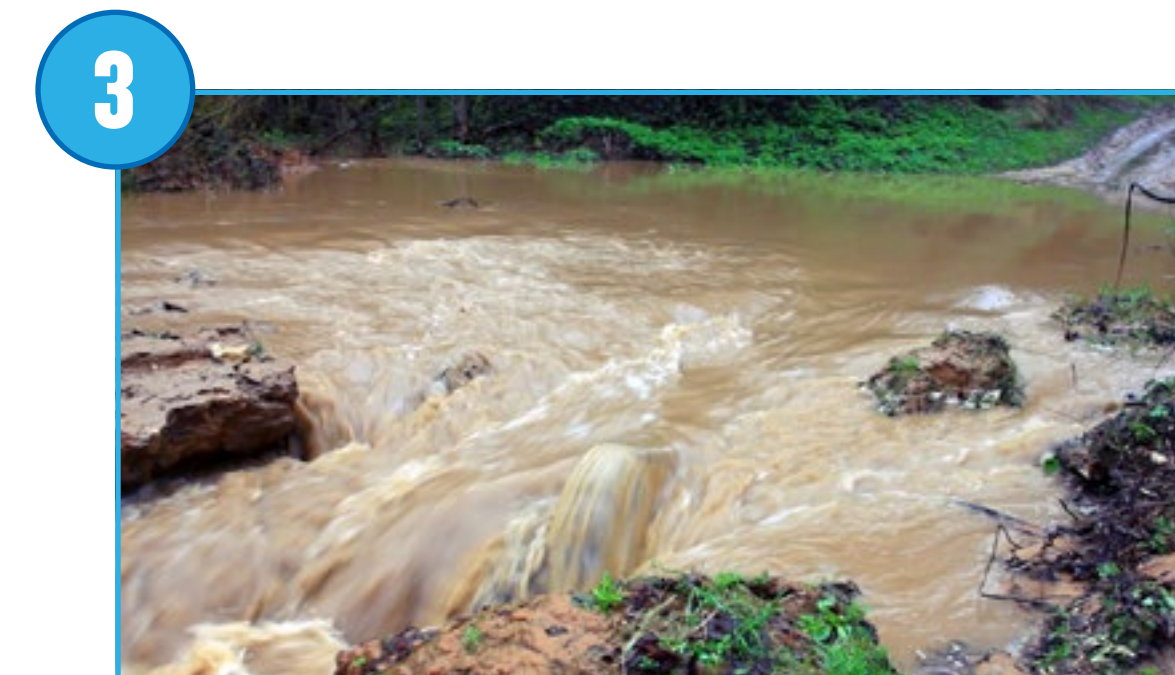
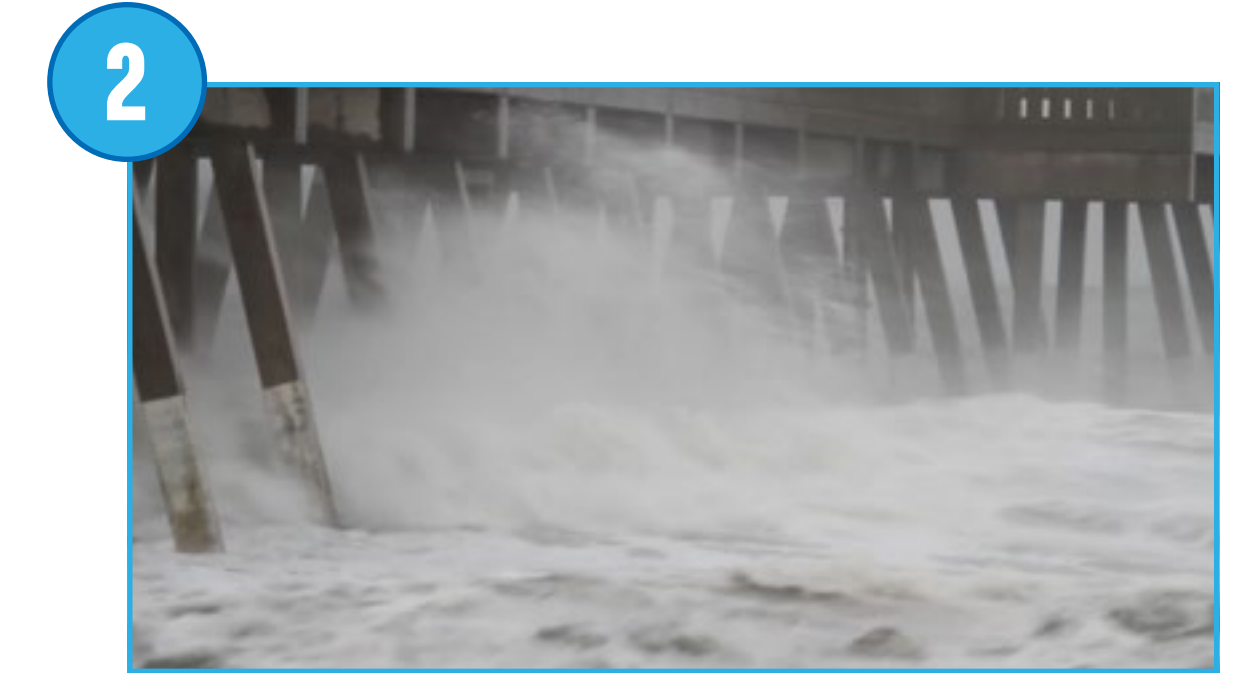
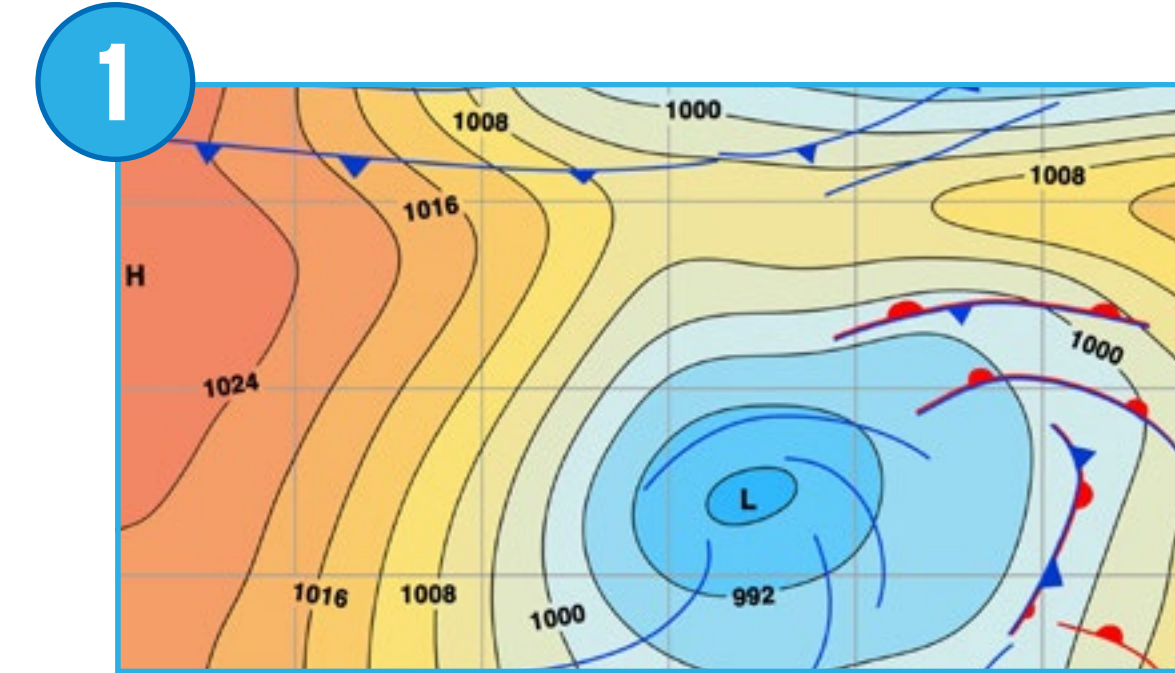



Explore phase

Questions for discussion

1. Use a bar graph to describe the precipitation levels for each season in your part of the world.
The answer to this question will vary according to your location. Use descriptive words such as high rain season, low rain season, and flooding.
The bar should show high, medium, and low precipitation.
2. How does precipitation influence the water level of rivers?
Precipitation is not the only factor that influences the water level of rivers, but in general:
 - High precipitation raises the water level.
 - Low precipitation lowers the water level.
3. List ways in which a flood can be prevented.
There are many ways in which we can prevent flooding, for example, dykes, dams, trenches, and reforestation.
4. Imagine a device that can prevent flooding from occurring.
The answer to this question will guide students to the design process.

Ask your students to answer with text or pictures using the Documentation tool.

Other questions to explore

1. What is water erosion?
Water erosion is a natural process by which water changes the shape of the land.
2. How is this bar graph different from the bar graph of your own region?
The answer to this question will vary according to each student's location.



Create phase

Build and program a floodgate

Students will follow the building instructions to create a floodgate. This gate can be closed and opened using the motor.

1. Build a floodgate.

The module used in this project uses a bevel gear. This bevel gear can change the axis of rotation, allowing the floodgate to open and close.

2. Program the model to open and close the floodgate.

This program will display the image of the precipitation and run the motor in one direction for two seconds. When the other Start Block is pressed, it will display an image of the sun and run the motor in the opposite direction for two seconds.

► Important

The use of the bar graph should help the students to explain why they need to close or open the floodgate.

► Suggestion

Before your students begin designing their solutions, ask them to adjust the parameters of the program so that they fully understand it.

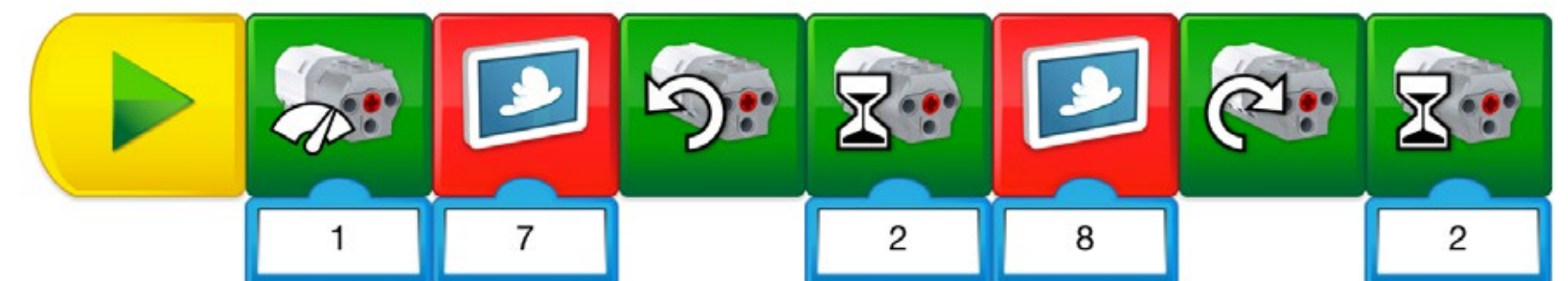



Create phase

Automate the floodgate

The students should add sensors to their models to make them react to the environment. They should consider at least one of these options:

1. Add a Tilt Sensor handle to operate the gate.

A Tilt Sensor handle will allow the operator to open and close the gate.

2. Add a Motion Sensor to detect rising water.

A Motion Sensor will let you open and close the door according to water levels. Use your hands or LEGO® bricks to simulate different water levels.

3. Add a Sound Sensor Input to activate emergency protocol.

The emergency protocol can be used to play a sound, flash the lights, send a text message, or close the floodgates.

► Important

It is important to note that students' models will vary according to their individual choices, there are no building instructions or sample programs provided to students for this part of the project.

► Suggestion

Students can refer to the Design Library for inspiration.



Create phase

Use the “Design new solutions” section of the student project as an optional extension. Keep in mind that these tasks are an extension of the “Design a solution” section and are meant for older or more advanced students.

Design further solutions

Flooding and erosion do not just happen anywhere.

1. Draw a map of the floodgate location, including the land and river areas:

- Ask your students to create a map or a display of the river with other elements, such as mountains, valleys, or cities.
- Ask them to describe where a floodgate might be used.
- Ask them to illustrate where the water comes from and where it goes to.

2. Find other uses for a floodgate.

You could use the floodgate in situations other than a flood. Ask your students to think of gates and doors in general.

Collaboration suggestion

The floodgate can also be used in a canal navigation scenario. Pair up teams and ask them to illustrate what might happen in a boat transportation sequence.

3. Program two floodgates to control the navigation of water in and out of a section of the river.

Ask the students to describe and program the sequence for operating the floodgates.



Share phase

Complete the document

Ask the students to document their projects in different ways:

- Ask the students to take photographs of each version they create. Ask them to explain which is the best solution and provide evidence for their reasoning.
- Ask your students to compare these images with real-life images.
- Ask your students to record project presentation videos.

Present results

In this project, the students should explain how the sensors are incorporated into their models.

To enhance your students' presentations:

- Make sure that they can explain why the floodgates can prevent water from changing the shape of the land.
- Ask them to put their explanation into context: Where is it occurring?
In which season? Under what conditions?

Project 7

Drop and Rescue

This project is about designing a device to reduce the impact caused by a weather-related hazard on humans, animals, and the environment.





Curriculum links

Australian Curriculum: Science

Science Understanding

ACSSU096: Sudden geological changes or extreme weather conditions can affect Earth's surface

Science as a Human Endeavour

ACSHE100: Scientific knowledge is used to solve problems and inform personal and community decisions

Science Inquiry Skills

AC SIS103: Identify, plan, and apply the elements of scientific investigations to answer questions and solve problems using equipment and materials safely and identifying potential risks

AC SIS110: Communicate ideas, explanations, and processes using scientific representations in a variety of ways, including multi-modal texts

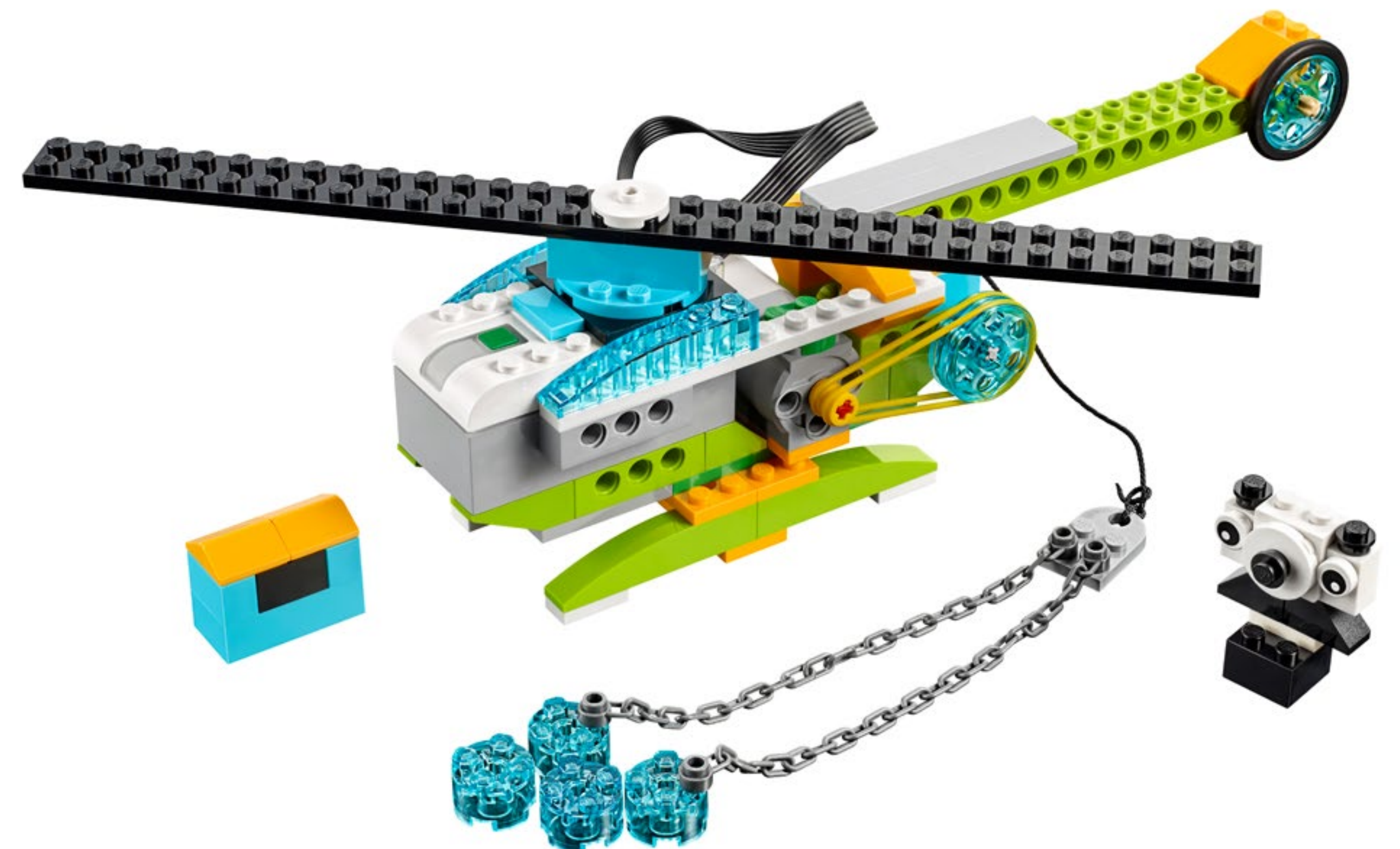



Curriculum links

Other Curriculum links

Australian Curriculum: Technologies Design and Technologies

Knowledge and Understanding

ACTDEK011: Investigate how forces and the properties of materials affect the behaviour of a product or system

ACTDEK019: Examine how people in design and technologies occupations address competing considerations, including sustainability in the design of products, services, and environments for current and future use

Processes and Production Skills

ACTDEP016: Select and use materials, components, tools, equipment, and techniques and use safe work practices to make designed solutions

ACTDEP017: Evaluate design ideas, processes, and solutions based on criteria for success developed with guidance and including care for the environment

ACTDEP024: Critique needs or opportunities for designing, and investigate materials, components, tools, equipment, and processes to achieve intended designed solutions

Digital Technologies

Knowledge and Understanding

ACTDIK007: Identify and explore a range of digital systems with peripheral devices for different purposes, and transmit different types of data

ACTDIK014: Examine the main components of common digital systems and how they may connect together to form networks to transmit data

Processes and Production Skills

ACTDIP011: Implement simple digital solutions as visual programs with algorithms involving branching (decisions) and user input

ACTDIP019: Design, modify, and follow simple algorithms involving sequences of steps, branching, and iteration (repetition)

ACTDIP020: Implement digital solutions as simple visual programs involving branching, iteration (repetition), and user input



Quick glance: Plan this WeDo 2.0 project

Preparation: 30 min.

- Read the general preparation in the “Classroom Management” chapter.
- Read about the project so you have a good idea of what to do.
- Define how you want to introduce this project: Use the video provided in the project in the WeDo 2.0 Software, or use material of your own choice.
- Determine the end result of this project: the parameters to present and produce the document.
- Make sure that timing allows for expectations to be met.

► Important

This project is a design brief. Please refer to the “WeDo 2.0 in Curriculum” chapter for further explanations of design practices.

Explore phase: 30-60 min.

- Start the project using the introductory video.
- Hold a group discussion.
- Allow the students to document their ideas for Max and Mia’s questions using the Documentation tool.

Create phase: 45-60 min.

- Ask the students to build the first model using the provided building instructions.
- Allow them to program the model using the sample program.
- Allow time for them to design two different prototypes for one of the rescue missions: relocate an endangered animal, drop materials to help people, or drop water to put out fires.

Create more phase (optional): 45-60 min.

- You can use this extension of the project for differentiation or for older students.

Share phase: 45 min. or more

- Make sure that your students document the results of each mission.
- Ask the students to share the reasoning behind the designs of their prototypes for each mission.
- Ask them to discuss the engineering-based design process and ways that they had to change or adjust the prototypes.
- Ask the students to create their final presentations.
- Find different ways to let the students share their results.
- Ask the students to present their projects.

► Suggestion

Have a look at the following “Open Projects” when you have completed this project:

- [Cleaning the Ocean](#)
- [Space Exploration](#)



Differentiation

To ensure success, consider giving more guidance on building and programming, such as:

- Make sure that the students understand the problem they have to solve.
- Ask them to write a text or record a video describing the problem.
- Explain engineering-based design.
- Explain how to use sensors.

Be specific about how you would like them to present and document their findings. For example, a team sharing session.

Suggestion

You may want to ask the more experienced students to use the Tilt Sensor to control the up-and-down movement of the string.

Design further solutions

To extend this part of the project, ask the students to design a completely new solution to the problem, moving away from the helicopter into something different.

Students' misconceptions

It is possible that students will only articulate experiences about what they can imagine happening within their own local environments. For example, students from coastal communities may only consider sea rescue. Ask the students to project themselves into another context and to explore solutions to problems within that environment.

Vocabulary

Stretcher

A special apparatus designed to move injured or endangered people or animals

Rescue

Responsive operations that save lives or prevent further danger to inhabitants of an affected area

Prototype

Early sample or model that is used to test a concept

Weather

The daily conditions of the atmosphere in terms of temperature, atmospheric pressure, wind, and moisture

Weather-related hazard

A group of natural hazards caused by weather



Scientific understanding assessment rubrics

You can use these assessment rubrics with the observation rubrics grid, which you will find in the “Assess with WeDo 2.0” chapter.

Explore phase

During the Explore phase, make sure that each student is actively involved in the discussion, asks and answers questions, and can describe, in their own words, the problem that they have to solve in each mission.

1. The student is unable to provide answers to questions, participate in discussions, or adequately describe the problem to be solved in each mission.
2. The student is able, with prompting, to adequately provide answers to questions, participate in discussions, and with help, can give a basic description of the problem to be solved in each mission.
3. The student is able to provide adequate answers to questions, participate in class discussions, and describe the problem to be solved in each mission.
4. The student is able to extend the explanations in discussions or describe the problem to be solved in each mission.

Create phase

During the Create phase, make sure that each student is able to work as part of a team, can discuss what they think is the best solution for each mission, and uses the information gathered in the Explore phase to suggest prototype solutions for each mission.

1. The student is unable to work well as part of a team, cannot discuss the best solution for each mission, and does not demonstrate the ability to use the engineering design process to solve problems.
2. The student is able to solve problems as part of a team, can discuss the best solution for each mission, and, with help, can demonstrate the use of the engineering design process to gather and use information to solve problems.

3. The student is able to work as part of a team, contributes to discussions, and can demonstrate the use of the engineering design process to gather and use information to solve problems.
4. The student is able to work as a team leader and extend the use of engineering-based design to gather and use information to solve problems in many ways.

Share phase

During the Share phase, make sure that each student can describe the different solutions that he/she has developed for each mission, explain how their solution can solve the problem they have identified for each mission, and use important information from their project to create their final report.

1. The student is unable to engage in discussions about the mission or design processes, and cannot explain the solutions to the problems posed or use the information to create a final project.
2. The student is able, with prompting, to engage in discussions about design processes as well as demonstrate, with limited ability, the use of information to solve real-world problems and create a project.
3. The student is able to engage in discussions about design processes or use gathered information to produce a final project that presents solutions for the posed problems.
4. The student is able to engage extensively in class discussions about the topic and uses gathered information to create a final project that includes additional required elements.



Presentation and problem-solving assessment rubrics

You can use these assessment rubrics with the observation rubrics grid, which you will find in the “Assess with WeDo 2.0” chapter.

Explore phase

During the Explore phase, make sure that each student can effectively explain his/her own ideas and comprehension related to the questions posed.

1. The student is unable to share his/her ideas related to the questions posed during the Explore phase.
2. The student is able, with prompting, to share his/her ideas related to the questions posed during the Explore phase.
3. The student adequately expresses his/her ideas related to the questions posed during the Explore phase.
4. The student uses details to extend on explanations of his/her ideas related to the questions posed during the Explore phase.

Create phase

During the Create phase, make sure that each student makes appropriate choices (i.e., screenshot, image, video, text) and follows the established expectations for documenting their findings.

1. The student fails to document findings throughout the investigation.
2. The student documents his/her findings, but the documentation is incomplete or does not comply with all of the established expectations.
3. The student adequately documents findings for each part of the investigation and makes appropriate choices and selections.
4. The student uses a variety of appropriate methods for documentation and exceeds the established expectations.

Share phase

During the Share phase, make sure that each student uses the evidence that they gathered during their investigations to justify their reasoning, and that they adhere to established guidelines when presenting their findings to an audience.

1. The student does not use evidence from his/her findings when sharing ideas during the presentation. The student does not follow the established guidelines.
2. The student uses some evidence from his/her findings, but the justification is limited. Established guidelines are generally followed but may be lacking in one or more areas.
3. The student adequately provides evidence to justify his/her findings and follows established guidelines for presenting.
4. The student fully discusses his/her findings and thoroughly utilises appropriate evidence to justify his/her reasoning, while following all established guidelines.



Explore phase

The introductory video may set the stage for the following ideas to be reviewed and discussed with students for this project.

Introductory video

Serious weather-related hazards can destroy areas very quickly and violently. When this happens, animals and people can be in danger:

1. Lightning storms are responsible for a lot of natural fires.
2. When fire starts, it can destroy habitats very quickly.
3. Strong winds and floods can also be hazardous.
4. In extreme cases, authorities launch rescue missions.
5. Helicopters can be used to airlift animals and people out of danger zones or bring vital supplies to those in need.

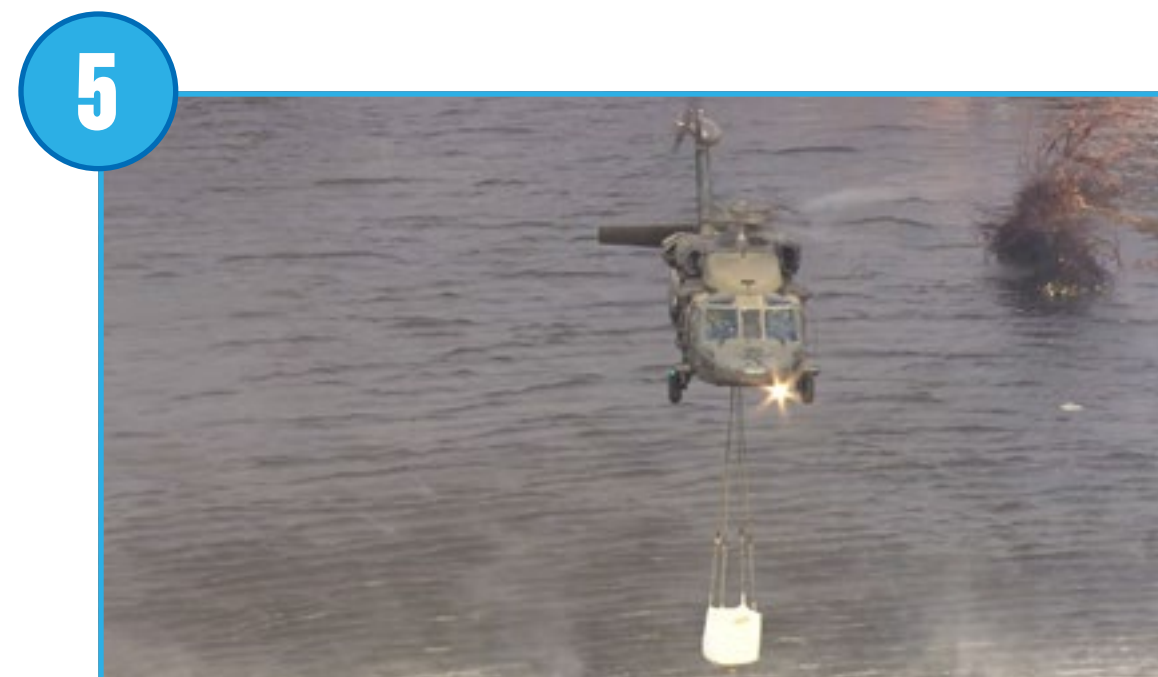
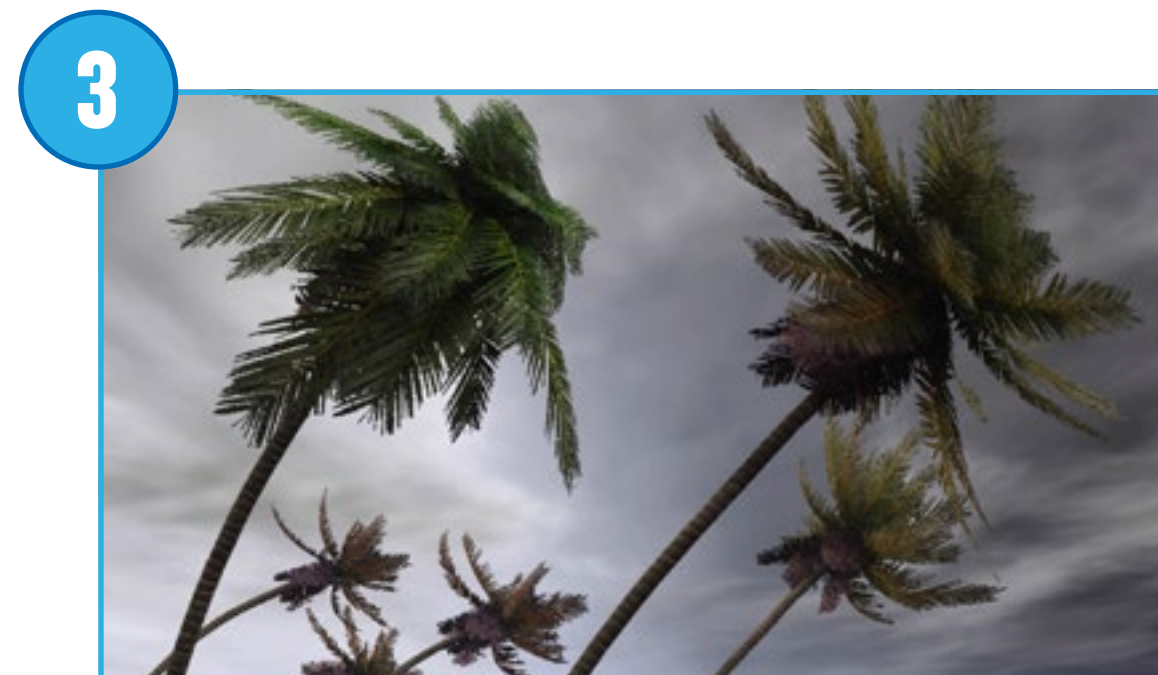
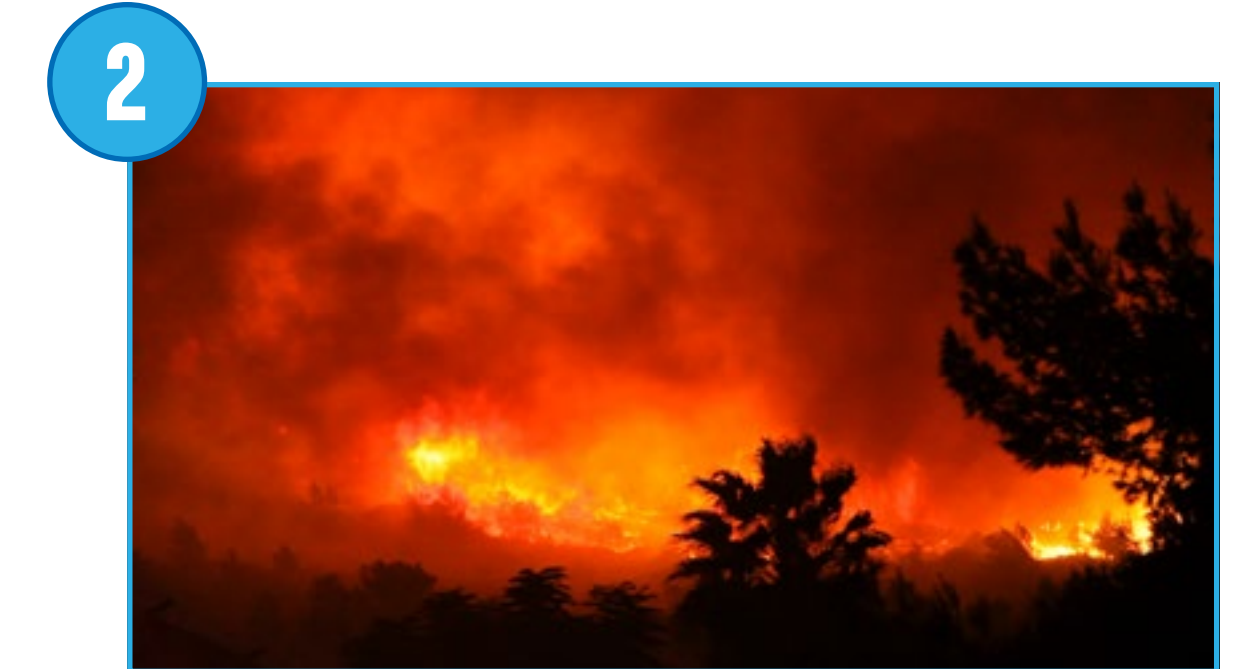
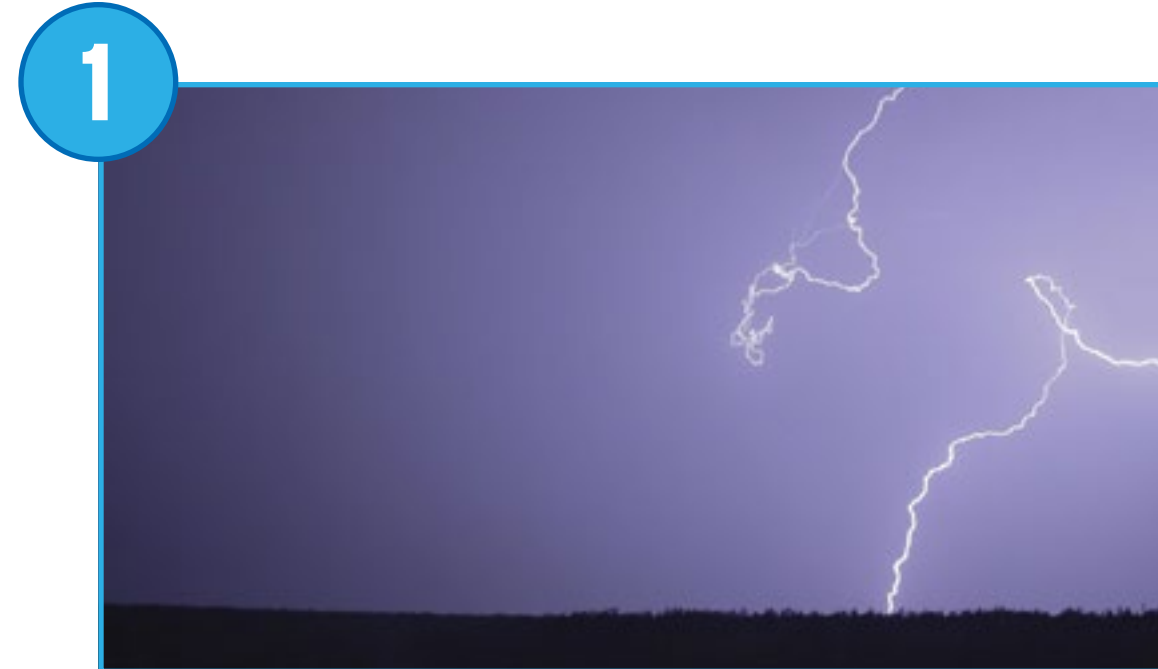



Explore phase

Questions for discussion

1. What kinds of weather-related hazards occur in your area or in other areas?
The answer to this question might include bushfires, floods, hurricanes, or tornadoes.
2. How do weather-related hazards affect animals or people?
The answer to this question will depend on the location.
3. Describe different ways in which a helicopter can be used during a weather-related hazard.
Helicopters can be used to airlift people and supplies, and to conduct aerial water drops on bushfires.

Ask your students to answer with text or pictures using the Documentation tool.



Create phase

Build and program a rescue helicopter

Students will follow the building instructions to create an exciting rescue helicopter.

1. Build a helicopter.

The model used in this project uses a pulley to transmit the movement from the motor axle to the string axle.

2. Program the helicopter to lower and raise its string.

When the first Start Block is pressed, the motor will run in one direction for two seconds. The motor will run in the opposite direction when the second Start Block is pressed.

▶ Suggestion

Before your students begin designing their solutions, ask them to adjust the parameters of the program so that they fully understand it.





Create phase

From this model, students should be able to design their own drop or rescue device.

Students have to modify the helicopter so it can be used in a weather-damaged area, making sure that their designs are safe, easy to use, and adapted to the situation. There is definitely more than one good answer to this challenge, but a good answer is something that can be linked to the criteria.

Ask the students to build at least two solutions for one of the cases, so that they can compare them.

1. Build a device to relocate an endangered animal.

Students can build a platform, a box, or a stretcher to lift the animal. They should make sure that the animal can not fall out during transportation.

2. Build a device that can drop materials to people in need.

Students can build a basket, a net, or a stretcher to lower materials. They should make sure that nothing can fall out under transportation.

3. Build a device that can drop water to put out a fire.

This modification could lead to a new design for the helicopter body, using the motor to drop water instead of moving the string.

▶ Important

It is important to note that the students' models will vary according to their individual choices, there are no building instructions or sample programs provided to students for this part of the project.

▶ Important

Ask the students to build two solutions for one of the cases listed above. Make sure that they compare their solutions according to the above listed criteria.



Create phase

Use the “Design further solutions” section of the student project as an optional extension. Keep in mind that these tasks are an extension of the “Use the model” section and are designed for older or more advanced students.

Design further solutions

In certain situations, helicopters might not be suitable for performing rescue missions. Describe a situation in which this might arise, and ask the students to think of alternative solutions to the problem. The situation could be:

- A rescue during a tornado.
- A rescue following an avalanche.
- Providing vital resources during a drought period.

Ask the students to reflect on what they learnt in the previous part of the project. Ask them to explain how their ability to find solutions to problems has improved.

Collaboration suggestion

Teams can work together to find solutions to situations that have multiple rescue aspects. For example, one team could focus on removing debris and the second team could focus on rescuing people or animals.



Share phase

Complete the document

Ask the students to document their projects in a variety of ways:

- Ask the students to take photographs of each version they create, to present what they consider to be their best solution, and to explain why.
- Ask your students to compare these images with real-life images.
- Ask your students to record project presentation videos.

Present results

In this project, ask the students to present two of their designs, and ask them to explain why these solutions meet the criteria or why not.

To enhance students' presentations:

- Ask them to describe how their solution is used in the rescue mission they have chosen.
- Ask them to add some context to their explanation.
- Ask them to describe where this is happening, in what conditions, and to identify any safety issues they needed to address.

Drop and Rescue

One possible way of sharing

Students in this class have designed a helicopter to deliver vital supplies and carry out rescue missions involving both people and animals.

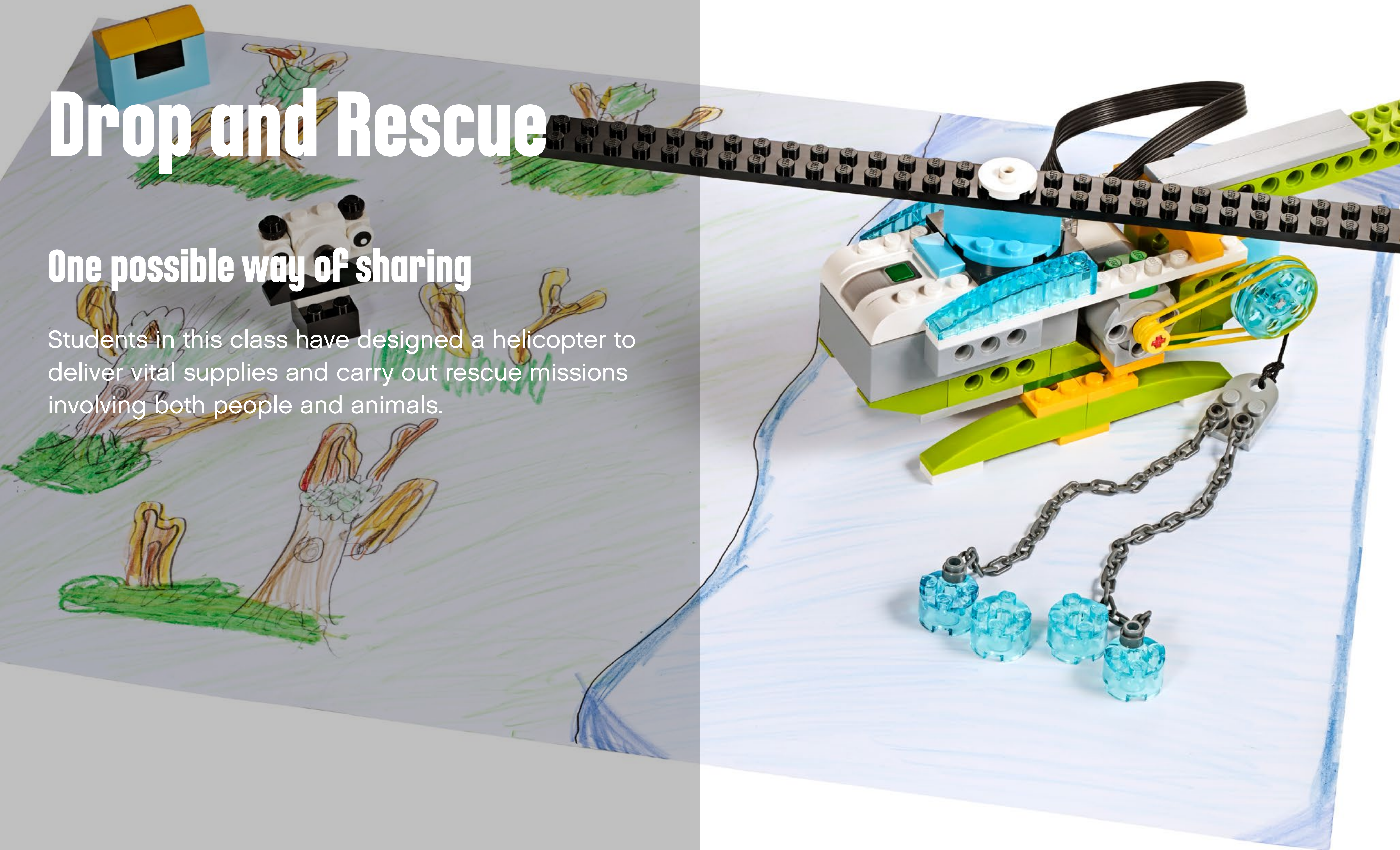



Project 8

Sort to Recycle

This project is about designing a device that uses the physical properties of objects, including their shape and size, to sort them.



Curriculum links

Australian Curriculum: Science

Science Understanding

ACSSU031: Different materials can be combined, including by mixing, for a particular purpose

ACSSU074: Natural and processed materials have a range of physical properties

Science as a Human Endeavour

ACSHE034: Science involves asking questions about, and describing changes in, objects and events

ACSHE035: People use science in their daily lives, including when caring for their environment

ACSHE062: Science knowledge helps people to understand the effect of their actions

Science Inquiry Skills

AC SIS037: Respond to and pose questions, and make predictions about familiar objects and events

AC SIS038: Participate in different types of guided investigations to explore and answer questions, such as manipulating materials, testing ideas, and accessing information sources

AC SIS216: Compare results with predictions, suggesting possible reasons for findings

AC SIS069: Reflect on the investigation; including whether a test was fair or not

AC SIS042: Represent and communicate observations and ideas in a variety of ways

AC SIS071: Represent and communicate ideas and findings in a variety of ways such as diagrams, physical representations, and simple reports





Curriculum links

Other Curriculum links

Australian Curriculum: Technologies Design and Technologies

Knowledge and Understanding

ACTDEK001: Identify how people design and produce familiar products, services, and environments, and consider sustainability to meet personal and local community needs

ACTDEK004: Explore the characteristics and properties of materials and components that are used to produce designed solutions

ACTDEK010: Recognise the role of people in design and technologies occupations and explore factors, including sustainability that impact on the design of products, services, and environments to meet community needs

ACTDEK013: Investigate the suitability of materials, systems, components, tools, and equipment for a range of purposes

ACTDEK019: Examine how people in design and technologies occupations address competing considerations, including sustainability in the design of products, services, and environments for current and future use

ACTDEK023: Investigate characteristics and properties of a range of materials, systems, components, tools, and equipment, and evaluate the impact of their use

Processes and Production Skills

ACTDEP008: Use personal preferences to evaluate the success of design ideas, processes, and solutions, including their care for environment

ACTDEP009: Sequence steps for making designed solutions and working collaboratively

ACTDEP014: Critique needs or opportunities for designing and explore and test a variety of materials, components, tools, and equipment, and the techniques needed to produce designed solutions

ACTDEP016: Select and use materials, components, tools, equipment, and techniques, and use safe work practices to make designed solutions

ACTDEP017: Evaluate design ideas, processes and solutions based on criteria for success developed with guidance and including care for the environment

ACTDEP024: Critique needs or opportunities for designing, and investigate materials, components, tools, equipment, and processes to achieve intended designed solutions

Digital Technologies

Knowledge and Understanding

ACTDIK001: Recognise and explore digital systems (hardware and software components) for a purpose

ACTDIK007: Identify and explore a range of digital systems with peripheral devices for different purposes, and transmit different types of data

ACTDIK014: Examine the main components of common digital systems and how they may connect together to form networks to transmit data

Processes and Production Skills

ACTDIP004: Follow, describe, and represent a sequence of steps and decisions (algorithms) needed to solve simple problems

ACTDIP011: Implement simple digital solutions as visual programs with algorithms involving branching (decisions) and user input

ACTDIP019: Design, modify, and follow simple algorithms involving sequences of steps, branching, and iteration (repetition)

ACTDIP020: Implement digital solutions as simple visual programs involving branching, iteration (repetition), and user input



Quick glance: Plan this WeDo 2.0 project

Preparation: 30 min.

- For information regarding general preparation, please see the “Classroom Management” chapter.
- Read about the project so you have a good idea of what to do.
- Define how you want to introduce this project: Use the video provided in the project in the WeDo 2.0 Software, or use material of your own choice.
- Determine the end result of this project: the parameters to present and produce the document.
- Make sure that timing allows for expectations to be met.

► Important

This project is a design brief. Please refer to the “WeDo 2.0 in Curriculum” chapter for further explanations of design practices.

Explore phase: 30-60 min.

- Start the project using the introductory video.
- Hold a group discussion.
- Allow the students to document their ideas for Max and Mia’s questions using the Documentation tool.

Create phase: 45-60 min.

- Ask the students to build the first model from the provided building instructions.
- Allow them to program the model using the sample program.
- Allow time for the students to create different ways of sorting the two objects.
- Consider asking your students to sketch their designs and modifications as part of this project.

Create more phase (optional): 45-60 min.

- You can use this extension of the project for differentiation or for older students.

Share phase: 45 min. or more

- Make sure that your students document their prototypes – what works and what doesn’t – and describe the design challenges they encounter.
- Encourage your students to share their experiences in different ways.
- Ask the students to present their projects.
- Ask the students to create their final science report.

► Suggestion

Have a look at the following Open Projects after this one:

- Cleaning the Oceans
- Extreme Habitats



Differentiation

To ensure success, consider giving more guidance on building and programming, such as:

- Allow more time for students to understand how the first prototype works.
- Allow them time to create more than one prototype.
- Explain engineering-based design.

Be specific about how you would like them to present and document their findings. For example, a team sharing session.

Design further solutions

For more experienced students, you may want to allocate extra time for building and programming to allow them to create different types of devices that sort according to other properties beyond shape. Ask them to use the design process to explain all of the versions they make.

Students' misconceptions

Students will often confuse weight, mass, and volume. They will make the correlation that the heavier an object is, the bigger it is. They will also fail to connect gravity to the content. Be sure to formulate equations in the areas of weight, mass, and volume.

Vocabulary

Physical property

The characteristic of an object that can be observed or measured without changing its chemical composition, such as appearance, smell, or height

Recycle

To convert waste items into usable materials

Sort

To arrange into groups by type

Efficient

Works in the best possible manner

Waste

Discarded material deemed no longer useful



Scientific understanding assessment rubrics

You can use these assessment rubrics with the observation rubrics grid, which you will find in the “Assess with WeDo 2.0” chapter.

Explore phase

During the Explore phase, make sure that each student is actively involved in the discussion, asks and answers questions, and can explain how the properties of an object help them to sort it.

1. The student is unable to provide adequate answers to questions, participate in discussions, or adequately describe the properties of the object and how it can be sorted.
2. The student is able, with prompting, to provide adequate answers to questions, participate in discussions, or with help, describe the properties of the object and how it can be sorted.
3. The student is able to provide adequate answers to questions and participate in class discussions, and can describe the properties of the object and how it can be sorted.
4. The student is able to extend on explanations in discussions and describe the properties of the object and how it can be sorted.

Create phase

During the Create phase, make sure that each student can work as part of a team, demonstrates the use of the engineering design process, and gathers and uses information to solve problems.

1. The student is unable to work as part of a team to solve problems and does not demonstrate the ability to use the engineering design process to solve problems.
2. The student is able to work as part of a team to solve problems, or with help can demonstrate the use of the engineering design process to gather and use information to solve problems.

3. The student is able to work as part of a team to solve problems, and can demonstrate the use of the engineering design process to gather and use information to solve problems.
4. The student works as a team leader, is able to extend the use of engineering design and can gather and use information to solve problems in many ways.

Share phase

During the Share phase, make sure that each student can explain how they solved the problem and that they communicate how they used the size of objects to sort them.

1. The student does not explain how he/she solved the problem and does not communicate how he/she sorted the objects by size.
2. The student can partially explain how he/she solved the problem and communicates, with prompting, some ideas on how he/she sorted objects by size.
3. The student can explain adequately how he/she solved the problem and communicates how he/she sorted objects by size.
4. The student can explain, in detail, how he/she solved the problem and communicates very clearly and thoroughly how he/she sorted objects by size.



Presentation and problem-solving assessment rubrics

You can use these assessment rubrics with the observation rubrics grid, which you will find in the “Assess with WeDo 2.0” chapter.

Explore phase

During the Explore phase, make sure that each student can effectively explain his/her own ideas and comprehension related to the questions posed.

1. The student is unable to share his/her ideas related to the questions posed during the Explore phase.
2. The student is able, with prompting, to share his/her ideas related to the questions posed during the Explore phase.
3. The student adequately expresses his/her ideas related to the questions posed during the Explore phase.
4. The student uses details to extend explanations of his/her ideas related to the questions posed during the Explore phase.

Create phase

During the Create phase, make sure that each student makes appropriate choices (i.e., screenshot, image, video, text) and follows the established expectations for documenting their findings.

1. The student fails to document findings throughout the investigation.
2. The student documents his/her findings, but the documentation is incomplete or does not comply with all of the established expectations.
3. The student adequately documents findings for each part of the investigation and makes appropriate choices and selections.
4. The student uses a variety of appropriate methods for documentation and exceeds the established expectations.

Share phase

During the Share phase, make sure that each student uses the evidence that they gathered during their investigations to justify their reasoning, and that they adhere to established guidelines when presenting their findings to an audience.

1. The student does not use evidence from his/her findings when sharing ideas during the presentation. The student does not follow the established guidelines.
2. The student uses some evidence from his/her findings, but the justification is limited. In general, established guidelines are followed, but may be lacking in one or more areas.
3. The student adequately provides evidence to justify his/her findings and follows established guidelines for presenting.
4. The student fully discusses his/her findings and thoroughly utilises appropriate evidence to justify his/her reasoning, while following all established guidelines.



Explore phase

The introductory video may set the stage for the following ideas to be reviewed and discussed with students for this project.

Introductory video

Recycling material is one of the biggest challenges of the 21st century. Recycling can give a second life to the waste materials. Encouraging more people to consistently recycle their waste is a challenge. One way to encourage more widespread recycling is to increase the efficiency of sorting methods:

1. People must adopt behaviour that leads to a reduction in the disposal of waste.
2. Recyclable materials should be sorted at the beginning of the recycling process, instead of being mixed together and sent to recycling centres.
3. People or machines can separate waste according to its kind: paper, plastic, metal, or glass.
4. When a machine is used to sort objects, it needs to use one of the object's physical characteristics, such as weight, size, shape, or even its magnetic properties.

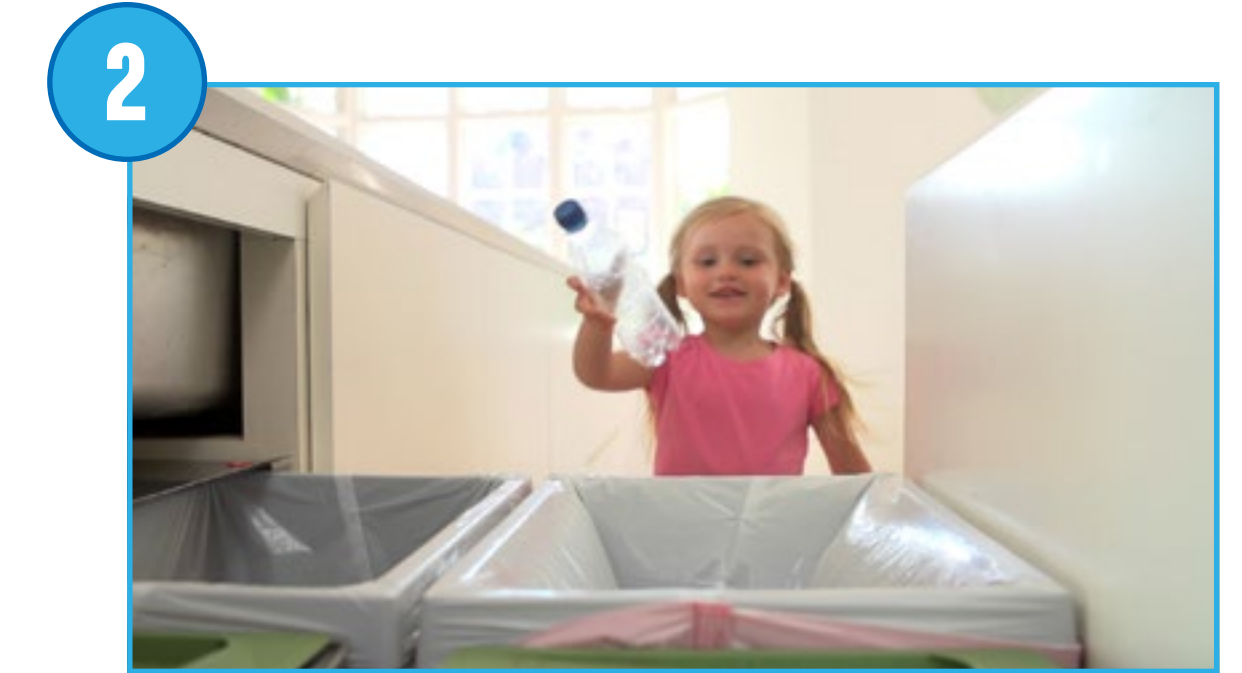
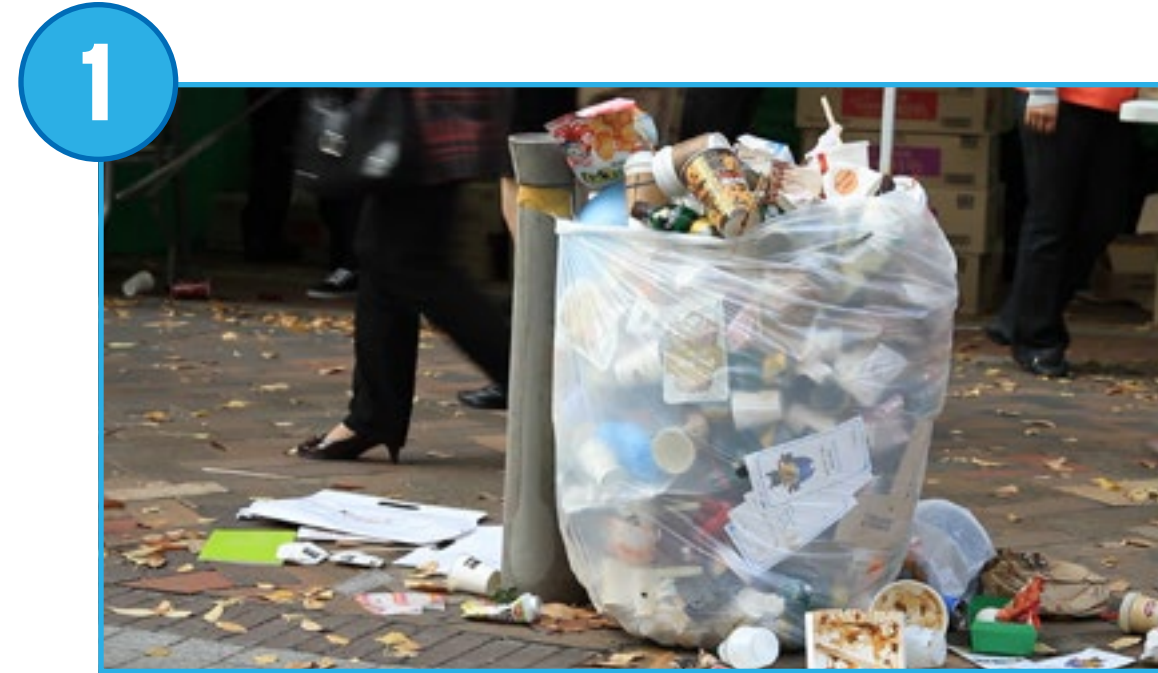



Explore phase

Questions for discussion

1. What does it mean to recycle?

Recycling is a process for converting waste materials into something new.
Commonly recycled items include paper, plastic, and glass.

2. How are recyclable materials sorted in your area?

Discuss whether the materials are sorted by hand or machine, together with your students. Ask the students if they sort waste items for recycling at home.

3. Imagine a device that can sort waste according to its shape.

The answer to this question will guide students to the design process.

Ask your students to answer with text or pictures using the Documentation tool.

Other questions to explore

1. Where does your recycling material go to?

The answer to this question will be different according to your location, but most likely, materials will go to the local recycling facility. Non-recyclable material will go to a different location, such as a landfill or an incinerator.



Create phase

Build and program a truck to sort recyclable objects

Students will follow the building instructions to create a sorting truck and the recyclable objects.

1. Build a sorting truck.

The model used in this project uses a pulley system to flip the truck load on an axis. At first, both parts should be able to pass through, even though they are different shapes. Later, students will be challenged to modify the design so that the objects are sorted by size.

2. Program the truck load.

This program will turn the motor on in one direction for one second to make sure that the load is at its reset position. It will wait three seconds for the boxes to be loaded by the student, play an engine sound, and then flip the load to drop the boxes.

► Important

Students may have to adjust the power level of the motor in order for this program to work. The power efficiency of the motors can vary.

► Suggestion

Before your students begin their investigations, ask them to adjust the parameters of the program so that they fully understand it.





Create phase

Design another solution

From this model, students should be able to change the design of the truck load to sort the boxes into two different groups according to their shape. Allow the students a lot of flexibility. There are simple and more complex solutions to this problem that may involve changes to the design of the sorter, the program, or a combination of both.

Solution ideas

1. Modify the truck to sort the boxes.

By removing the LEGO® back plate of the truck, one box should be able to fall into the first hole while the other box slides off the back, due to its shape. Other designs may work just as well.

2. Use the Motion Sensor to sort.

By placing the Motion Sensor on the side of the load in the proper position and by creating the right program, the sensor can detect objects based on size.

3. Sort the boxes outside the truck.

This solution would require building something else in addition to, or instead of, the truck. The boxes can be delivered to the factory and sorted in another way.

▶ Important

It is important to note that students' models will vary according to their individual choices, there are no building instructions or sample programs provided to students for this part of the project.

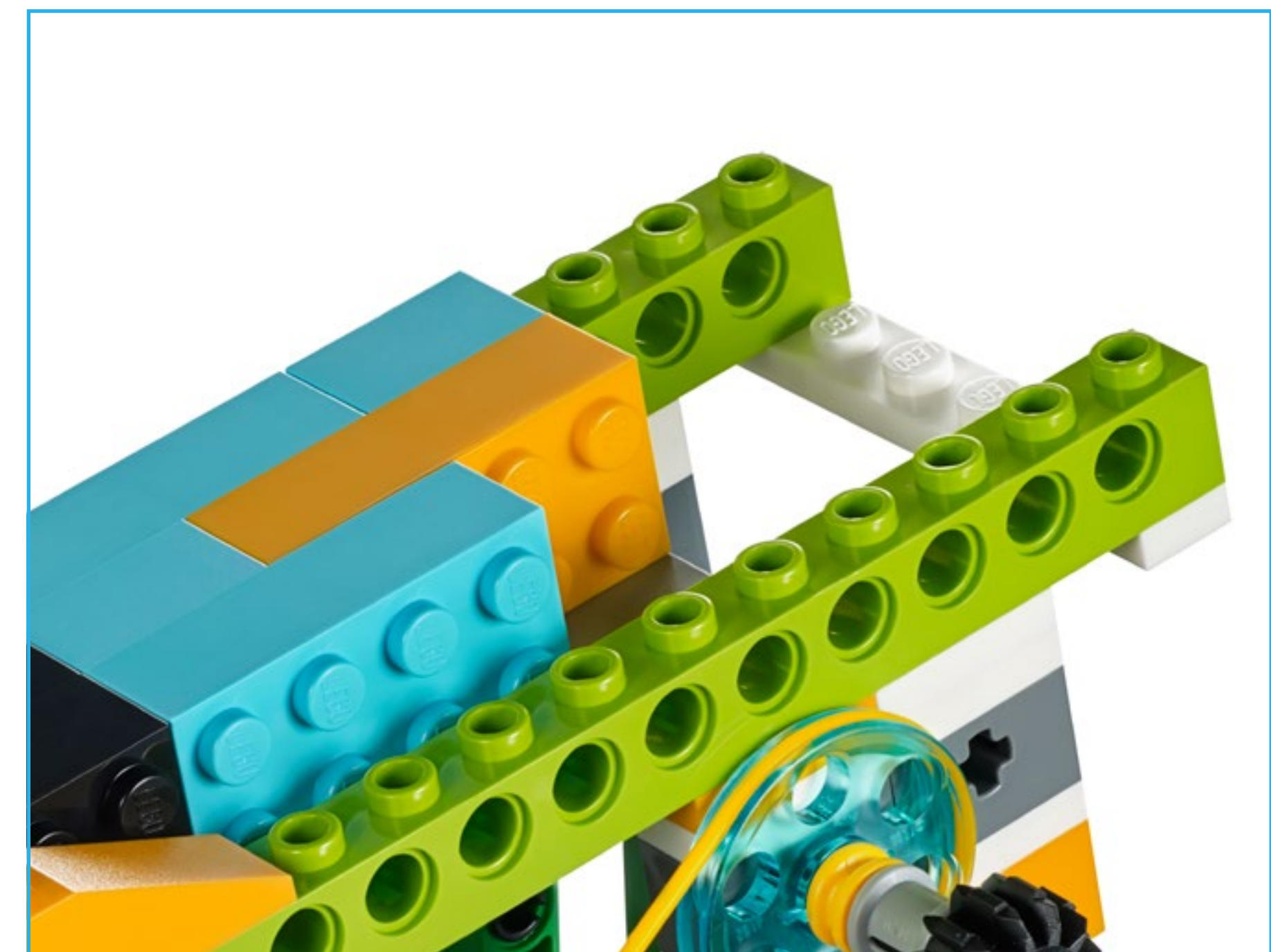
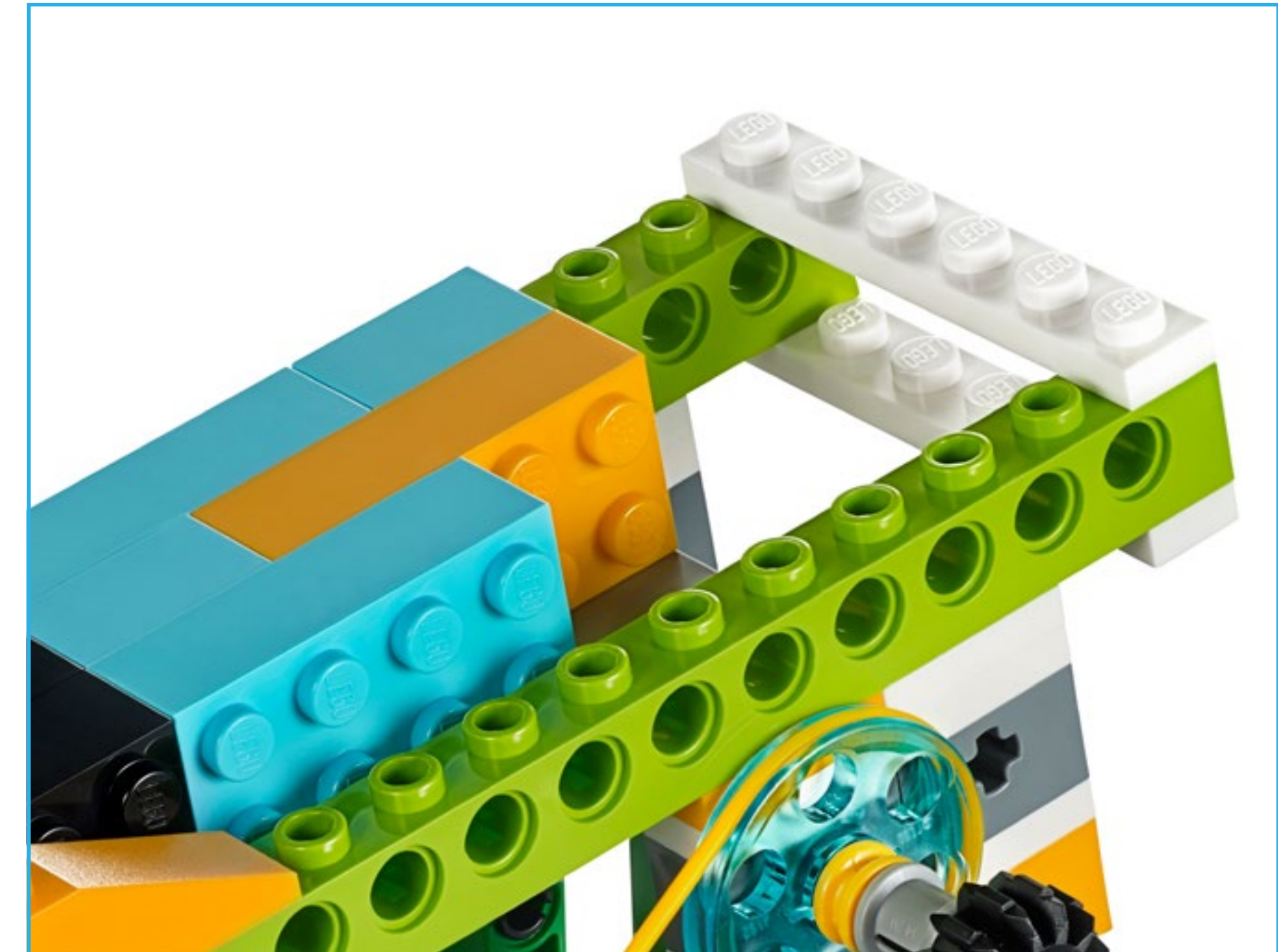



Create phase

Use the “Design further solutions” section of the student project as an optional extension. Keep in mind that these tasks are an extension of the “Use the model” section and are designed for older or more advanced students.

The next step to this design project could be to ask students to design a solution for a more complex problem.

Design further solutions

Ask students to design a third object to sort. In order to sort items, students will probably have to move away from the truck model and design another type of device:

1. Sort the objects using a conveyor belt.
2. Sort the objects using a robot arm.
3. Sort the objects using two different devices.

Note, it is not essential that the device works perfectly, or that the students find a successful solution. It is more important that the reasoning behind the sorting principles are well articulated as students apply principles of engineering design.

Collaboration suggestion

If you group teams together, students will get more options to create sorting strategies. You could ask one team to sort the objects and then ask the second team to sort them further. For example, the first team could sort small objects from the medium and large ones. The second team would then sort the medium from the large.



Share phase

Complete the document

Ask the students to document their project in several ways:

- Ask the students to take photographs of each version they create and ask them to explain the most successful solution or the one with the most potential.
- Ask the teams of students to compare and contrast their designs with each other.
- Ask the students to document how the objects could be sorted by shape, and how the shape of each object was important to the solution.

Present results

Students should describe how their solutions sorts objects according to their shape.

To enhance students' presentations:

- Ask the students to present how they worked toward solving this problem.
- Ask them to explain the challenges they encountered and how they worked to modify their designs and programs as a result.
- Ask them to describe the context around their explanation.
- Discuss if this solution could be applied in real life.

Sort to Recycle

One possible way of sharing

Students in this class have designed different ways of sorting objects according to their shapes.

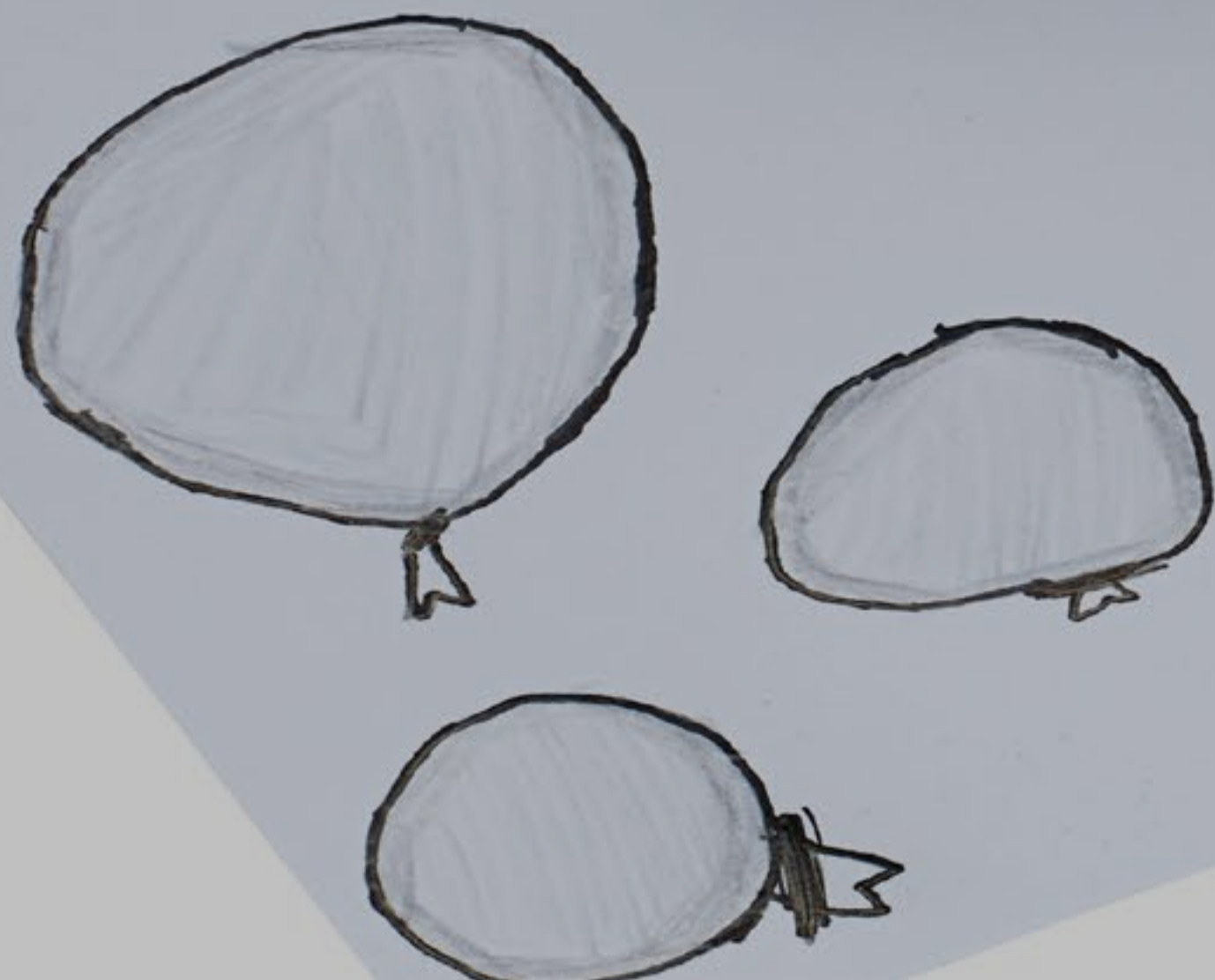

Open Projects overview

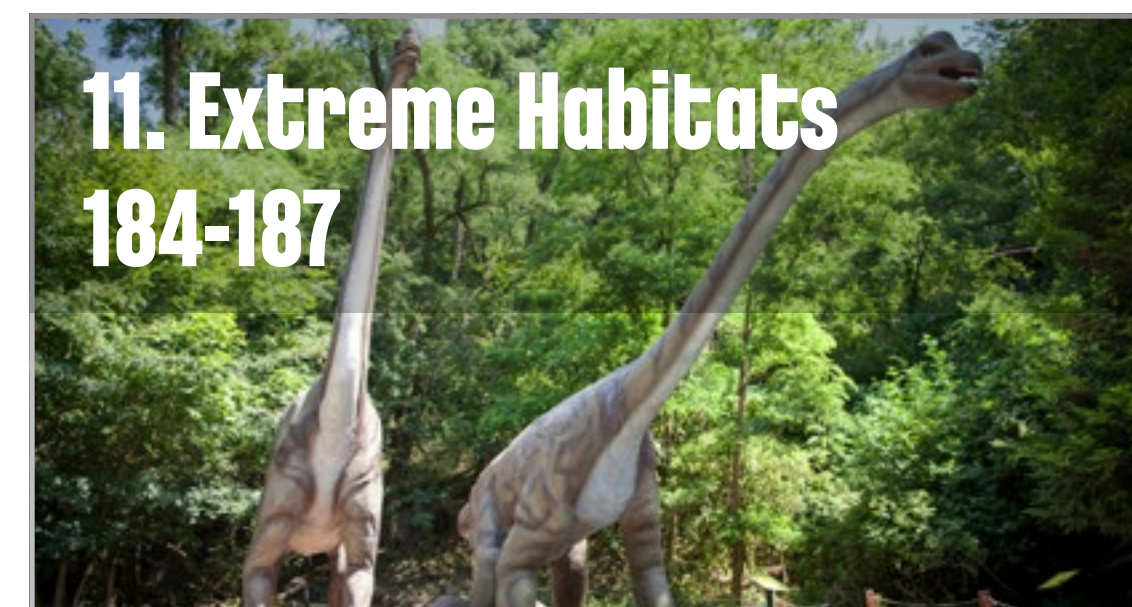

Project 9

Predator and Prey

This project is about modelling a LEGO® representation of the behaviour of predators and their prey.





Curriculum links

Australian Curriculum: Science

Science Understanding

ACSSU073: Living things depend on each other and the environment to survive

Science as a Human Endeavour

ACSHE061: Science involves making predictions and describing patterns and relationships

Science Inquiry Skills

AC SIS065: With guidance, plan and conduct scientific investigations to find answers to questions, considering the safe use of appropriate materials and equipment

AC SIS216: Compare results with predictions, suggesting possible reasons for findings

AC SIS069: Reflect on the investigation; including whether a test was fair or not

AC SIS071: Represent and communicate observations, ideas, and findings using formal and informal representations

Other Curriculum links

Australian Curriculum: Technologies Design and Technologies

Knowledge and Understanding

ACTDEK002: Explore how technologies use forces to create movement in products

ACTDEK020: Investigate how electrical energy can control movement, sound, or light in a designed product or system

Processes and Production Skills

ACTDEP007: Use materials, components, tools, equipment, and techniques to safely make designed solutions

ACTDEP024: Critique needs or opportunities for designing, and investigate materials, components, tools, equipment, and processes to achieve intended designed solutions

Digital Technologies

Knowledge and Understanding

ACTDIK001: Recognise and explore digital systems (hardware and software components) for a purpose

ACTDIK007: Identify and explore a range of digital systems with peripheral devices for different purposes, and transmit different types of data

ACTDIK014: Examine the main components of common digital systems and how they may connect together to form networks to transmit data



Curriculum links

Processes and Production Skills

ACTDIP004: Follow, describe, and represent a sequence of steps and decisions (algorithms) needed to solve simple problems

ACTDIP010: Define simple problems, and describe and follow a sequence of steps and decisions (algorithms) needed to solve them

ACTDIP011: Implement simple digital solutions as visual programs with algorithms involving branching (decisions) and user input

ACTDIP019: Design, modify, and follow simple algorithms involving sequences of steps, branching, and iteration (repetition)

ACTDIP020: Implement digital solutions as simple visual programs involving branching, iteration (repetition), and user input

Explore phase

Predators share fascinating dynamic relationships with their prey. They have evolved over centuries to improve as hunters and trappers. This has forced prey to adapt in order to evade predators and survive.

Let students explore the developing relationships between different sets of predators and their prey.



Create phase

Students create a predator or prey model in order to describe the relationship between a predator and its prey.

Let students explore the Design Library so they can choose a model for inspiration. Then allow them to experiment and create their own solutions, modifying any basic model as they see fit.

Suggested Design Library base models include:

- Walk
- Grab
- Push

▶ Suggestion

Divide the students into two teams. Ask one team to create a predator and the other team to create the prey.

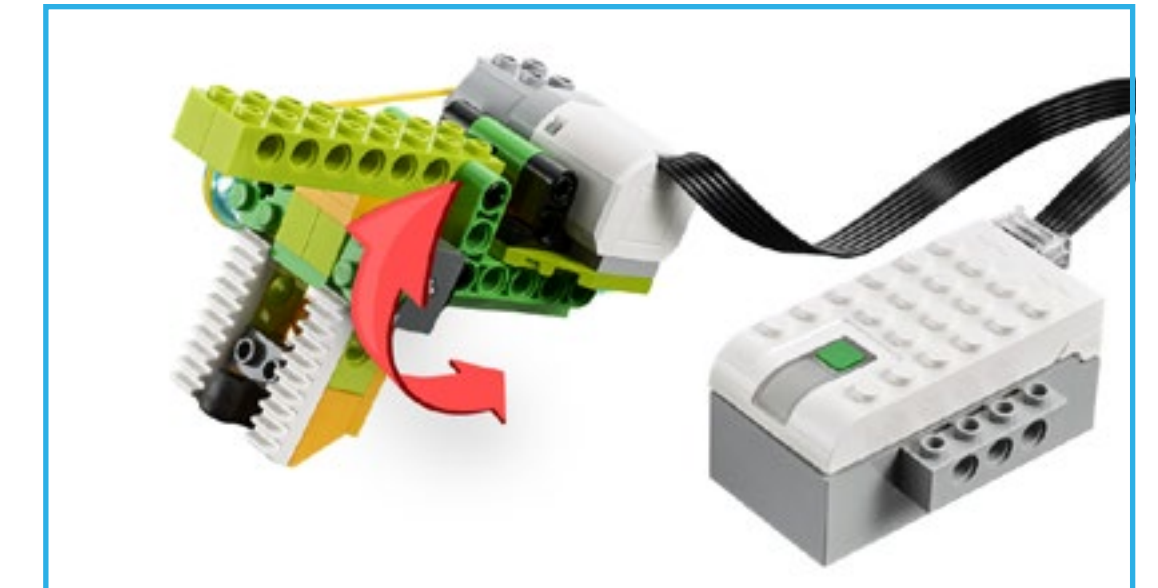
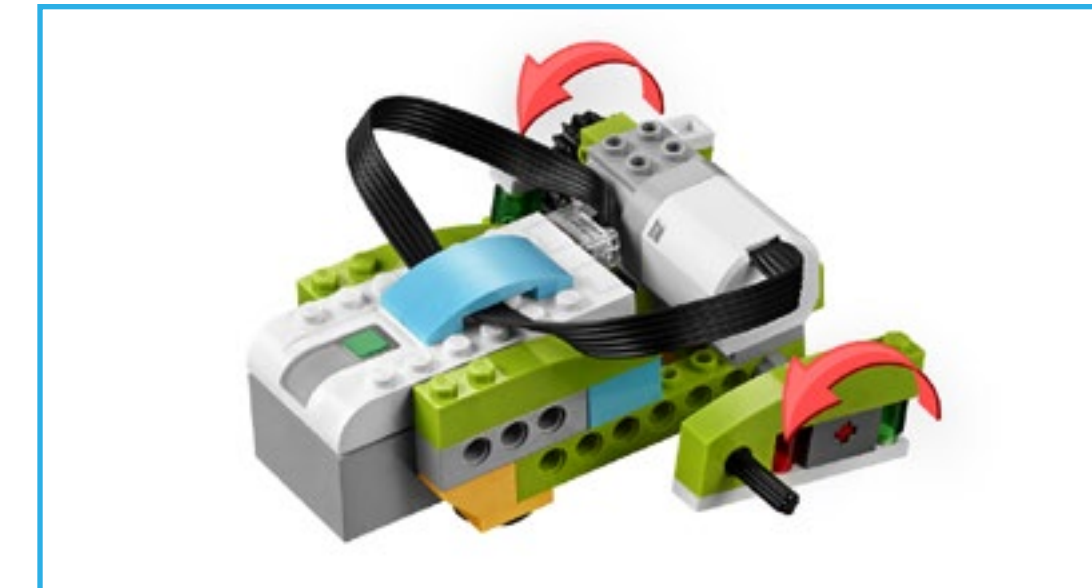

Share phase

Students should present their predator or prey models, explaining how they have represented the relationship between two species. They can use research and portfolio documentation to support their explorations and ideas.

Assessment

Ensure that students explain the different strategies the chosen predator uses to attract and catch its prey.

Project 10

Animal Expression

This project is about modelling a LEGO® representation of the various communication methods used in the animal kingdom.





Curriculum links

Australian Curriculum: Science

Science Understanding

ACSSU044: Living things can be grouped on the basis of observable features and can be distinguished from non-living things

Science as a Human Endeavour

ACSHE050: Science involves making predictions and describing patterns and relationships

Science Inquiry Skills

AC SIS053: With guidance, identify questions in familiar contexts that can be investigated scientifically and make predictions based on prior knowledge

AC SIS215: Compare results with predictions, suggesting possible reasons for findings

AC SIS058: Reflect on the investigation, including whether a test was fair or not

AC SIS060: Represent and communicate observations, ideas and findings using formal and informal representations

Other Curriculum links

Australian Curriculum: Technologies Design and Technologies

Knowledge and Understanding

ACTDEK002: Explore how technologies use forces to create movement in products

ACTDEK020: Investigate how electrical energy can control movement, sound or light in a designed product or system

Processes and Production Skills

ACTDEP007: Use materials, components, tools, equipment, and techniques to safely make designed solutions

ACTDEP024: Critique needs or opportunities for designing, and investigate materials, components, tools, equipment, and processes to achieve intended designed solutions

Digital Technologies

Knowledge and Understanding

ACTDIK001: Recognise and explore digital systems (hardware and software components) for a purpose

ACTDIK007: Identify and explore a range of digital systems with peripheral devices for different purposes, and transmit different types of data

ACTDIK014: Examine the main components of common digital systems and how they may connect together to form networks to transmit data



Curriculum links

Processes and Production Skills

ACTDIP004: Follow, describe, and represent a sequence of steps and decisions (algorithms) needed to solve simple problems

ACTDIP010: Define simple problems, and describe and follow a sequence of steps and decisions (algorithms) needed to solve them

ACTDIP011: Implement simple digital solutions as visual programs with algorithms involving branching (decisions) and user input

ACTDIP019: Design, modify, and follow simple algorithms involving sequences of steps, branching, and iteration (repetition)

ACTDIP020: Implement digital solutions as simple visual programs involving branching, iteration (repetition), and user input

Explore phase

Bioluminescence is the biochemical emission of light by living organisms, such as fireflies, shrimp, and certain types of deep-sea fish. Bioluminescent creatures use their glowing ability to camouflage themselves, lure prey, and communicate. Most other animals communicate through sound and movement.

Let the students explore different kinds of social interaction between species to determine how communication helps them to find mates, reproduce, and survive.



Create phase

Students create a creature and illustrate its method of communication. The model should display one specific type of social interaction, such as light, movement, or sound.

Let students explore the Design Library so they can choose a model for inspiration. Then allow them to experiment and create their own solutions, modifying any basic model as they see fit.

Suggested Design Library models include:

- Tilt
- Wobble
- Walk

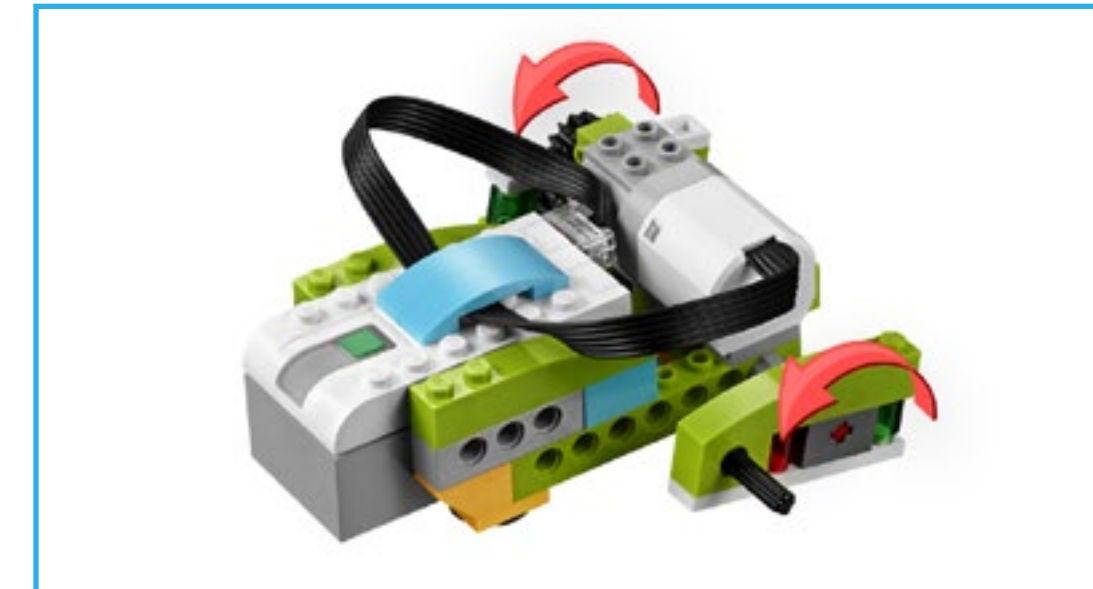

Share phase

Students should present their models, explaining how they represent a method of communication. They can use research and portfolio documentation to support their explorations and ideas.

Assessment

Ensure that students explain how the chosen method of communication creates social interaction. Ask them to explain why the animals interact in this way. Some research about the social interaction of animals might be necessary.

Project 11

Extreme Habitats

This project is about modelling a LEGO® representation of the influence of habitat on the survival of some species.





Curriculum links

Australian Curriculum: Science

Science Understanding

ACSSU043: Living things have structural features and adaptations that help them to survive in their environment

Science Inquiry Skills

AC SIS091: Reflect on and suggest improvements to scientific investigations

AC SIS093: Communicate ideas, explanations, and processes using scientific representations in a variety of ways, including multi-modal texts

Other Curriculum links

Australian Curriculum: Technologies Design Technologies

Knowledge and Understanding

ACTDEK002: Explore how technologies use forces to create movement in products

ACTDEK020: Investigate how electrical energy can control movement, sound, or light in a designed product or system

Processes and Production Skills

ACTDEP007: Use materials, components, tools, equipment, and techniques to safely make designed solutions

ACTDEP009: Sequence steps for making designed solutions and working collaboratively

ACTDEP024: Critique needs or opportunities for designing, and investigate materials, components, tools, equipment, and processes to achieve intended designed solutions

Digital Technologies

Knowledge and Understanding

ACTDIK001: Recognise and explore digital systems (hardware and software components) for a purpose

ACTDIK007: Identify and explore a range of digital systems with peripheral devices for different purposes, and transmit different types of data

ACTDIK014: Examine the main components of common digital systems and how they may connect together to form networks to transmit data



Curriculum links

Processes and Production Skills

ACTDIP004: Follow, describe, and represent a sequence of steps and decisions (algorithms) needed to solve simple problems

ACTDIP010: Define simple problems, and describe and follow a sequence of steps and decisions (algorithms) needed to solve them

ACTDIP011: Implement simple digital solutions as visual programs with algorithms involving branching (decisions) and user input

ACTDIP019: Design, modify, and follow simple algorithms involving sequences of steps, branching, and iteration (repetition)

ACTDIP020: Implement digital solutions as simple visual programs involving branching, iteration (repetition), and user input

Explore phase

Fossils reveal a lot about why animals were able to survive in their surroundings. Habitat, climate, food, shelter, and available resources all contribute to the success of a species.

Let students explore both carnivores and herbivores and what their fossils tell us about how they lived. They could consider how some species evolved to survive into the modern era. For example, ask the students to build a flying or a climbing dinosaur that nests in the treetops to protect its eggs, or a crocodile to show how it uses its body, tail, and jaws in combination with its water habitat.

Alternatively, students could look at extreme habitats or even fictional habitats, as long as they are able to make the link between the habitat and their creature.



Create phase

Students create both a creature and the habitat it lives in, showing how the creature has adapted to its surroundings.

Let students explore the Design Library so they can choose a model for inspiration. Then allow them to experiment and create their own solutions, modifying any basic model as they see fit.

Suggested Design Library models include:

- Crank
- Flex
- Reel

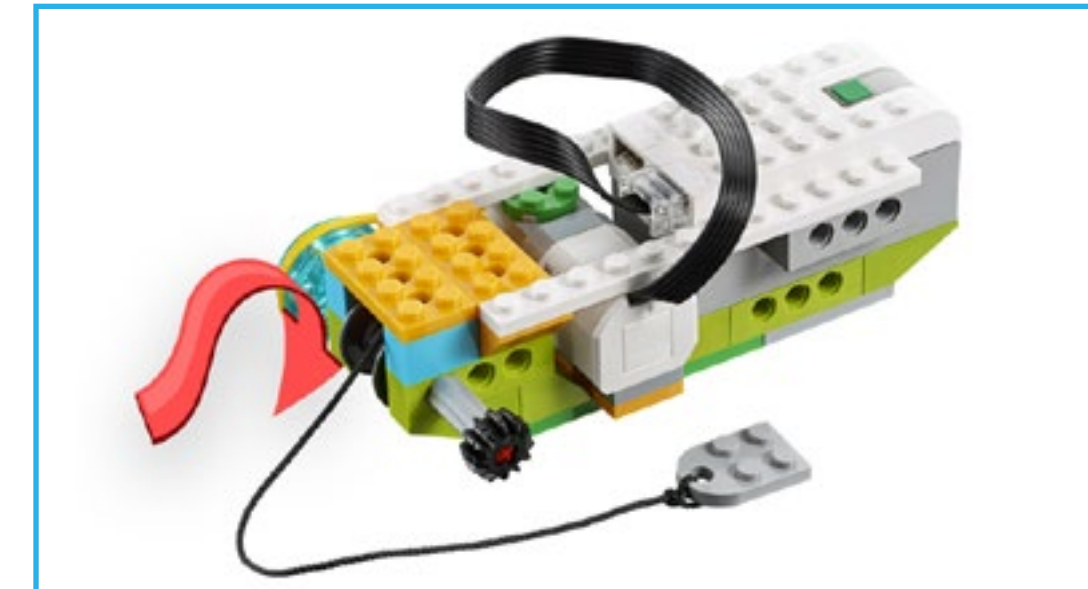
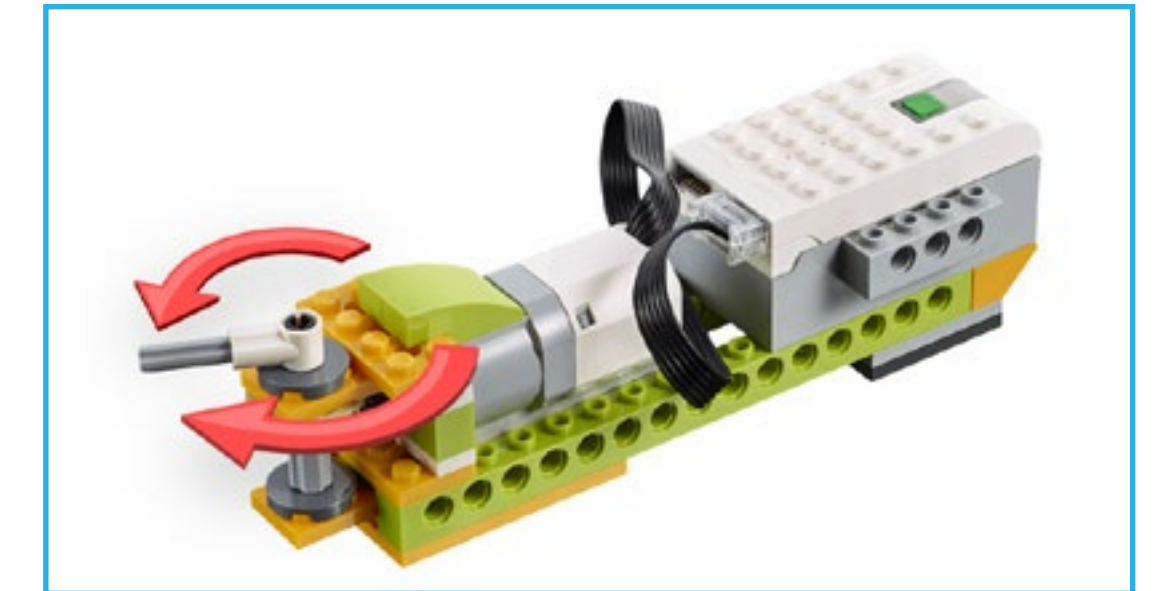

Share phase

Students should present their models, explaining the representation of the effect the habitat has on the creature. They can use research and portfolio documentation to support their explorations and ideas.

Assessment

Ensure that students explain the adaptations and unique characteristics that allow the creature to develop and survive.

Project 12

Space Exploration

This project is about designing a LEGO® prototype of a rover that would be ideal for exploring distant planets.





Curriculum links

Australian Curriculum: Science

Science Understanding

ACSSU078: The Earth is part of a system of planets orbiting around a star (the sun)

Science as a Human Endeavour

ACSHE081: Science involves testing predictions by gathering data and using evidence to develop explanations of events and phenomena and reflects historical and cultural contributions

ACSHE083: Scientific knowledge is used to solve problems and inform personal and community decisions

Science Inquiry Skills

AC SIS231: With guidance, pose clarifying questions and make predictions about scientific investigations

AC SIS086: Identify, plan, and apply the elements of scientific investigations to answer questions and solve problems using equipment and materials safely and identifying potential risks

AC SIS091: Reflect on and suggest improvements to scientific investigations

AC SIS093: Communicate ideas, explanations, and processes using scientific representations in a variety of ways, including multi-modal texts

Other Curriculum links

Australian Curriculum: Technologies Design and Technologies

Knowledge and Understanding

ACTDEK002: Explore how technologies use forces to create movement in products

ACTDEK004: Explore the characteristics and properties of materials and components that are used to produce designed solutions

ACTDEK013: Investigate the suitability of materials, systems, components, tools, and equipment for a range of purposes

ACTDEK019: Examine how people in design and technologies occupations address competing considerations, including sustainability in the design of products, services, and environments for current and future use

ACTDEK020: Investigate how electrical energy can control movement, sound, or light in a designed product or system

ACTDEK023: Investigate characteristics and properties of a range of materials, systems, components, tools, and equipment, and evaluate the impact of their use

Processes and Production Skills

ACTDEP005: Explore needs or opportunities for designing, and the technologies needed to realise designed solutions

ACTDEP006: Generate, develop, and record design ideas through describing, drawing and modeling

ACTDEP007: Use materials, components, tools, equipment, and techniques to safely make designed solutions

ACTDEP008: Use personal preferences to evaluate the success of design ideas, processes, and solutions, including their care for environment

ACTDEP014: Critique needs or opportunities for designing and explore and test a variety of materials, components, tools, and equipment, and the techniques needed to produce designed solutions



Curriculum links

ACTDEP015: Generate, develop, and communicate design ideas and decisions using appropriate technical terms and graphical representation techniques

ACTDEP016: Select and use materials, components, tools, equipment, and techniques, and use safe work practices to make designed solutions

ACTDEP017: Evaluate design ideas, processes, and solutions based on criteria for success developed with guidance and including care for the environment

ACTDEP024: Critique needs or opportunities for designing, and investigate materials, components, tools, equipment, and processes to achieve intended designed solutions

ACTDEP025: Generate, develop, and communicate design ideas and processes for audiences using appropriate technical terms and graphical representation techniques

ACTDEP026: Select appropriate materials, components, tools, equipment, and techniques, and apply safe procedures to make designed solutions

Digital Technologies

Knowledge and Understanding

ACTDIK001: Recognise and explore digital systems (hardware and software components) for a purpose

ACTDIK007: Identify and explore a range of digital systems with peripheral devices for different purposes, and transmit different types of data

ACTDIK014: Examine the main components of common digital systems and how they may connect together to form networks to transmit data

Processes and Production Skills

ACTDIP004: Follow, describe, and represent a sequence of steps and decisions (algorithms) needed to solve simple problems

ACTDIP010: Define simple problems, and describe and follow a sequence of steps and decisions (algorithms) needed to solve them

ACTDIP011: Implement simple digital solutions as visual programs with algorithms involving branching (decisions) and user input

ACTDIP019: Design, modify, and follow simple algorithms involving sequences of steps, branching, and iteration (repetition)

ACTDIP020: Implement digital solutions as simple visual programs involving branching, iteration (repetition), and user input

Explore phase

A rover is an automated motor vehicle that propels itself across the surface of a celestial body. A rover may examine territory and interesting features, analyse weather conditions, or even test materials such as soil and water.

Let the students explore rovers and discover their many interesting features and functions. Students should design various functions for their rover prototypes.



Create phase

Students design, build, and test a rover that can achieve one of the following missions when sent to another planet:

- Move in and out of a crater.
- Collect a rock sample.
- Drill a hole in the ground.

Let students explore the Design Library so they can choose a model for inspiration. Then allow them to experiment and create their own solutions, modifying any basic model as they see fit.

Suggested Design Library models are:

- Drive
- Grab
- Sweep

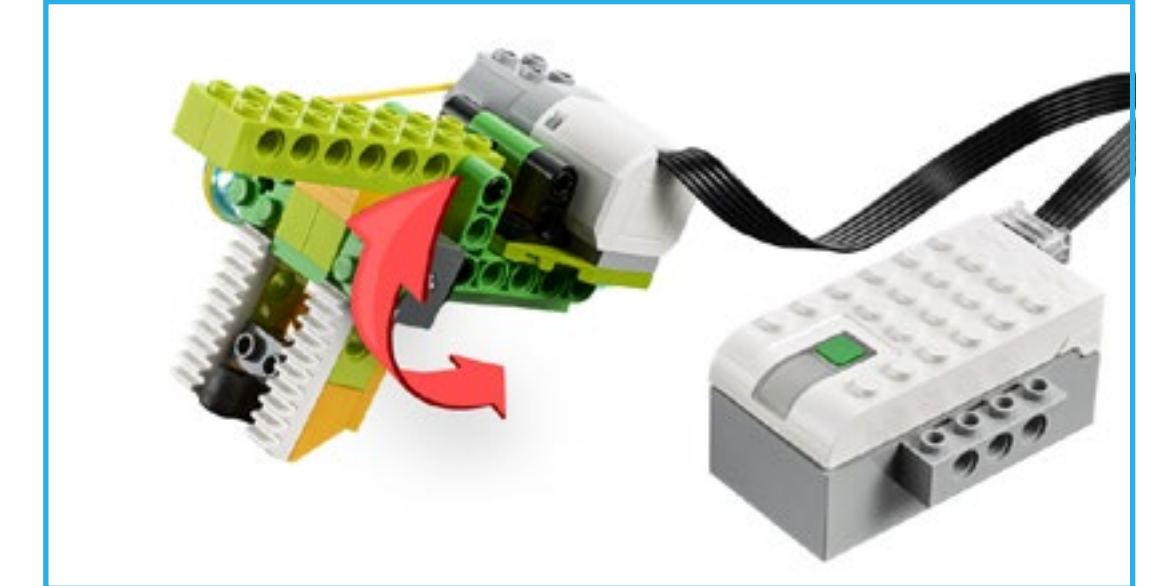

Share phase

Students should present their models, explaining how they have designed and tested their rover to complete a series of planetary exploration-based tasks. Ask the students to compare models and provide feedback to each other on how well the models fit the constraints and meet the criteria of the given problem.

Assessment

Ensure that students explain why each function is important and how they have allowed for the rover to move over fluctuating terrain to complete the assigned or chosen task.

Project 13

Hazard Alarm

This project is about designing a LEGO® prototype of a weather alarm device to alert people and reduce the impact of severe storms.





Curriculum links

Australian Curriculum: Science

Science Understanding

ACSSU096: Sudden geological changes or extreme weather conditions can affect Earth's surface

Science as a Human Endeavour

ACSHE098: Science involves testing predictions by gathering data and using evidence to develop explanations of events and phenomena and reflects historical and cultural contributions

ACSHE100: Scientific knowledge is used to solve problems and inform personal and community decisions

Science Inquiry Skills

AC SIS103: Identify, plan, and apply the elements of scientific investigations to answer questions and solve problems using equipment and materials safely and identifying potential risks

AC SIS221: Compare data with predictions and use as evidence in developing explanations

AC SIS108: Reflect on and suggest improvements to scientific investigations

AC SIS110: Communicate ideas, explanations, and processes using scientific representations in a variety of ways, including multimodal texts

Other Curriculum links

Australian Curriculum: Technologies Design and Technologies

Knowledge and Understanding

ACTDEK001: Identify how people design and products, services, and environments, and consider sustainability to meet personal and local community needs

ACTDEK004: Explore the characteristics and properties of materials and components that are used to produce designed solutions

ACTDEK010: Recognise the role of people in design and technologies occupations and explore factors, including sustainability that impact on the design of products, services and environments to meet community needs

ACTDEK013: Investigate the suitability of materials, systems, components, tools and equipment for a range of purposes

ACTDEK019: Examine how people in design and technologies occupations address competing considerations, including sustainability in the design of products, services, and environments for current and future use

ACTDEK020: Investigate how electrical energy can control movement, sound, or light in a designed product or system

ACTDEK023: Investigate characteristics and properties of a range of materials, systems, components, tools, and equipment, and evaluate the impact of their use

Processes and Production Skills

ACTDEP005: Explore needs or opportunities for designing, and the technologies needed to realise designed solutions

ACTDEP006: Generate, develop, and record design ideas through describing, drawing and modeling

ACTDEP007: Use materials, components, tools, equipment, and techniques to safely make designed solutions



Curriculum links

ACTDEP008: Use personal preferences to evaluate the success of design ideas, processes, and solutions, including their care for environment

ACTDEP009: Sequence steps for making designed solutions and working collaboratively

ACTDEP014: Critique needs or opportunities for designing and explore and test a variety of materials, components, tools, and equipment, and the techniques needed to produce designed solutions

ACTDEP015: Generate, develop, and communicate design ideas and decisions using appropriate technical terms and graphical representation techniques

ACTDEP016: Select and use materials, components, tools, equipment, and techniques, and use safe work practices to make designed solutions

ACTDEP017: Evaluate design ideas, processes, and solutions based on criteria for success developed with guidance and including care for the environment

ACTDEP024: Critique needs or opportunities for designing, and investigate materials, components, tools, equipment, and processes to achieve intended designed solutions

ACTDEP025: Generate, develop, and communicate design ideas and processes for audiences using appropriate technical terms and graphical representation techniques

ACTDEP026: Select appropriate materials, components, tools, equipment, and techniques, and apply safe procedures to make designed solutions

Digital Technologies

Knowledge and Understanding

ACTDIK001: Recognise and explore digital systems (hardware and software components) for a purpose

ACTDIK007: Identify and explore a range of digital systems with peripheral devices for different purposes, and transmit different types of data

ACTDIK014: Examine the main components of common digital systems and how they may connect together to form networks to transmit data

Processes and Production Skills

ACTDIP004: Follow, describe, and represent a sequence of steps and decisions (algorithms) needed to solve simple problems

ACTDIP010: Define simple problems, and describe and follow a sequence of steps and decisions (algorithms) needed to solve them

ACTDIP011: Implement simple digital solutions as visual programs with algorithms involving branching (decisions) and user input

ACTDIP012: Explain how student solutions and existing information systems meet common personal, school, or community needs

ACTDIP019: Design, modify, and follow simple algorithms involving sequences of steps, branching, and iteration (repetition)

ACTDIP020: Implement digital solutions as simple visual programs involving branching, iteration (repetition), and user input

ACTDIP021: Explain how student solutions and existing information systems are sustainable and meet current and future local community needs

Explore phase

The State Emergency Services issues timely forecasts for cyclones, bushfires and other natural hazards. Early warning systems for severe storms help save buildings, property, and lives.

Let students explore the equipment and alarm systems.



Create phase

Students design, build, and test an alarm device for wind, rain, fire, earthquake, or other natural/weather-related hazards. This could be done according to a set of criteria or with a more open outcome as determined by the teacher.

Let students explore the Design Library so they can choose a model for inspiration. Then allow them to experiment and create their own solutions, modifying any basic model as they see fit.

Suggested Design Library models are:

- Spin
- Revolve
- Motion

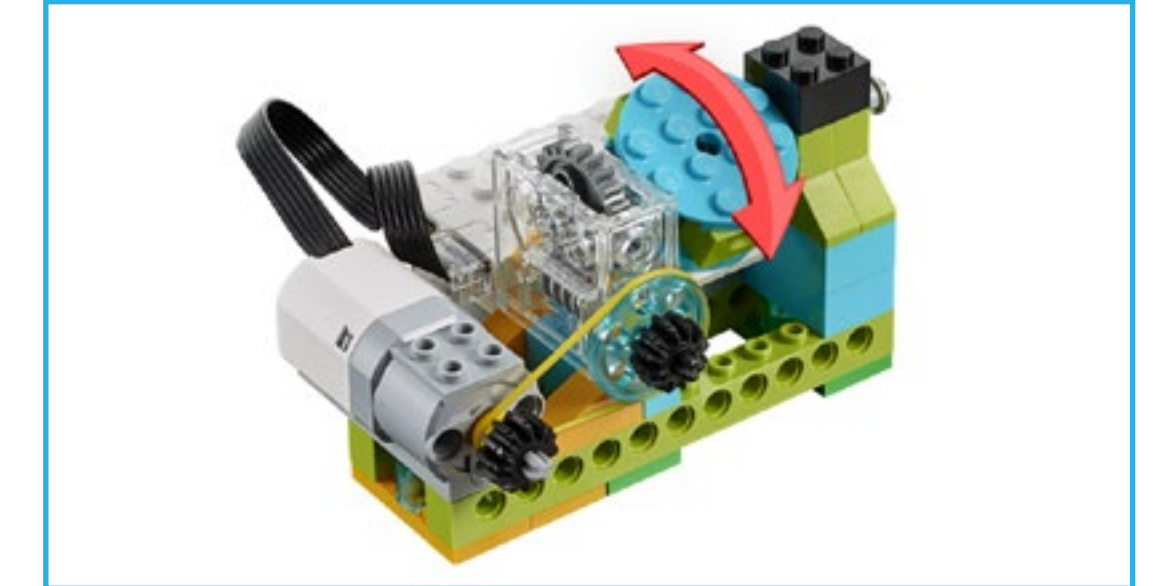
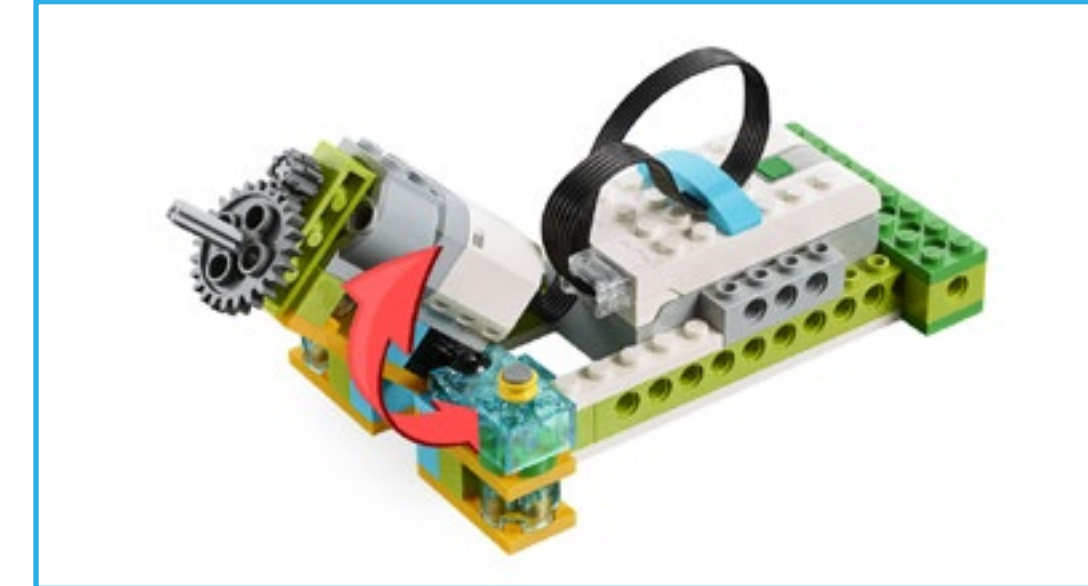

Share phase

Students should present their models, explaining how they designed and tested the hazard alarms. They can use research and portfolio documentation to support their explorations and ideas.

Assessment

Ensure that the students explain why the alarm is important, and how it has been designed and tested to help to reduce the impact of a specific hazard or to alert people of potential hazards.

Project 14

Cleaning the Ocean

This project is about designing a LEGO® prototype for a device that could help to remove plastic waste from the ocean.





Curriculum links

Australian Curriculum: Science

Science Understanding

ACSSU074: Natural and processed materials have a range of physical properties that can influence their use

Science as a Human Endeavour

ACSHE062: Science knowledge helps people to understand the effect of their actions

Science Inquiry Skills

AC SIS065: With guidance, plan, and conduct scientific investigations to find answers to questions, considering the safe use of appropriate materials and equipment

AC SIS069: Reflect on the investigation; including whether a test was fair or not

AC SIS071: Represent and communicate observations, ideas, and findings using formal and informal representations

Other Curriculum links

Australian Curriculum: Technologies Design and Technologies

Knowledge and Understanding

ACTDEK001: Identify how people design and products, services, and environments, and consider sustainability to meet personal and local community needs

ACTDEK004: Explore the characteristics and properties of materials and components that are used to produce designed solutions

ACTDEK010: Recognise the role of people in design and technologies occupations and explore factors, including sustainability that impact on the design of products, services, and environments to meet community needs

ACTDEK013: Investigate the suitability of materials, systems, components, tools and equipment for a range of purposes

ACTDEK019: Examine how people in design and technologies occupations address competing considerations, including sustainability in the design of products, services, and environments for current and future use

ACTDEK023: Investigate characteristics and properties of a range of materials, systems, components, tools, and equipment, and evaluate the impact of their use

Processes and Production Skills

ACTDEP005: Explore needs or opportunities for designing, and the technologies needed to realise designed solutions

ACTDEP006: Generate, develop, and record design ideas through describing, drawing and modeling

ACTDEP007: Use materials, components, tools, equipment, and techniques to safely make designed solutions

ACTDEP008: Use personal preferences to evaluate the success of design ideas, processes, and solutions, including their care for environment



Curriculum links

ACTDEP014: Critique needs or opportunities for designing and explore and test a variety of materials, components, tools, and equipment, and the techniques needed to produce designed solutions

ACTDEP015: Generate, develop, and communicate design ideas and decisions using appropriate technical terms and graphical representation techniques

ACTDEP016: Select and use materials, components, tools, equipment, and techniques, and use safe work practices to make designed solutions

ACTDEP017: Evaluate design ideas, processes, and solutions based on criteria for success developed with guidance and including care for the environment

ACTDEP024: Critique needs or opportunities for designing, and investigate materials, components, tools, equipment, and processes to achieve intended designed solutions

ACTDEP025: Generate, develop, and communicate design ideas and processes for audiences using appropriate technical terms and graphical representation techniques

ACTDEP026: Select appropriate materials, components, tools, equipment, and techniques, and apply safe procedures to make designed solutions

Digital Technologies

Knowledge and Understanding

ACTDIK001: Recognise and explore digital systems (hardware and software components) for a purpose

ACTDIK007: Identify and explore a range of digital systems with peripheral devices for different purposes, and transmit different types of data

ACTDIK014: Examine the main components of common digital systems and how they may connect together to form networks to transmit data

Processes and Production Skills

ACTDIP004: Follow, describe, and represent a sequence of steps and decisions (algorithms) needed to solve simple problems

ACTDIP010: Define simple problems, and describe and follow a sequence of steps and decisions (algorithms) needed to solve them

ACTDIP011: Implement simple digital solutions as visual programs with algorithms involving branching (decisions) and user input

ACTDIP019: Design, modify, and follow simple algorithms involving sequences of steps, branching, and iteration (repetition)

ACTDIP020: Implement digital solutions as simple visual programs involving branching, iteration (repetition), and user input

Explore phase

Millions of tons of plastic have entered the oceans in recent decades. It is important that the oceans are cleared of plastic bags, bottles, containers, and other debris that are endangering sea animals and fish, and their habitats.

Let students explore collection technology and vehicles currently used and being proposed to clean the oceans of plastic waste.



Create phase

Students design and build a plastic waste collection vehicle or device. Although a prototype, the model should ideally be able to physically collect plastics of a certain type.

Let the students explore the Design Library so they can choose a model for inspiration. Then allow them to experiment and create their own solutions, modifying any basic model as they see fit.

Suggested Design Library models are:

- Reel
- Sweep
- Grab

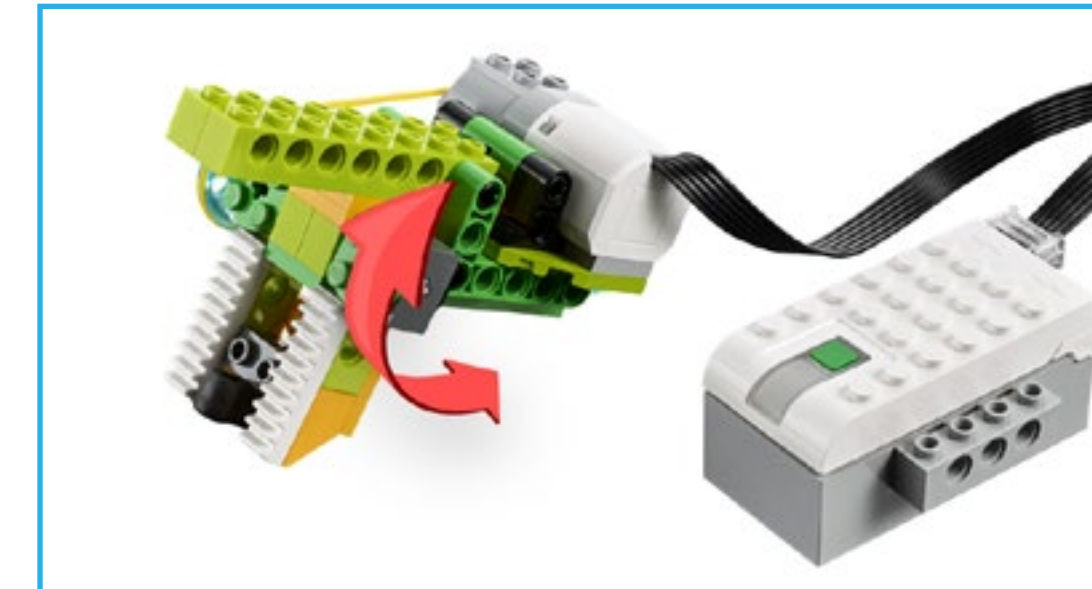
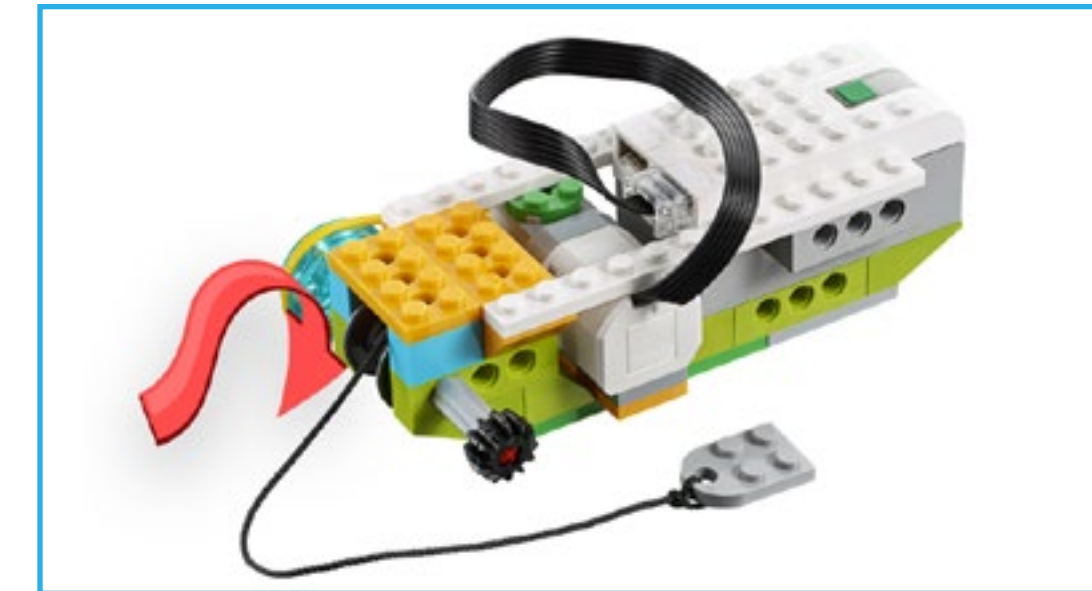

Share phase

Students should present their models, explaining how they have designed the prototype to collect certain types of plastics. They can use research and portfolio documentation to support their explorations and ideas.

Assessment

Ensure that students explain why cleaning the ocean is important, and how their prototype provides an ideal solution to the problem.

Project 15

Wildlife Crossing

This project is about designing a LEGO® prototype to allow an endangered animal species to safely cross a road or other hazardous area.





Curriculum links

Australian Curriculum: Science

Science Understanding

ACSSU073: Living things depend on each other and the environment to survive

Science as a Human Endeavour

ACSHE062: Science knowledge helps people to understand the effect of their actions

Science Inquiry Skills

AC SIS065: With guidance, plan and conduct scientific investigations to find answers to questions, considering the safe use of appropriate materials and equipment

AC SIS216: Compare results with predictions, suggesting possible reasons for findings

AC SIS069: Reflect on the investigation; including whether a test was fair or not

AC SIS071: Represent and communicate observations, ideas, and findings using formal and informal representations

Other Curriculum links

Australian Curriculum: Technologies Design and Technologies

Knowledge and Understanding

ACTDEK004: Explore the characteristics and properties of materials and components that are used to produce designed solutions

ACTDEK013: Investigate the suitability of materials, systems, components, tools, and equipment for a range of purposes

ACTDEK020: Investigate how electrical energy can control movement, sound, or light in a designed product or system

Processes and Production Skills

ACTDEP005: Explore needs or opportunities for designing, and the technologies needed to realise designed solutions

ACTDEP006: Generate, develop, and record design ideas through describing, drawing and modeling

ACTDEP007: Use materials, components, tools, equipment, and techniques to safely make designed solutions

ACTDEP008: Use personal preferences to evaluate the success of design ideas, processes, and solutions, including their care for environment

ACTDEP014: Critique needs or opportunities for designing and explore and test a variety of materials, components, tools, and equipment, and the techniques needed to produce designed solutions

ACTDEP015: Generate, develop, and communicate design ideas and decisions using appropriate technical terms and graphical representation techniques

ACTDEP016: Select and use materials, components, tools, equipment, and techniques, and use safe work practices to make designed solutions

ACTDEP017: Evaluate design ideas, processes, and solutions based on criteria for success developed with guidance and including care for the environment



Curriculum links

ACTDEP024: Critique needs or opportunities for designing, and investigate materials, components, tools, equipment, and processes to achieve intended designed solutions

ACTDEP025: Generate, develop, and communicate design ideas and processes for audiences using appropriate technical terms and graphical representation techniques

ACTDEP026: Select appropriate materials, components, tools, equipment, and techniques, and apply safe procedures to make designed solutions

Digital Technologies

Knowledge and Understanding

ACTDIK001: Recognise and explore digital systems (hardware and software components) for a purpose

ACTDIK007: Identify and explore a range of digital systems with peripheral devices for different purposes, and transmit different types of data

ACTDIK014: Examine the main components of common digital systems and how they may connect together to form networks to transmit data

Processes and Production Skills

ACTDIP004: Follow, describe, and represent a sequence of steps and decisions (algorithms) needed to solve simple problems

ACTDIP010: Define simple problems, and describe and follow a sequence of steps and decisions (algorithms) needed to solve them

ACTDIP011: Implement simple digital solutions as visual programs with algorithms involving branching (decisions) and user input

ACTDIP019: Design, modify, and follow simple algorithms involving sequences of steps, branching, and iteration (repetition)

ACTDIP020: Implement digital solutions as simple visual programs involving branching, iteration (repetition), and user input

Explore phase

Wildlife crossings are structures that allow animals to safely cross human-made barriers. Types of wildlife crossings include underpasses, tunnels, and viaducts. Rescue vehicles are also used in extreme or difficult cases.

Let students explore existing wildlife crossings, especially local examples such as underpasses and cattle crossings. You may also wish to share specific examples of situations or conditions in which wildlife is put at risk and where a crossing may be a solution.



Create phase

Students design and build a wildlife crossing for a chosen type of animal. They could also build the road or hazard that the safe crossing is designed to avoid.

Let students explore the Design Library so they can choose a model for inspiration. Then allow them to experiment and create their own solutions, modifying any basic model as they see fit.

Suggested Design Library models are:

- Spin
- Revolve
- Flex

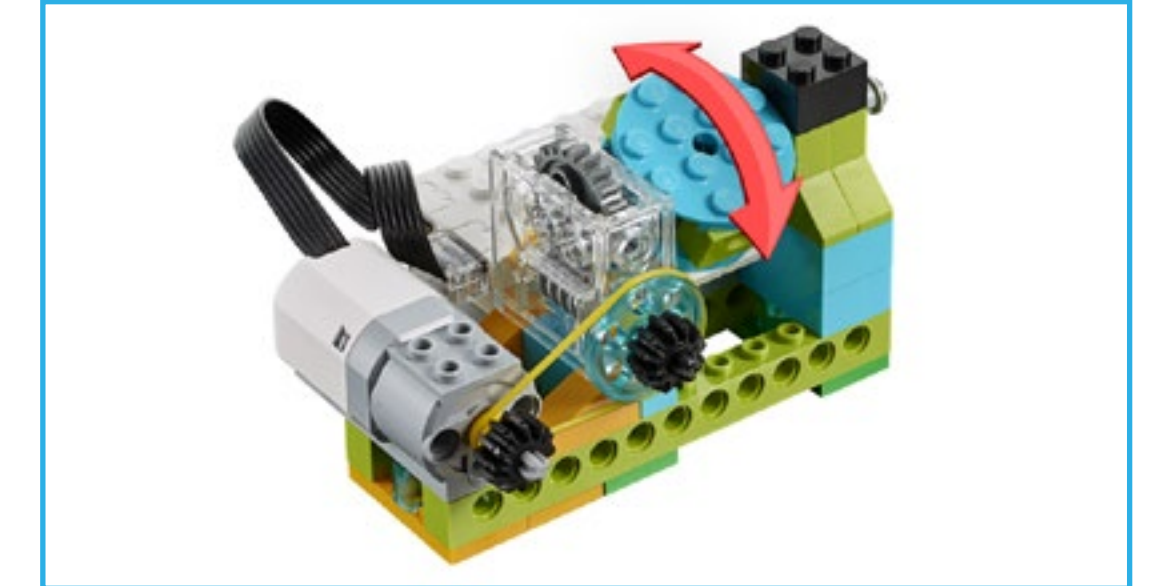
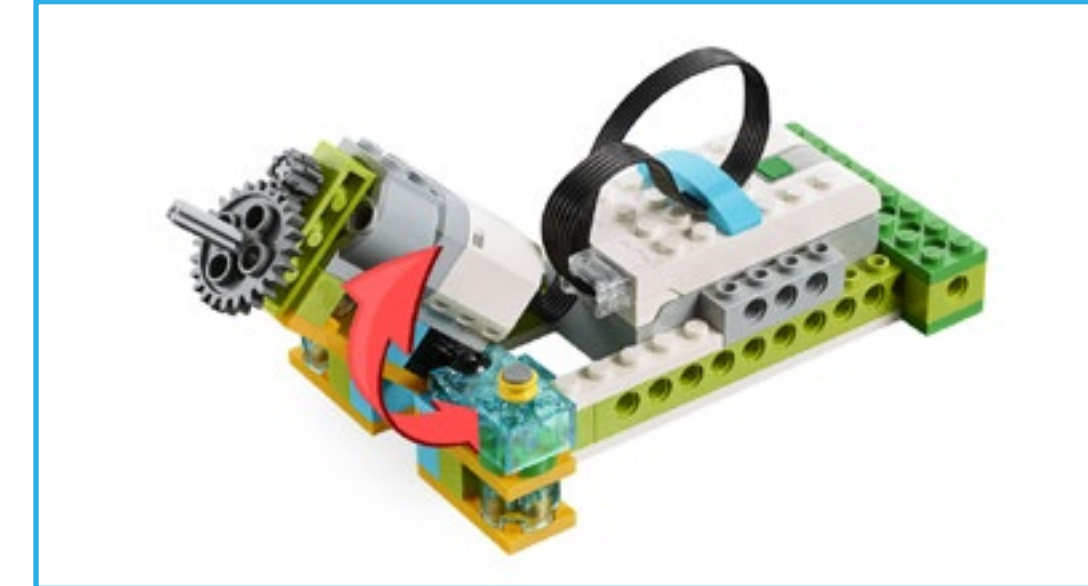

Share phase

Students should present their models, explaining how they have designed the prototype to allow for their chosen wildlife to cross safely. They can use research and portfolio documentation to support their explorations and ideas.

Assessment

Ensure that the students explain why it is important to look after endangered species, and that they understand the impacts humans have on animal habitats.

Project 16

Moving Materials

This project is about designing a LEGO® prototype of a device that can move certain objects around in a safe and efficient way.





Curriculum links

Australian Curriculum: Science

Science Understanding

ACSSU076: Forces can be exerted by one object on another through direct contact or from a distance

Science as a Human Endeavour

ACSHE062: Science knowledge helps people to understand the effect of their actions

Science Inquiry Skills

AC SIS065: With guidance, plan and conduct scientific investigations to find answers to questions, considering the safe use of appropriate materials and equipment

AC SIS069: Reflect on the investigation; including whether a test was fair or not

AC SIS071: Represent and communicate observations, ideas, and findings using formal and informal representations

Other Curriculum links

Australian Curriculum: Technologies Design and Technologies

Knowledge and Understanding

ACTDEK001: Identify how people design and produce familiar products, services, and environments, and consider sustainability to meet personal and local community needs

ACTDEK002: Explore how technologies use forces to create movement in products

ACTDEK004: Explore the characteristics and properties of materials and components that are used to produce designed solutions

ACTDEK010: Recognise the role of people in design and technologies occupations and explore factors, including sustainability that impact on the design of products, services, and environments to meet community needs

ACTDEK011: Investigate how forces and the properties of materials affect the behaviour of a product or system

ACTDEK013: Investigate the suitability of materials, systems, components, tools, and equipment for a range of purposes

ACTDEK020: Investigate how electrical energy can control movement, sound, or light in a designed product or system

ACTDEK023: Investigate characteristics and properties of a range of materials, systems, components, tools, and equipment, and evaluate the impact of their use

Processes and Production Skills

ACTDEP005: Explore needs or opportunities for designing, and the technologies needed to realise designed solutions

ACTDEP006: Generate, develop, and record design ideas through describing, drawing, and modelling

ACTDEP007: Use materials, components, tools, equipment, and techniques to safely make designed solutions



Curriculum links

ACTDEP008: Use personal preferences to evaluate the success of design ideas, processes and solutions

ACTDEP014: Critique needs or opportunities for designing and explore and test a variety of materials, components, tools, and equipment, and the techniques needed to produce designed solutions

ACTDEP015: Generate, develop, and communicate design ideas and decisions using appropriate technical terms and graphical representation techniques

ACTDEP016: Select and use materials, components, tools, equipment, and techniques, and use safe work practices to make designed solutions

ACTDEP017: Evaluate design ideas, processes and solutions based on criteria for success developed with guidance and including care for the environment

ACTDEP024: Critique needs or opportunities for designing, and investigate materials, components, tools, equipment, and processes to achieve intended designed solutions

ACTDEP025: Generate, develop, and communicate design ideas and processes for audiences using appropriate technical terms and graphical representation techniques

ACTDEP026: Select appropriate materials, components, tools, equipment, and techniques, and apply safe procedures to make designed solutions

Digital Technologies

Knowledge and Understanding

ACTDIK001: Recognise and explore digital systems (hardware and software components) for a purpose

ACTDIK007: Identify and explore a range of digital systems with peripheral devices for different purposes, and transmit different types of data

ACTDIK014: Examine the main components of common digital systems and how they may connect together to form networks to transmit data

Processes and Production Skills

ACTDIP004: Follow, describe, and represent a sequence of steps and decisions (algorithms) needed to solve simple problems

ACTDIP010: Define simple problems, and describe and follow a sequence of steps and decisions (algorithms) needed to solve them

ACTDIP011: Implement simple digital solutions as visual programs with algorithms involving branching (decisions) and user input

ACTDIP019: Design, modify, and follow simple algorithms involving sequences of steps, branching, and iteration (repetition)

ACTDIP020: Implement digital solutions as simple visual programs involving branching, iteration (repetition), and user input

Explore phase

The motorised forklift is used to lift and move heavy materials over short distances. It was developed in the early 20th century, but its use became widespread after World War II. Forklifts have become a vital part of warehouse and manufacturing operations.

Let students explore forklift designs and other ways to move objects, and make observations about the way these devices lift and move materials.

▶ Important

The focus of this project could be on both the device used to move the objects and on the way the objects are prepared to be moved, such as stacking them on pallets or in containers.



Create phase

Students design and build a vehicle or a device for lifting, moving, and/or packing a pre-determined set of objects. They should also consider how boxes can be designed to be moved and stored easily.

Let the students explore the Design Library so they can choose a model for inspiration. Then allow them to experiment and create their own solutions, modifying any basic model as they see fit.

Suggested Design Library models are:

- Steer
- Grab
- Motion

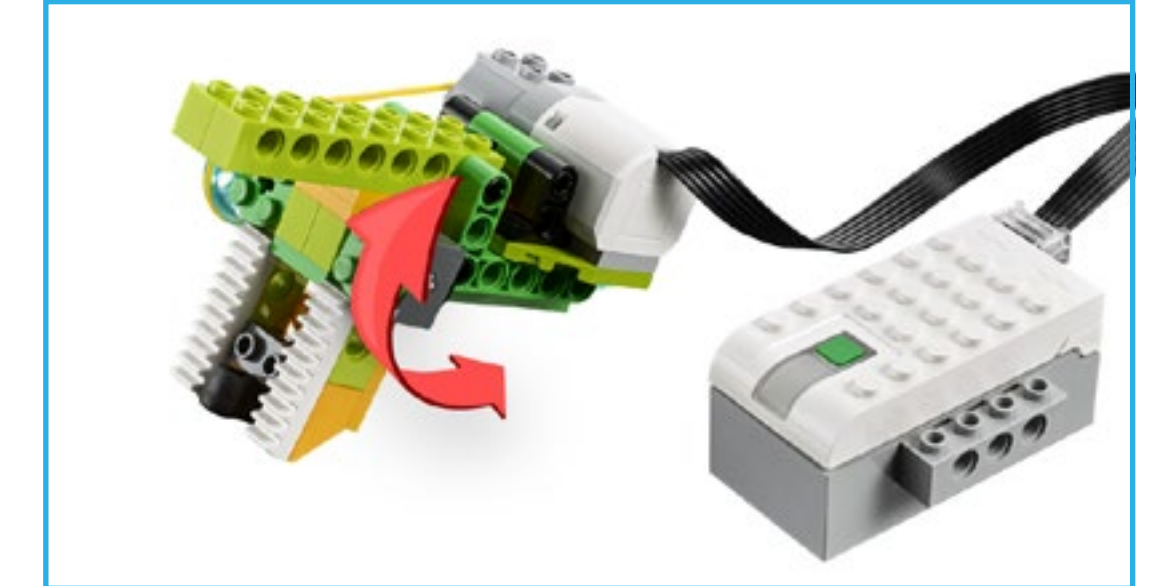

Share phase

Students should present their models, explaining how the vehicle was designed to move objects. They can use research and portfolio documentation to support their explorations and ideas.

Assessment

Ensure that students explain how boxes can be designed to be moved and stored easily and how the design allows vehicles to do this efficiently.

LEGO® Education WeDo 2.0 Toolbox

Program with WeDo 2.0
209-216

Build with WeDo 2.0
217-231



Program with WeDo 2.0

Programming is an important part of 21st century learning, and it is an essential part of all WeDo 2.0 projects.

It brings life to the models that students create and teaches them computational thinking.





Introduction to a WeDo 2.0 program string

To bring life to their models, the students will drag and drop blocks onto the Programming Canvas. Your students will be creating program strings. They can create multiple program strings on the canvas, but each needs to start with a Start Block.

Here are some important terms to use:

1. Start Block – a Start Block is required to execute a program string.
“Execute” means to start a series of actions until they are completed.
2. Programming block – programming blocks are used in the WeDo 2.0 Software to build a program string. Blocks with symbols are used instead of text code.
3. Program string – a program string is a sequence of programming blocks.

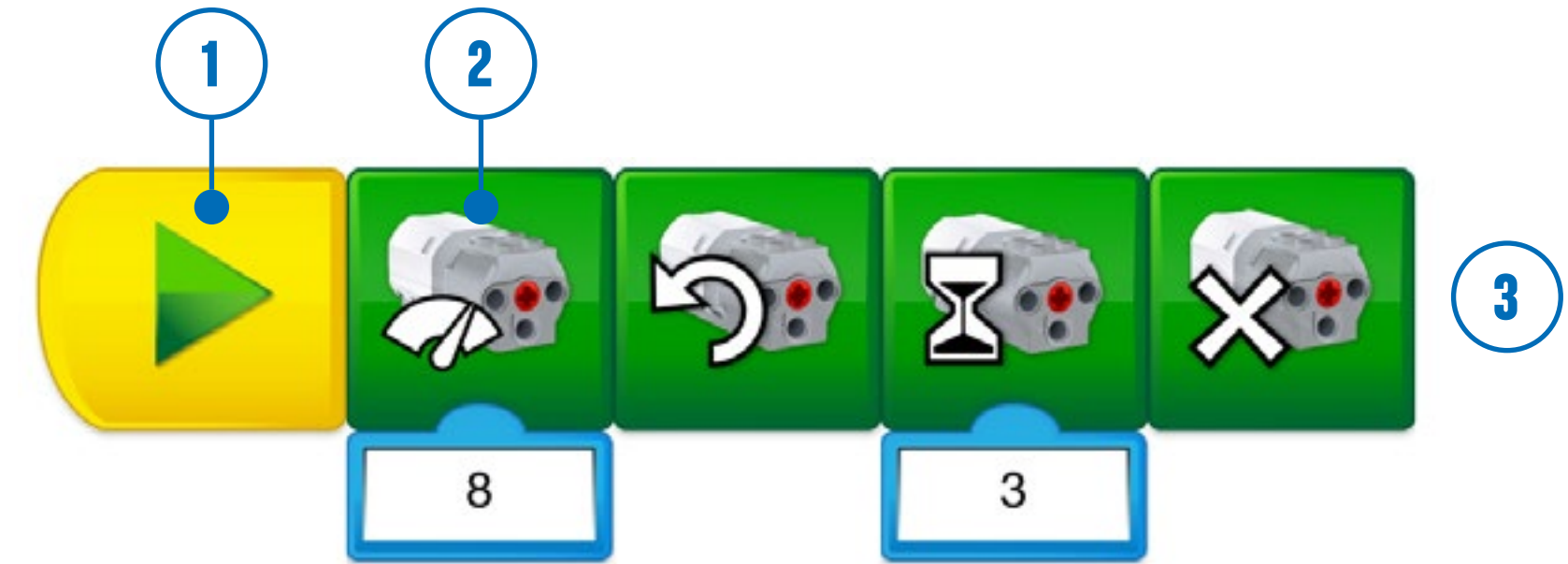



Top five program strings

The following program strings are used to complete some of the most important functions when working with WeDo 2.0. It is recommended that you and your students make yourselves familiar with them.

▶ Important

In WeDo 2.0, the unit of time has been set to seconds. Students should therefore input:

- 1 – for the motor to run for one second
- 4.5 – for the motor to run for four and a half seconds

Program string 1

Is my motor working?

The main function of this program is to test the motor. When you press start, the power of the motor will be set to 10, and the motor will turn in one direction for three seconds, then in the opposite direction for three seconds, and then stop.





Top five program strings

Program string 2

Is my sensor responding?

To be able to use this program, you need a motor and a Motion Sensor attached to the Smarthub. By executing the program, the motor will run in one direction and wait for an object (e.g., your hand) to pass in front of the Motion Sensor. When an object is detected, the motor will stop.

The same program can be used with the Tilt Sensor Input or the Sound Sensor Input by changing the attachment of the Wait For Block.



Program string 3

Is the light flashing?

This program tests the light of the Smarthub. By executing the program, the light will illuminate for one second and then turn off for one second. This action is repeated, causing the light on the Smarthub to flash.





Top five program strings

Program string 4

Does my device play sounds?

This program will play sound No.1 from your device.



Program string 5

Is my device displaying images?

This program will show image No.1 as well as the word "WeDo" on the display.





Other programming opportunities

The following programs are also frequently used when working with WeDo 2.0. Once the top five program strings have been explored, it is recommended that you and your students make yourselves familiar with their functions.

Program string 6

Using the Random Input

This program string will randomly change the colour of the light on the Smarthub. The colour of the bulb will change at one second intervals.





Other programming opportunities

Program string 7

Activating two motors at the same time

You can label Motor Blocks and Sensor Inputs if you are using more than one at a time. You can use a maximum of three LEGO® Smarthubs at any one time.

To label a block or an Input, Long Press the block you need to label to open the Labelling panel:

- Press once to label with one dot.
- Press again to label from two to six dots.
- Press again to remove the label.

If a Motor Block is not labelled and more than one motor is connected, all motors will be executed in the same way. If a Sensor Input block is not labelled and more than one sensor is connected, it waits for one of the connected sensors.



Program string 8

Use the Sound Sensor Input

This program string will run the motor at a power level that is equal to the level of sound detected by the microphone on the device:

- If the sound level is low, the motor will run slowly.
- If the sound level is high, the motor will run quickly.





Other programming opportunities

Program string 9

Create a countdown

This program string will display numbers on the screen, starting from five, and then count down in one second increments. When the loop has run five times, a sound will be played.



Program string 10

Do two things at the same time

When the Play icon is tapped, it will send a message No.1 (WeDo) to the Programming Canvas. All of the “play on” message blocks that have message No.1 (WeDo) will then be triggered, playing, in this case, a sound and displaying an image at the same time.



Build with WeDo 2.0

WeDo 2.0 has been designed to provide opportunities for students to sketch, build, and test prototypes and representations of objects, animals, and vehicles that have a real-world focus.

The hands-on approach encourages students to be fully engaged in the designing and building process.





The importance of designing in WeDo 2.0

The WeDo 2.0 projects will take you and your students on a journey of using mechanisms in their models. These mechanisms will bring your students' models to life.

The mechanisms have been ordered by their function, in the Design Library. In the software, students will find building instructions that will enable their models to:

1. Wobble
2. Drive
3. Crank
4. Walk
5. Spin
6. Flex
7. Reel
8. Lift
9. Grab
10. Push
11. Revolve
12. Steer
13. Sweep
14. Detect motion
15. Detect tilt

These are provided to give inspiration to your students when they look for solutions. All these functions use what is called “simple machines” that you can explore together with your students.





Base models exploration

Name of the part: Gear

A gear is a toothed wheel that rotates and makes another part move. You can find gear wheels on your bicycle, they are linked together by a chain. A gear train is a system of gears that transmits motion from one part to another.

Types of gear train

Gear up: A large gear drives a small gear to produce more rotations.

Gear down: A small gear drives a large gear to produce fewer rotations.

Used in Design Library base models

Walk, Spin



Name of the part: Bevel gear

This is an angled gear that can be placed perpendicular to another gear, changing the axis of rotation.

Used in Design Library base models

Flex, Wobble, Push

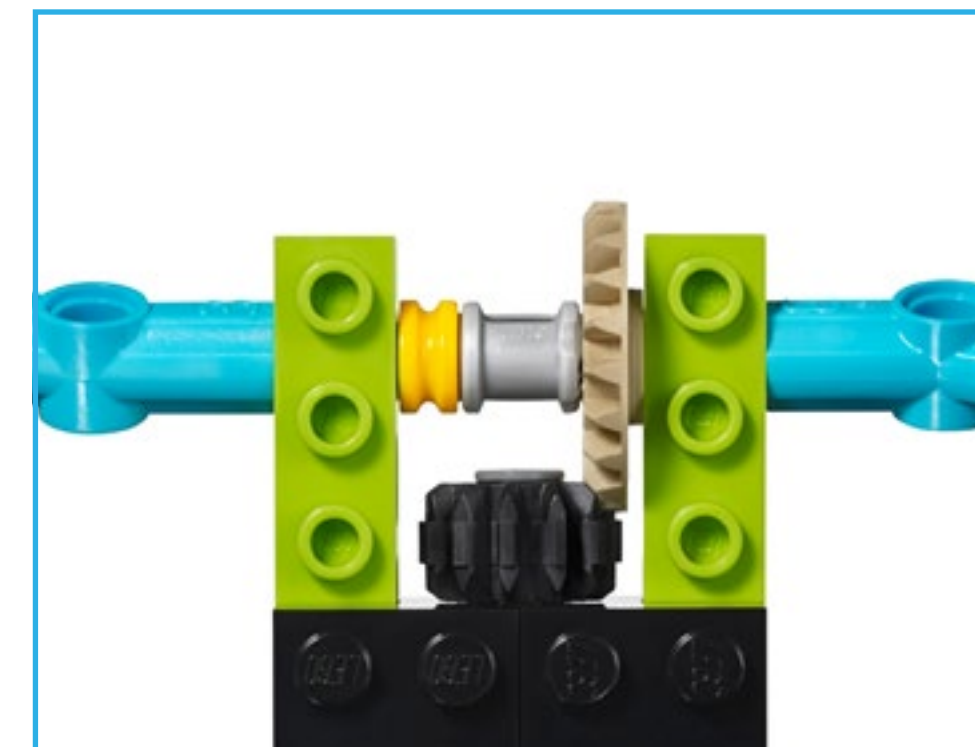



Base models exploration

Name of the part: Rack

A rack is a flat element with teeth that engage a circular gear, often referred to as a pinion. This changes ordinary rotational motion into linear motion.

Used in Design Library base models

Push



Name of the part: Worm gear

A worm is a continual spiral groove like a screw, which meshes with a gear. The worm is designed to turn a normal gear, but the gear cannot turn the worm, therefore, it can also function as a brake.

Used in Design Library base models

Revolve

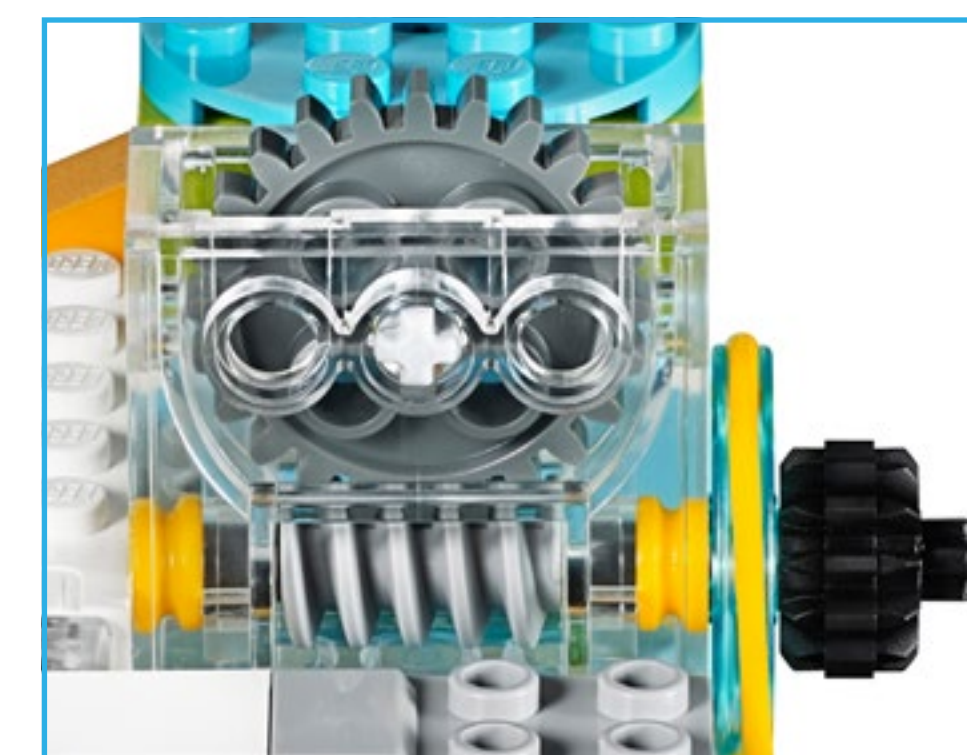



Base models exploration

Name of part: Beam

A beam attached to a rotating part will become a piston rod. The piston rod is a moving component of a machine, transferring the energy created by the motor into an up/down or forward/backward motion. This motion can push, pull, or drive other mechanical elements of the same machine.

Used in Design Library base models

Crank



Name of the part: Wheels

A circular element that rotates on an axis to produce propelling movement.

Used in Design Library base models

Wobble, Drive, Steer





Base models exploration

Name of the part: Pulley

The pulley is a wheel with a grooved rim that accommodates the belt. The belt is a small rubber band, which connects to a part of the model that is rotating, transferring the rotation to a different part of the model.

Pulley up: A large pulley drives a small pulley to produce more rotations.

Pulley down: A small pulley drives a large pulley to produce fewer rotations.

Pulley twist: Used to make shafts that are parallel but rotate in opposite directions.

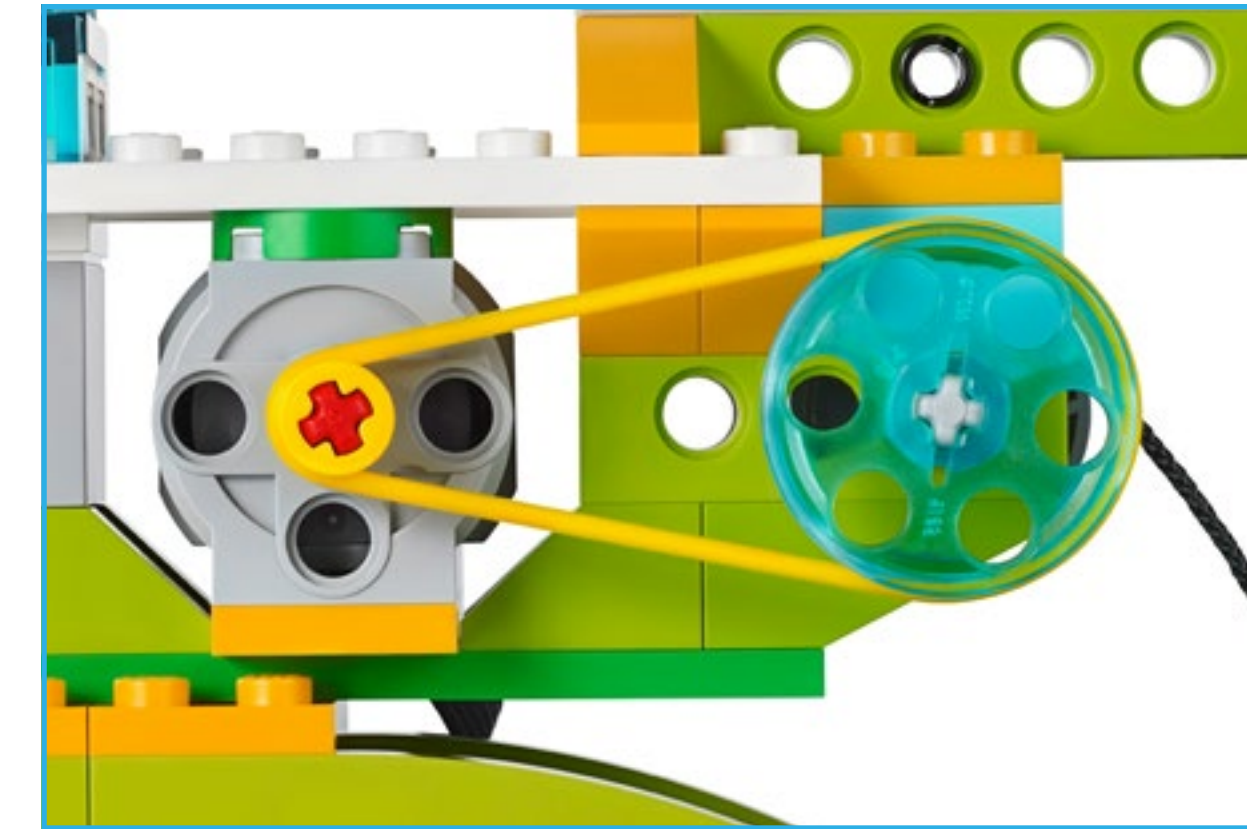

Used in Design Library base models

Reel, Lift, Drive, Sweep, Revolve, Grab

▶ Important

Using a pulley in a mechanism will prevent the model from breaking when it meets resistance, as the belt will slip in the pulley.

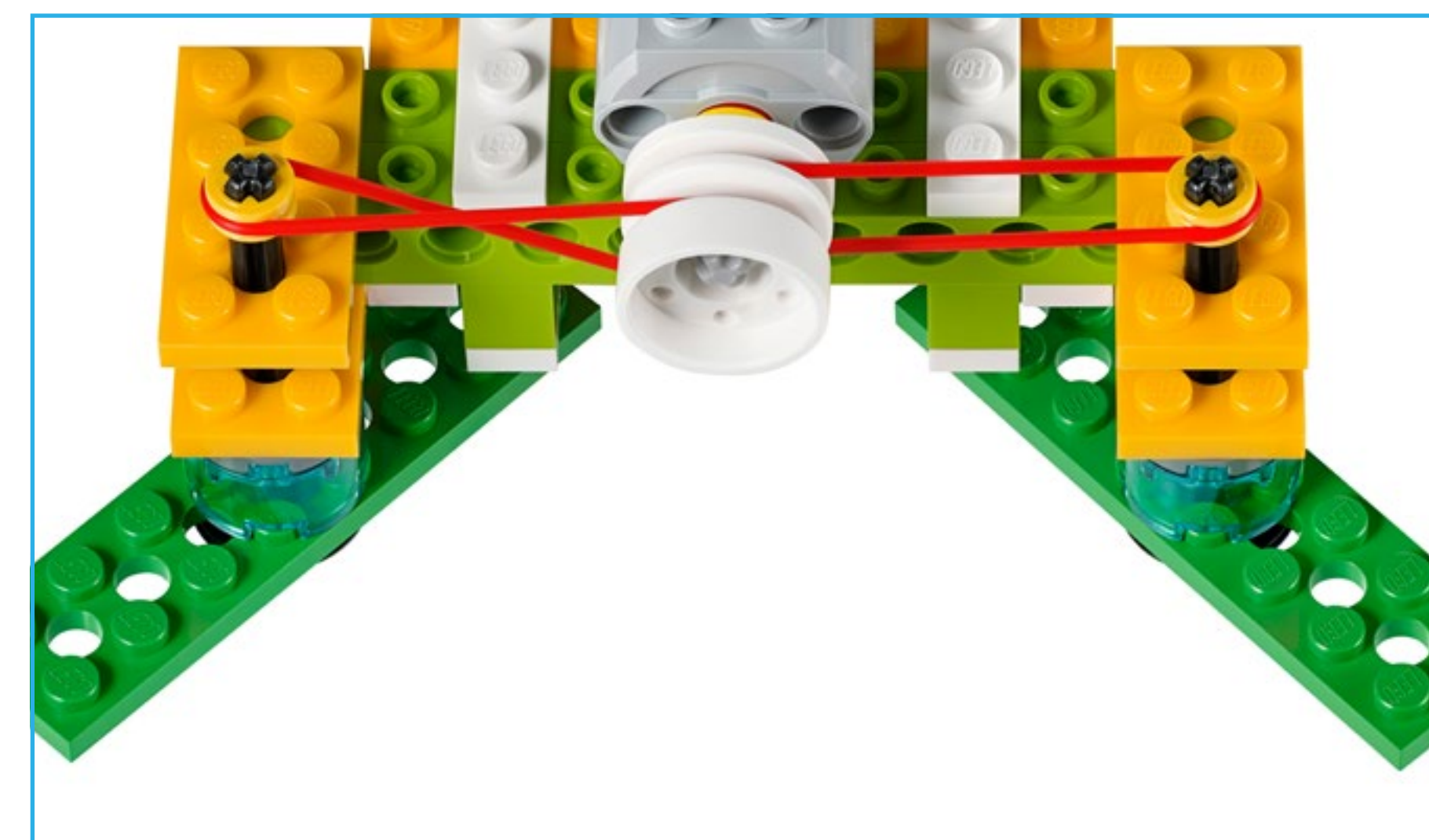



Electronic parts

Smarthub

The Smarthub acts as a wireless connector between your device and the other electronic parts, using Bluetooth Low Energy. It receives and executes program strings from each device.

The Smarthub features:

- Two ports to connect sensors or motors
- A light
- A power button

The Smarthub uses AA batteries or the supplementary Rechargeable Battery as a power source.

The Bluetooth connection procedure between the Smarthub and your device is explained in the WeDo 2.0 Software.

The Smarthub will use colour patterns to signal messages:

- Flashing white light: Waiting for a Bluetooth connection.
- Blue light: Bluetooth connection is established.
- Flashing orange light: The power provided to the motor is at its limit.





Electronic parts

Smarthub Rechargeable Battery (supplementary item)

Here are some guidelines for the Smarthub Rechargeable Battery:

- To maximise the hours of play available without the adaptor connected, make sure that the battery is fully charged before you begin.
- There are no special requirements for charging patterns.
- Preferably, store the battery in a cool place.
- Recharging is recommended if the battery has been installed in the Smarthub, without use, for more than one month.
- Do not let the battery charge for an extended period of time.



Medium Motor

Motors makes other things move. This Medium Motor uses electricity to make an axle rotate.

The motor can be started in both directions, can be stopped, and can run at different speeds for a specified amount of time (seconds).





Electronic parts: sensors

Tilt Sensor

To interact with this sensor, tilt the part in different directions, following the arrows.

The sensor can detect changes in six different positions:

- Tilt this way
- Tilt that way
- Tilt up
- Tilt down
- No tilt
- Any tilt

Make sure that the icon in your program corresponds to the position you are trying to detect.



Motion Sensor

This sensor detects changes in distance from an object within its range, in three different ways:

- Object moving closer
- Object moving further away
- Object changing position

Make sure that the icon in your program corresponds to the position you are trying to detect.





Part names and primary functions

As students use the bricks, you may want to discuss proper vocabulary as well as functions for each part in the set.

- Some of them are structural parts that hold a model together.
- Some parts are connectors that link elements to each other.
- Some parts are used to produce movement.

▶ Important

Remember that these categories are guidelines. Some parts have many functions and can be used in many ways.

▶ Suggestion

Use the compartment tray when sorting the parts in the WeDo 2.0 storage box. This will help you and your students when viewing and counting the parts.

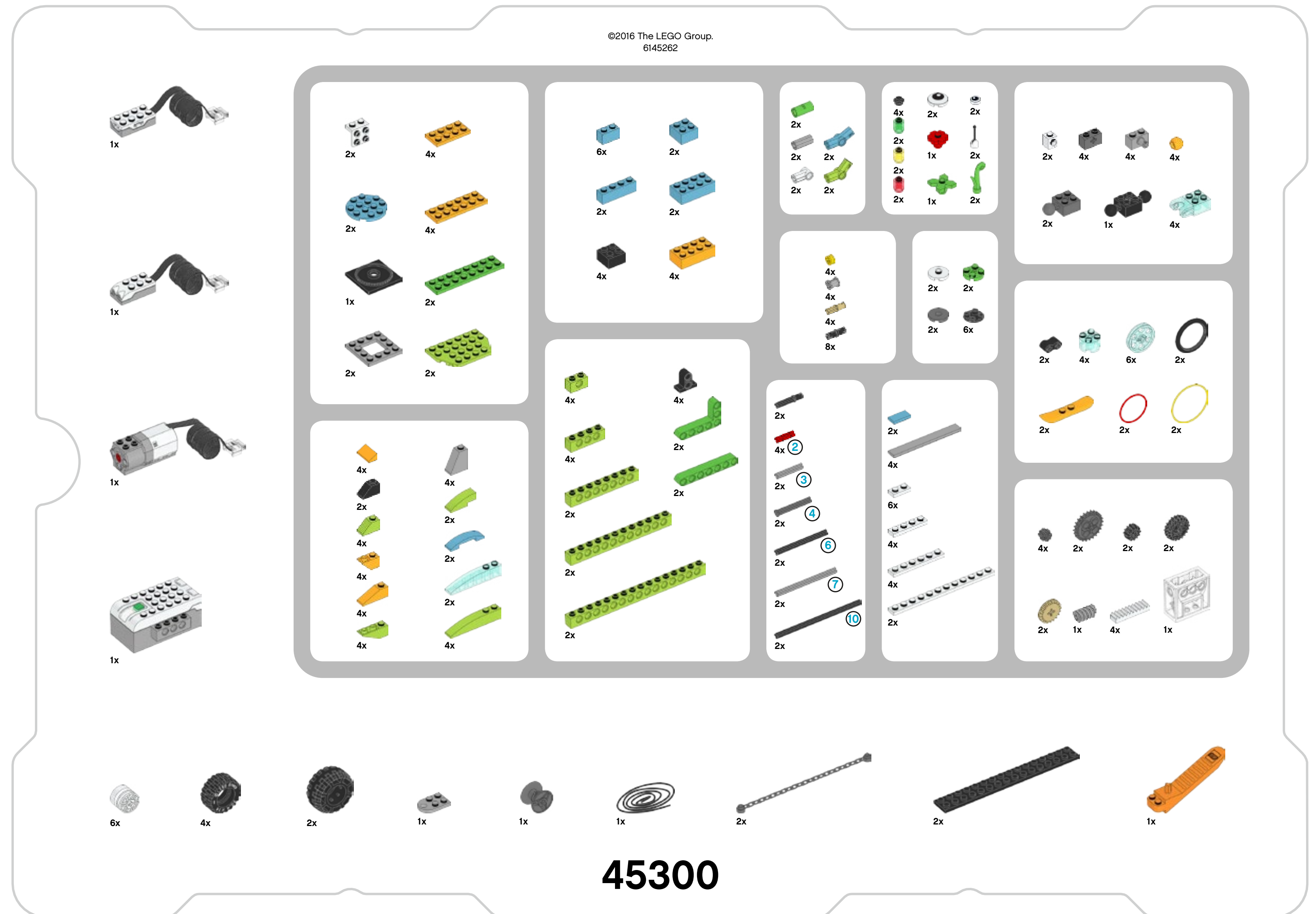



Structural parts



2x - Angular plate, 1x2/2x2, white. No.6117940



4x - Roof brick, 1x2x2, grey. No.4515374



2x - Tile, 1x2, azure blue. No.4649741



4x - Roof brick, 1x2/45°, lime green. No.4537925

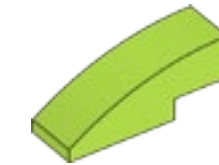

2x - Curved brick, 1x3, lime green. No.4537928



4x - Roof brick, 1x2x2/3, bright orange. No.6024286

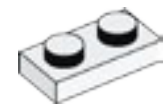

6x - Plate, 1x2, white. No.302301

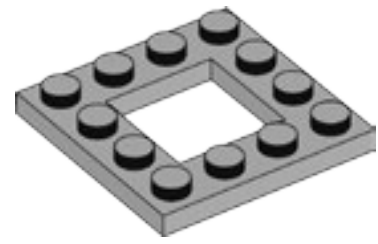

2x - Frame plate, 4x4, grey. No.4612621

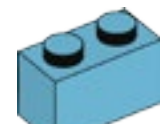

6x - Brick, 1x2, azure blue. No.6092674

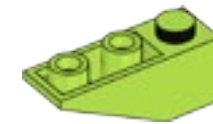

4x - Inverted roof brick, 1x3/25°, lime green. No.6138622

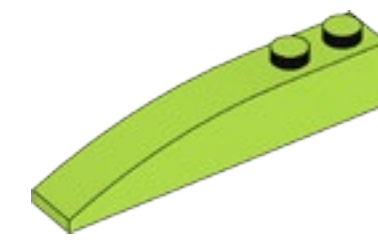

4x - Curved brick, 1x6, lime green. No.6139693



4x - Inverted roof brick, 1x2/45°, bright orange. No.6136455



4x - Plate, 1x4, white. No.371001

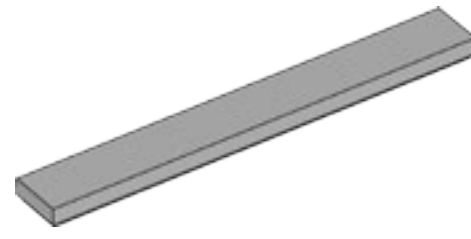

4x - Tile, 1x8, grey. No.4211481



2x - Brick, 2x2, azure blue. No.4653970

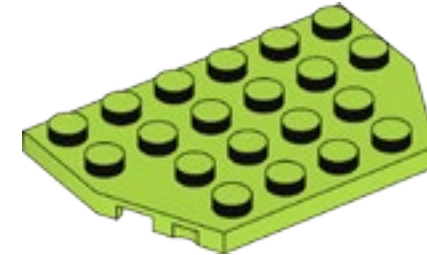

2x - Plate, 4x6/4, lime green. No.6116514

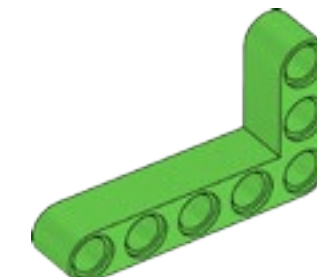

2x - Angular beam, 3x5-modules, bright green. No.6097397

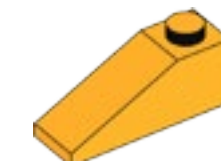

4x - Roof brick, 1x3/25°, bright orange. No.6131583



4x - Plate, 1x6, white. No.366601

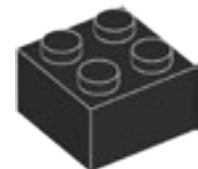

4x - Brick, 2x2, black. No.300326

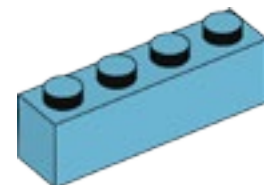

2x - Brick, 1x4, azure blue. No.6036238



4x - Studded beam, 1x2, lime green. No.6132372

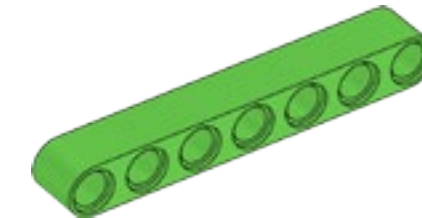

2x - Beam, 7-modules, bright green. No.6097392

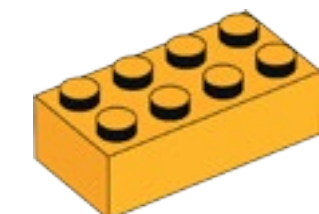

4x - Brick, 2x4, bright orange. No.6100027

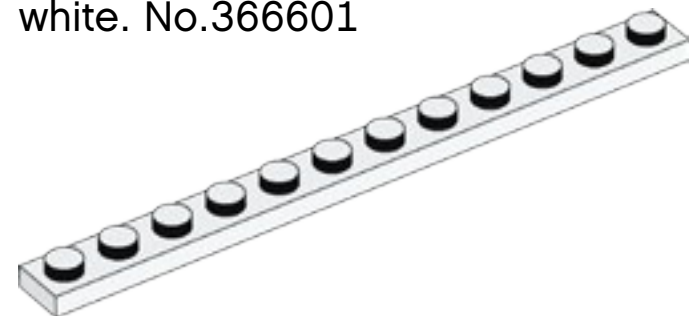

2x - Plate, 1x12, white. No.4514842

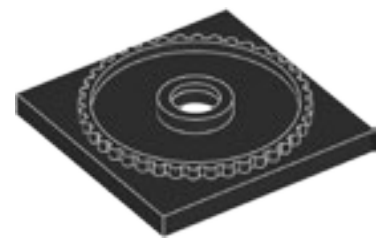

1x - Bottom for turntable, 4x4, black. No.4517986

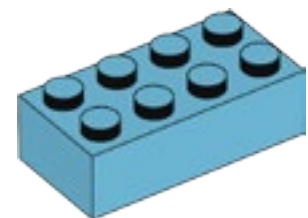

2x - Brick, 2x4, azure blue. No.4625629

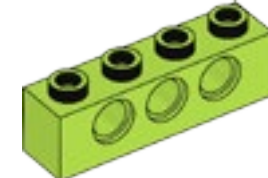

4x - Studded beam, 1x4, lime green. No.6132373

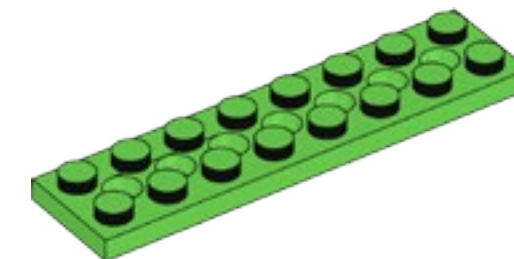

2x - Plate with holes, 2x8, bright green. No.6138494

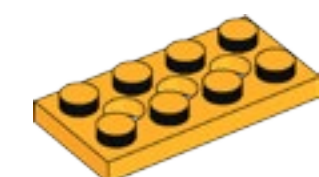

4x - Plate with holes, 2x4, bright orange. No.6132408



4x - Beam with plate, 2-modules, black. No.4144024



2x - Curved plate, 1x4x2/3, azure blue. No.6097093

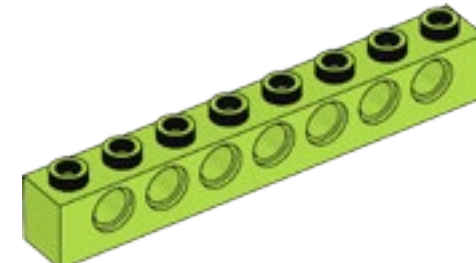

2x - Studded beam, 1x8, lime green. No.6132375

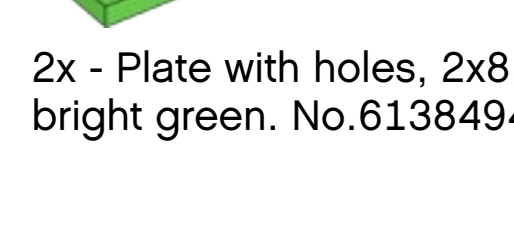

4x - Plate with holes, 2x6, bright orange. No.6132409



2x - Roof brick, 1x2/45°, black. No.4121966



2x - Round plate, 4x4, azure blue. No.6102828

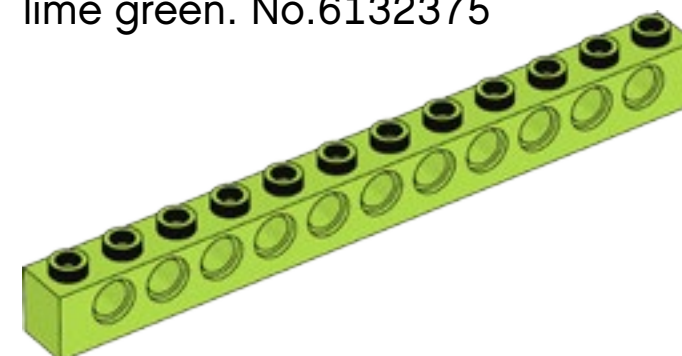

2x - Studded beam, 1x12, lime green. No.6132377

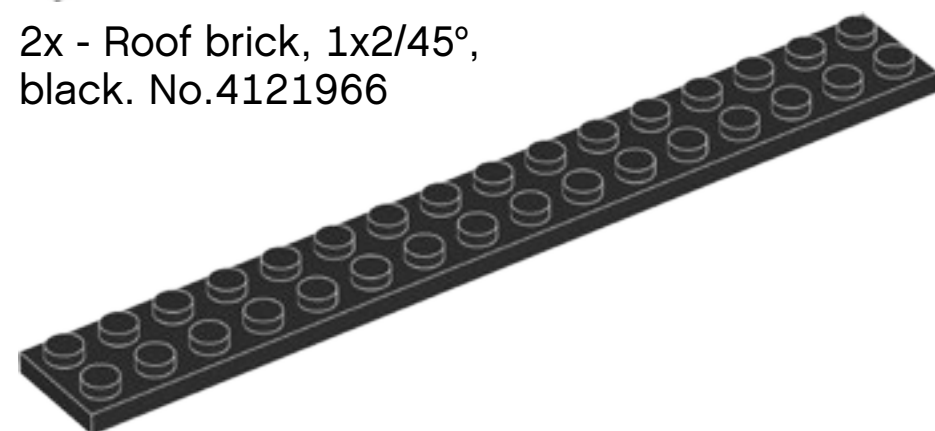

2x - Plate, 2x16, black. No.428226

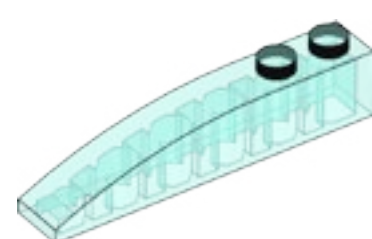

2x - Curved brick, 1x6, transparent light blue. No.6032418

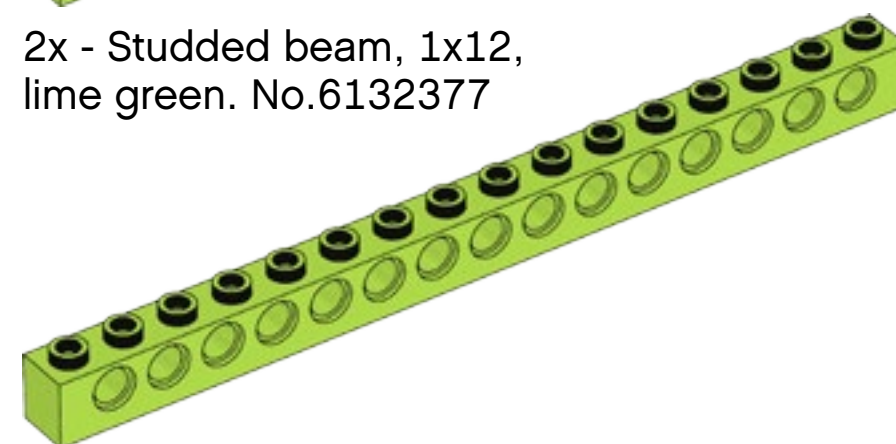

2x - Studded beam, 1x16, lime green. No.6132379

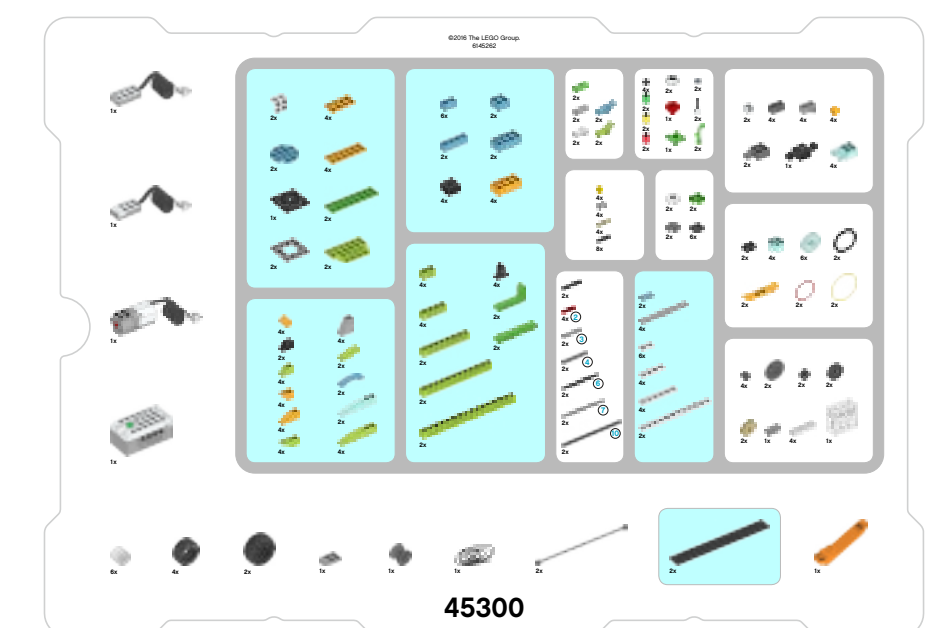



Connecting parts



2x - Brick with stud on side, 1x1, white. No.4558952



4x - Bushing, 1-module, grey. No.4211622



8x - Connector peg, with friction, 2-modules, black. No.4121715

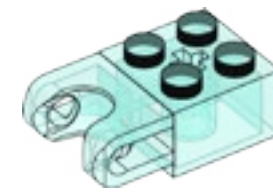

4x - Brick with ball bearing, 2x2, transparent light blue. No.6045980



2x - Angular block 4, 135°, lime green. No.6097773



4x - Connector peg, without friction/axle, 1-module/1-module, beige. No.4666579



2x - Angular block 1, 0°, white. No.4118981



2x - Bushing/axle extender, 2-module, grey. No.4512360

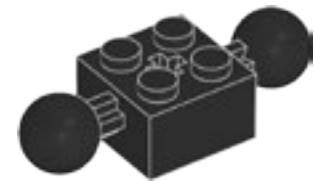

1x - Brick with 2 ball joints, 2x2, black. No.6092732

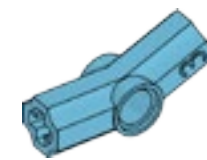

2x - Angular block 3, 157,5°, azure blue. No.6133917



2x - Tube, 2-modules, bright green. No.6097400



4x - Ball with crosshole, bright orange. No.6071608

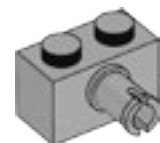

4x - Brick with connector peg, 1x2, grey. No.4211364



1x - String, 50 cm, black. No.6123991



4x - Bushing/pulley, 1/2-module, yellow. No.4239601



1x - Plate with hole, 2x3, grey. No.4211419



4x - Studded beam with crosshole, 1x2, dark grey. No.4210935

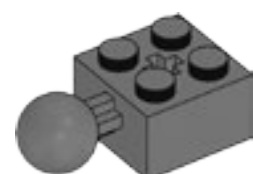

2x - Brick with 1 ball joint, 2x2, dark grey. No.4497253



1x - Bobbin, dark grey. No.4239891

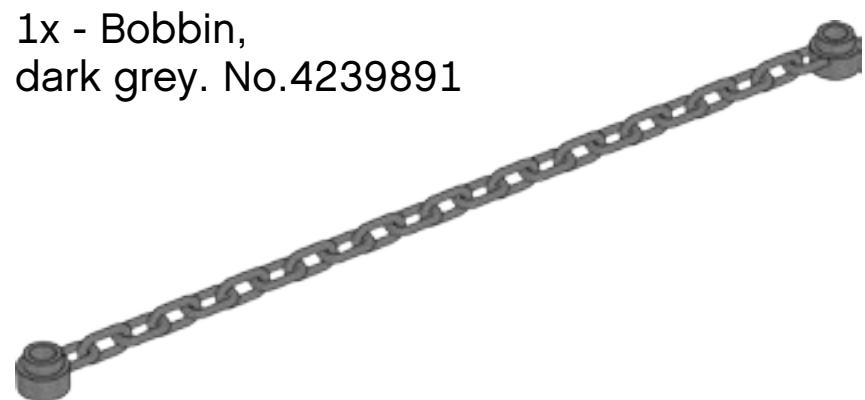

2x - Chain, 16-modules, dark grey. No.4516456

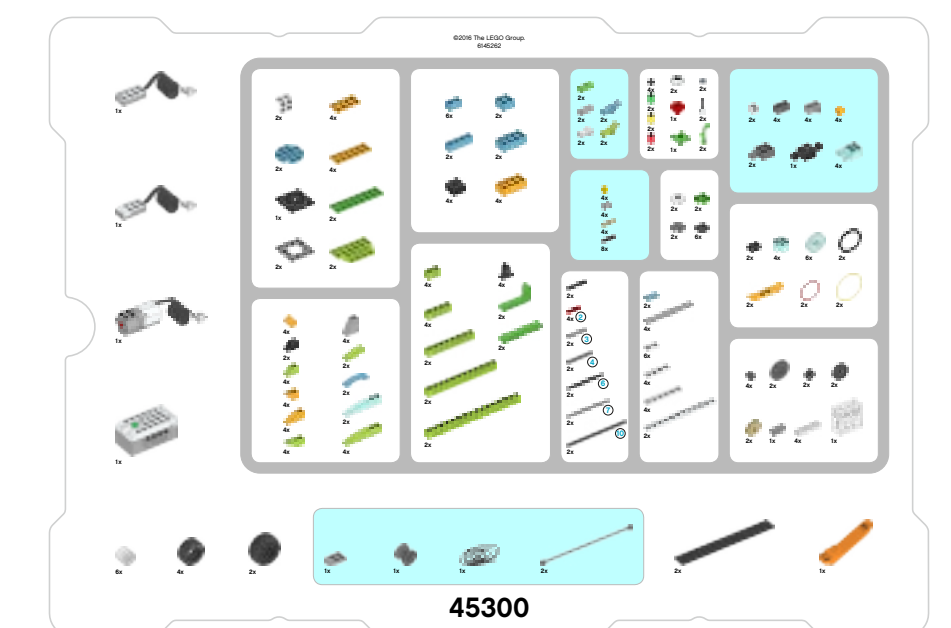



Movement parts



6x - Hub/pulley, 18x14 mm, white. No.6092256



1x - Worm gear, grey. No.4211510



2x - Rubber beam with crossholes, 2-modules, black. No.4198367



4x - Axle, 2-modules, red. No.4142865



2x - Bevel gear, 20-tooth, beige. No.6031962

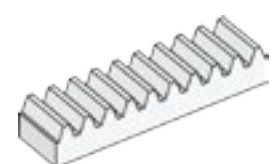

4x - Gear rack, 10-tooth, white. No.4250465



4x - Gear, 8-tooth, dark grey. No.6012451



2x - Double bevel gear, 12-tooth, black. No.4177431



2x - Connector peg with axle, 3-modules, black. No.6089119



2x - Belt, 33 mm, yellow. No.4544151

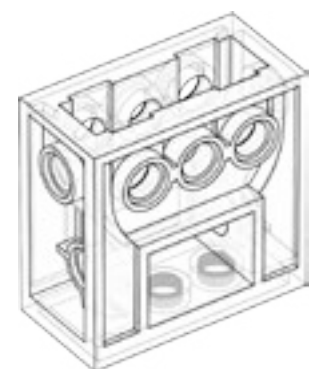

1x - Gear block, transparent. No.4142824



2x - Gear, 24-tooth, dark grey. No.6133119



2x - Double bevel gear, 20-tooth, black. No.6093977

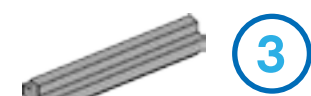

2x - Axle, 3-modules, grey. No.4211815



2x - Snowboard, bright orange. No.6105957



2x - Tyre, 30.4x4 mm, black. No.6028041



2x - Axle with stop, 4-modules, dark grey. No.6083620



2x - Belt, 24 mm, red. No.4544143



4x - Round brick, 2x2, transparent light blue. No.4178398



4x - Tyre, 30.4x14 mm, black. No.4619323



2x - Axle, 6-modules, black. No.370626

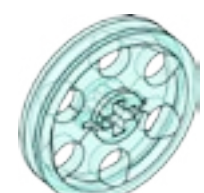

6x - Hub/pulley, 24x4 mm, transparent light blue. No.6096296



2x - Tyre, 37x18 mm, black. No.4506553

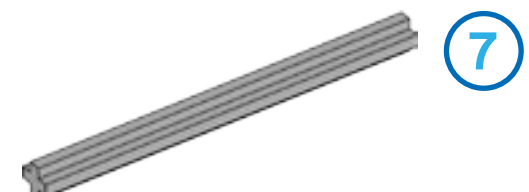

2x - Axle, 7-modules, grey. No.4211805

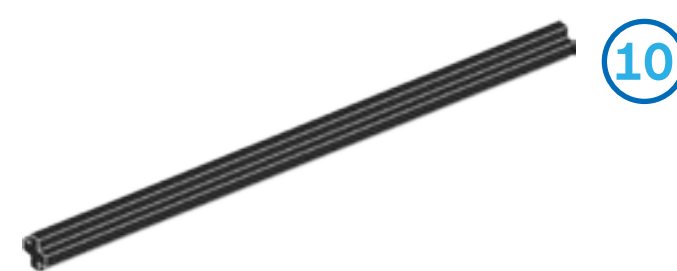

2x - Axle, 10-modules, black. No.373726

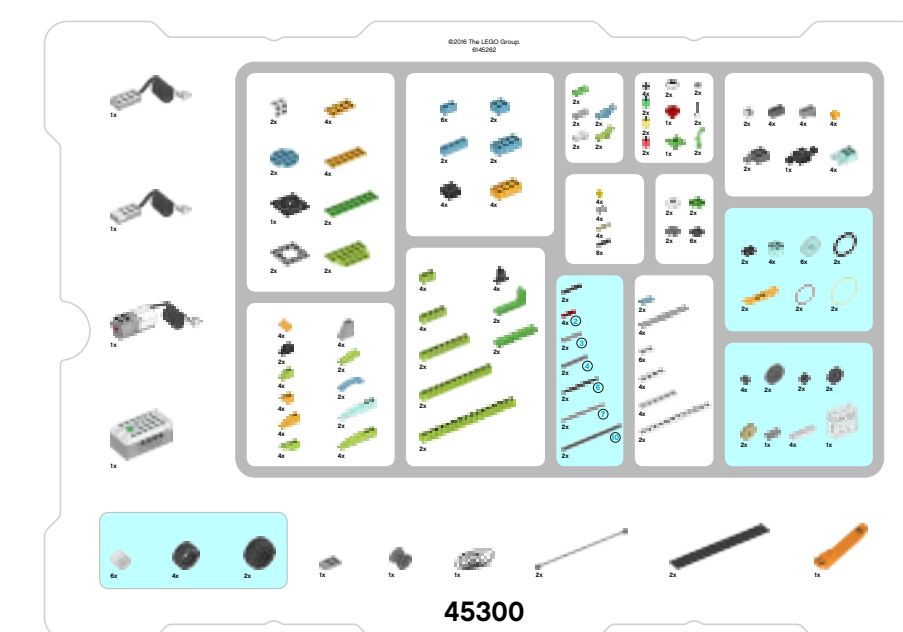



Decorative parts



2x - Antenna, white. No.73737



2x - Round brick, 1x1, transparent green. No.3006848



2x - Round brick, 1x1, transparent yellow. No.3006844



2x - Round tile with eye, 1x1, white. No.6029156



2x - Grass, 1x1, bright green. No.6050929



2x - Round brick, 1x1, transparent red. No.3006841



2x - Round tile with eye, 2x2, white. No.6060734



2x - Round plate, 2x2, bright green. No.6138624



1x - Flower, 2x2, red. No.6000020



2x - Round plate with 1 stud, 2x2, white. No.6093053



1x - Leaves, 2x2, bright green. No.4143562

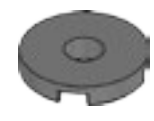

2x - Round tile with hole, 2x2, dark grey. No.6055313



4x - Round plate, 1x1, black. No.614126



6x - Skid plate, 2x2, black. No.4278359

Brick separator

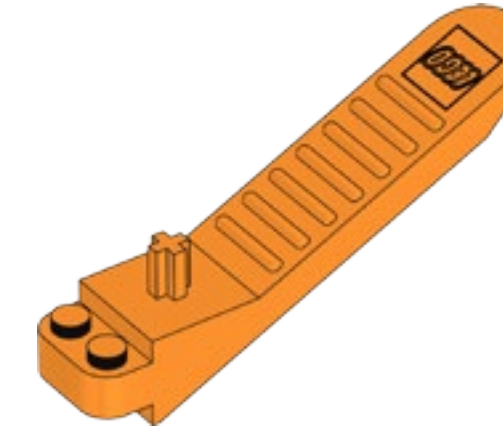

1x - Element separator, orange. No.4654448

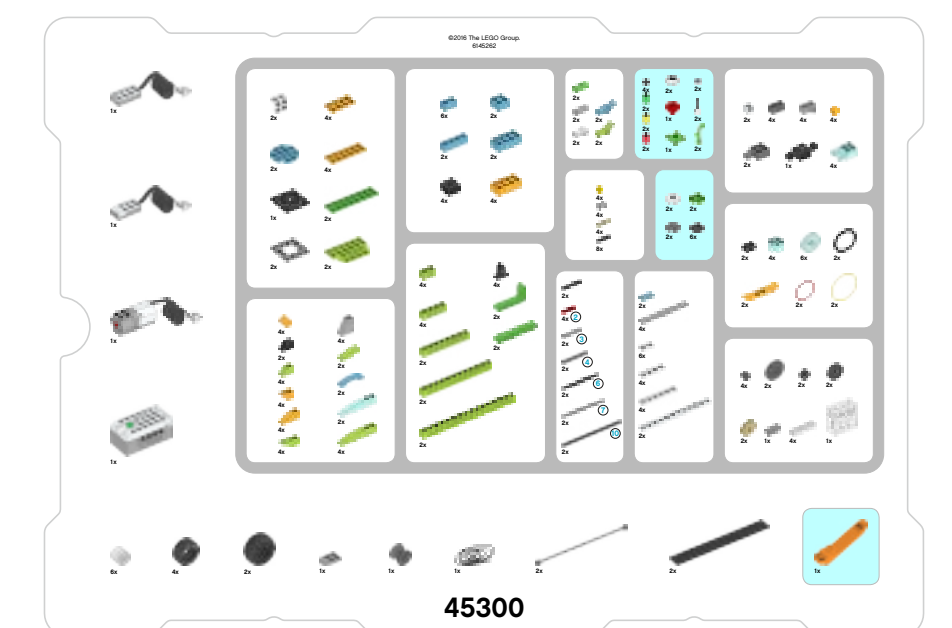



Electronic parts



1x - Tilt Sensor,
white. No.6109223

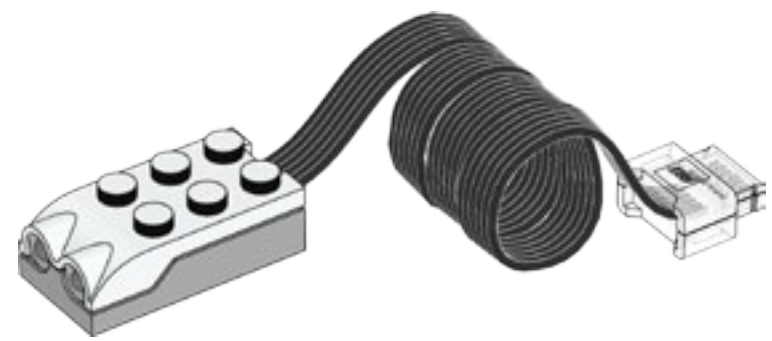

1x - Motion Sensor,
white. No.6109228

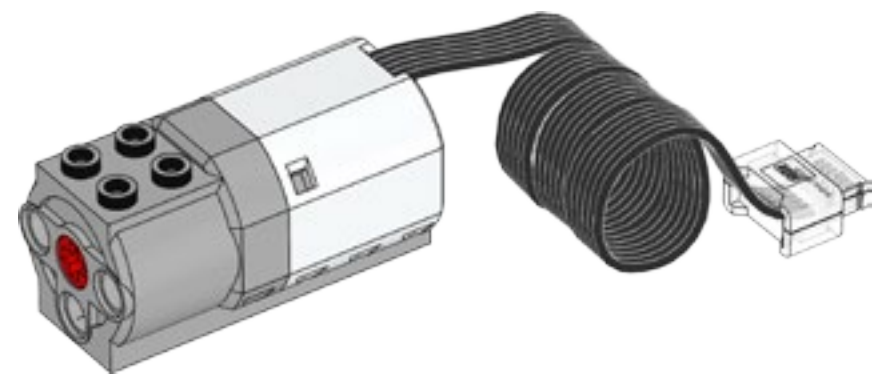

1x - Medium Motor,
white. No.6127110

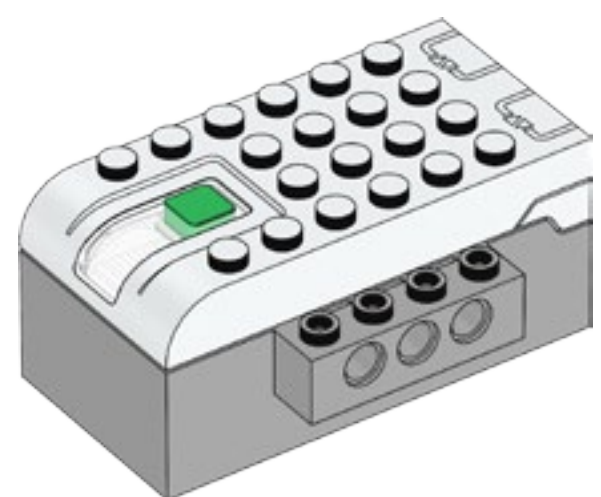

1x - Smarthub,
white. No.6096146

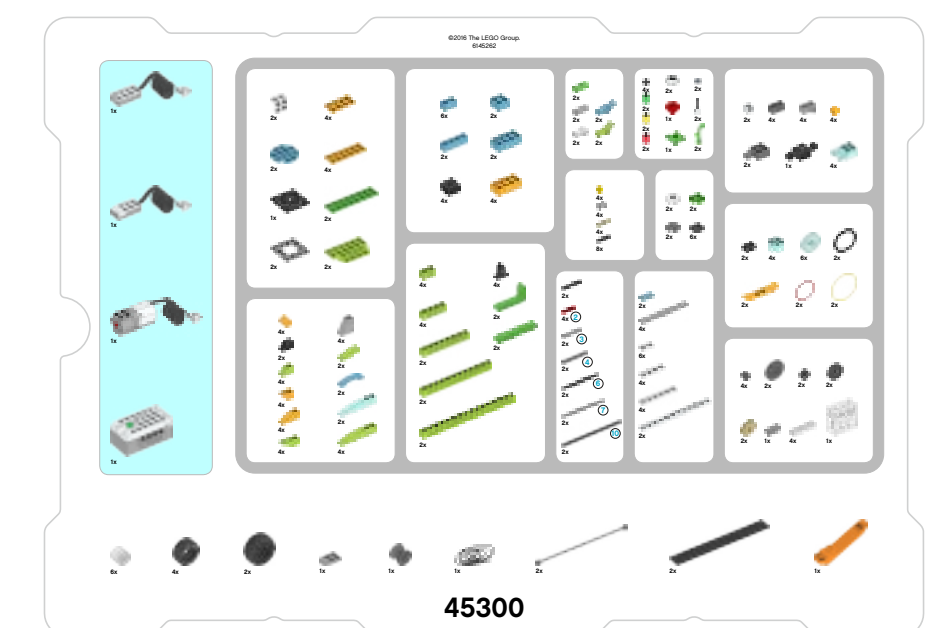

LEGO® Education WeDo 2.0

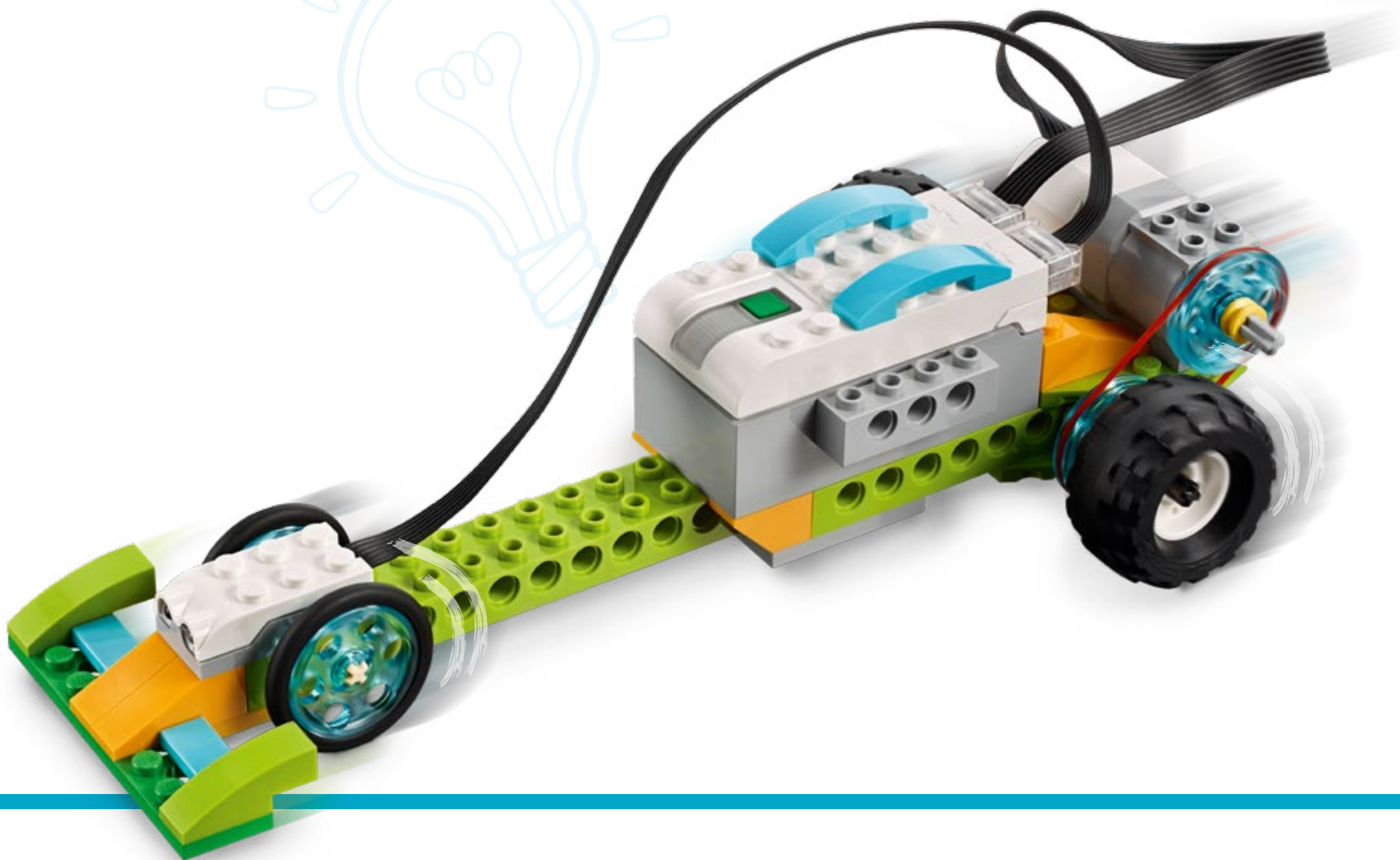
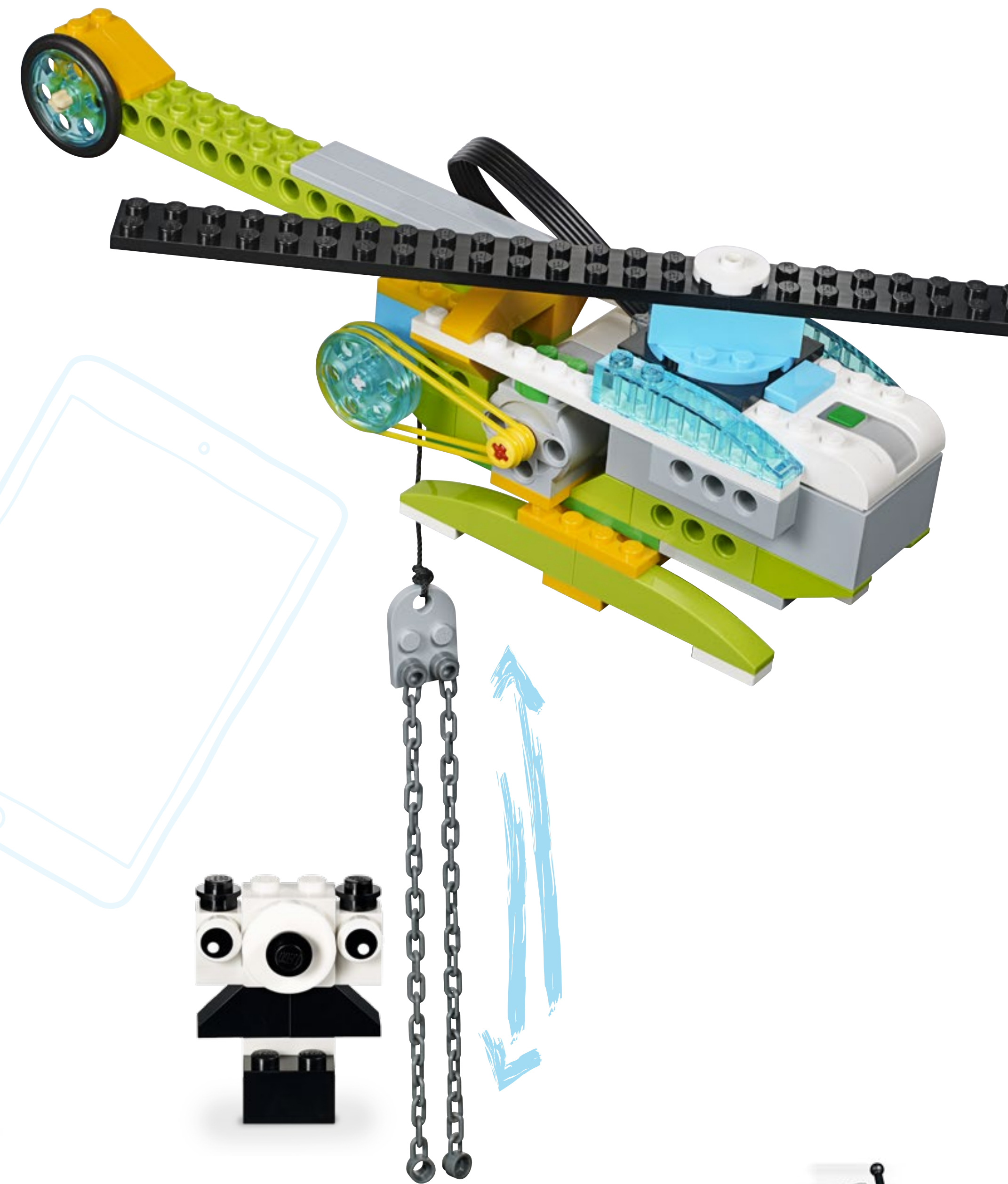

LEGOeducation.com

LEGO and the LEGO logo are trademarks of the/son des marques de commerce du/son marcas registradas de LEGO Group.
©2018 The LEGO Group. 20170101V2

