

3

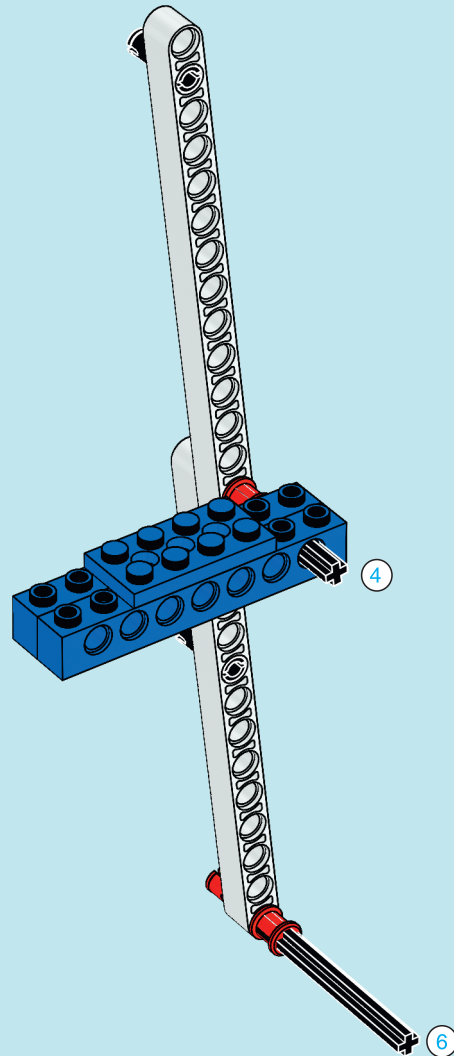

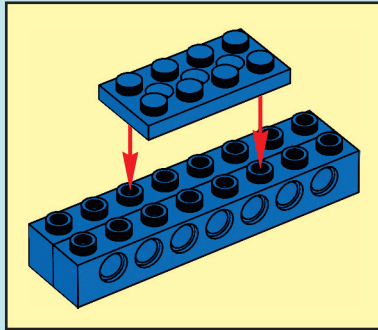

4

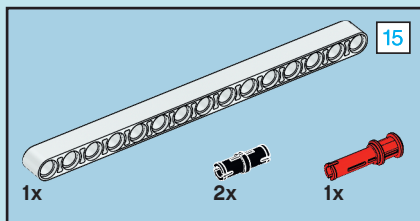
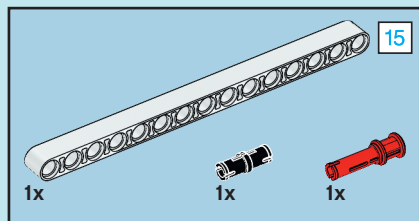
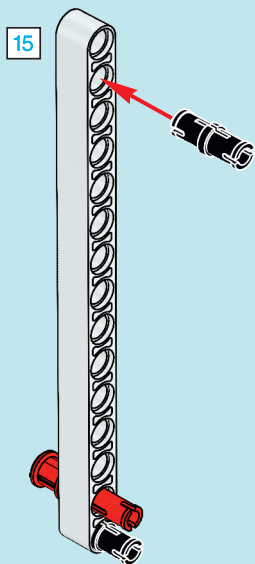

5

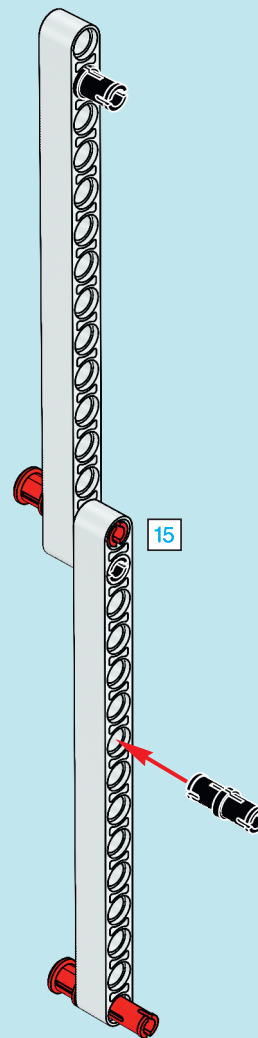



6

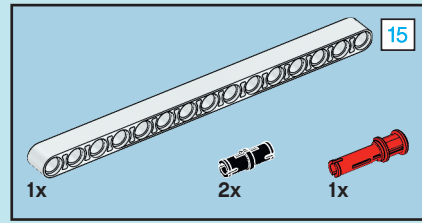
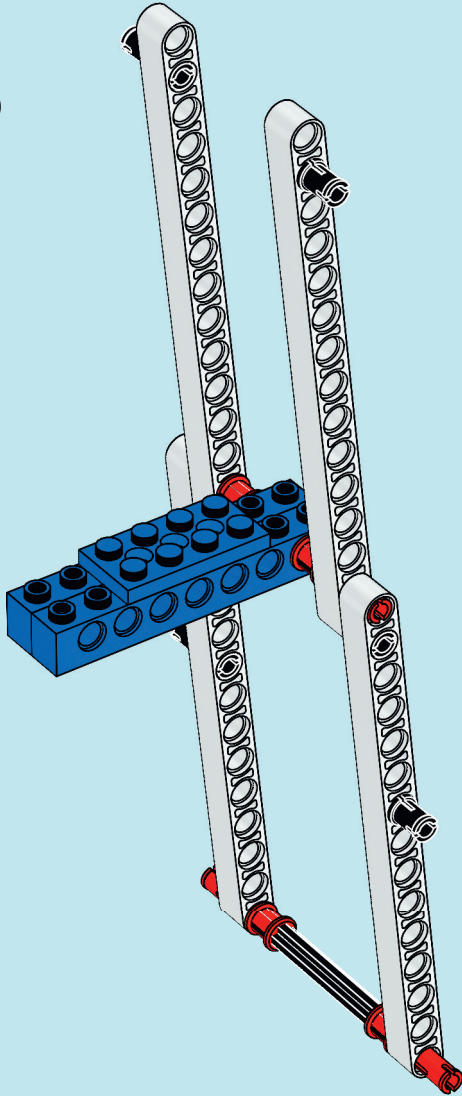

7

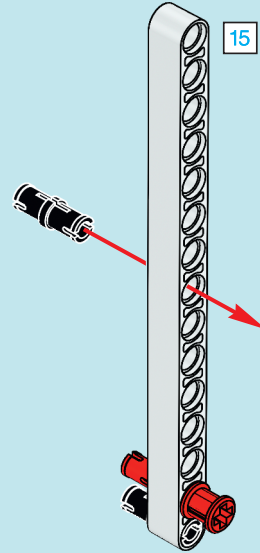

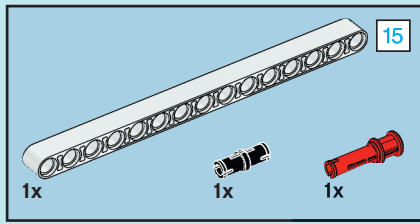

8

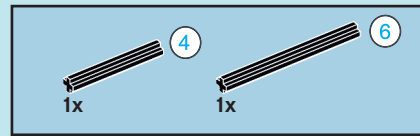
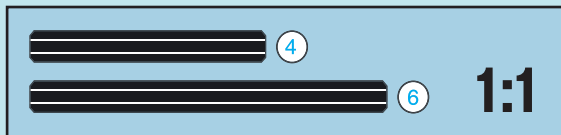
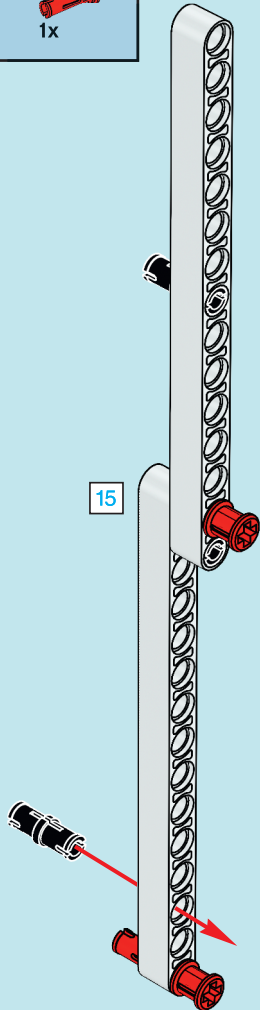

9

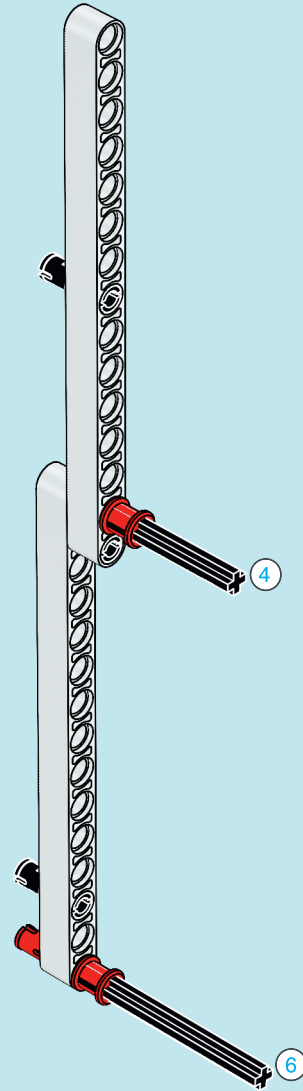

10

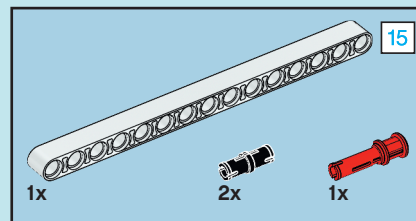
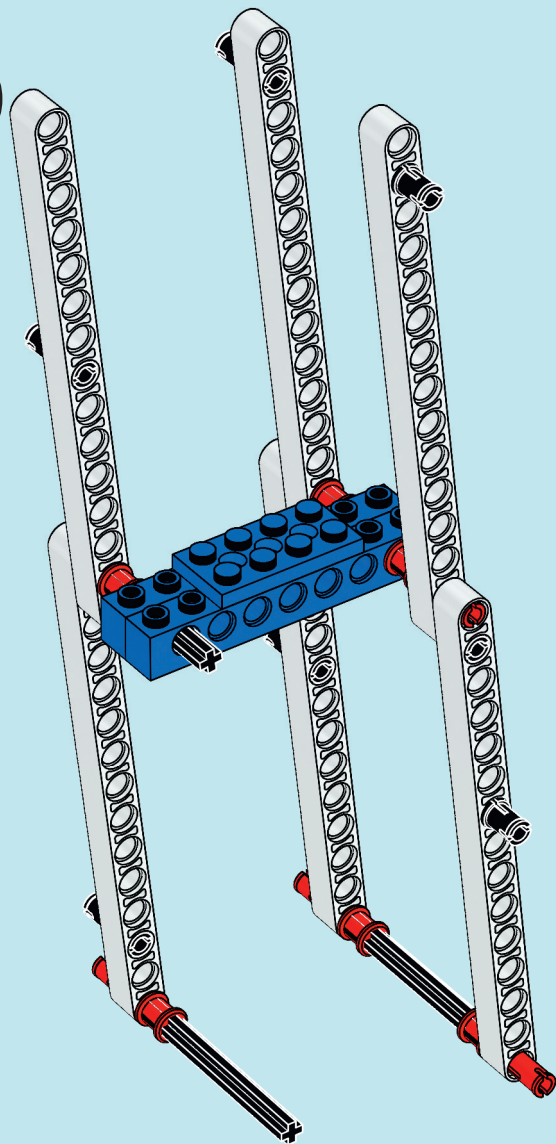

11

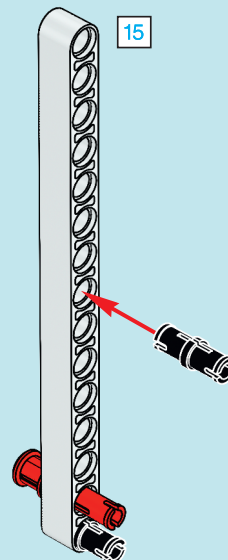

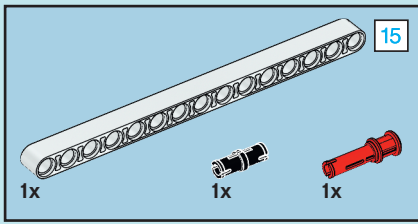

12

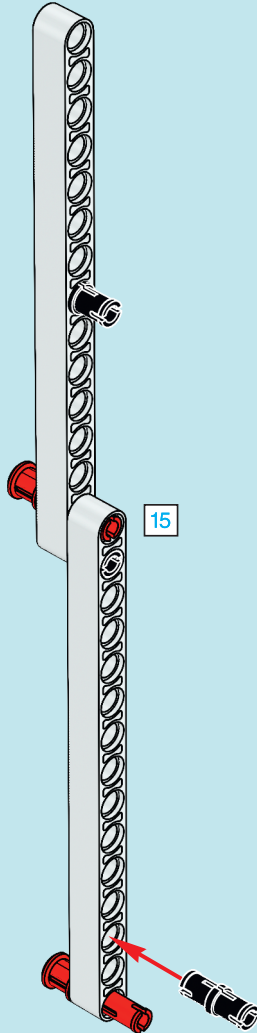

13

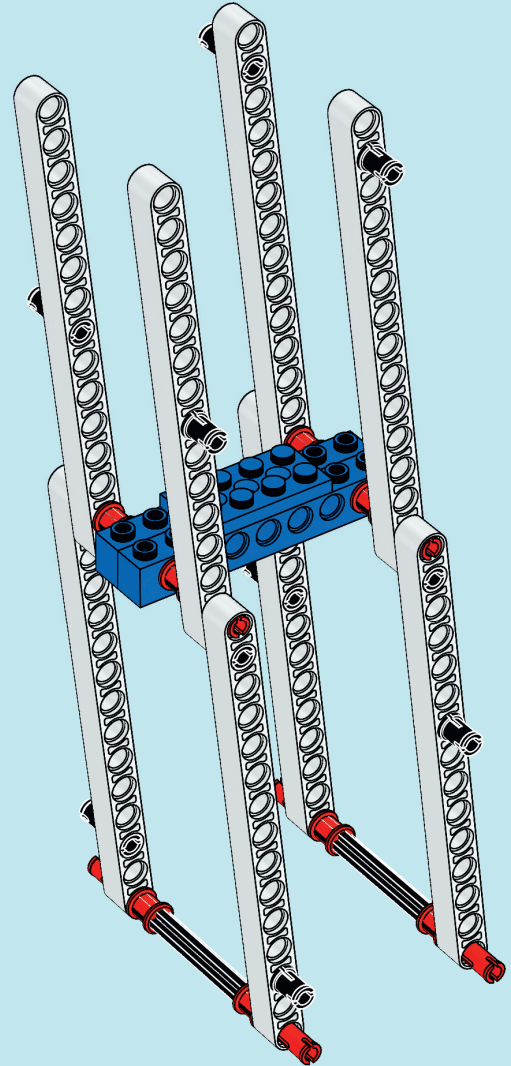

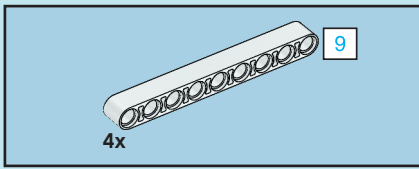

14

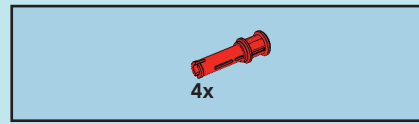
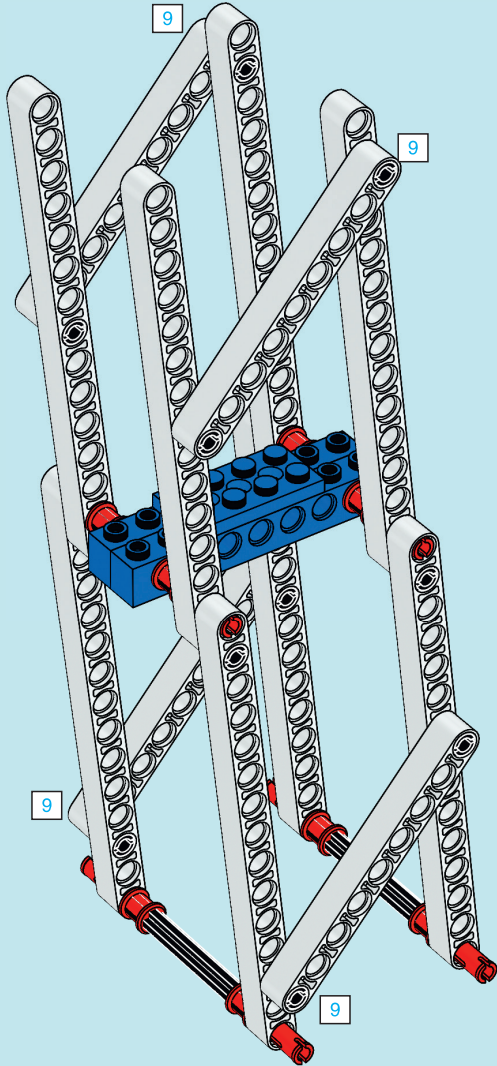

15

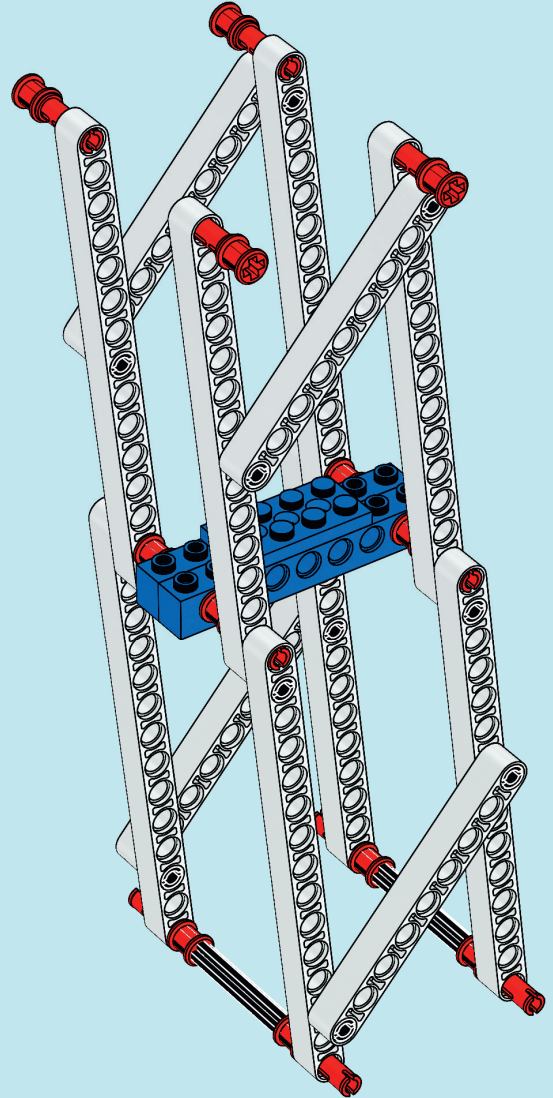

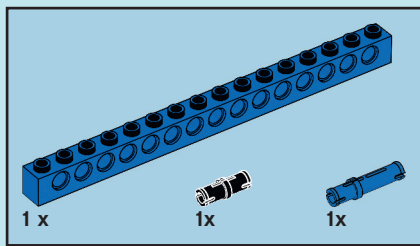

16

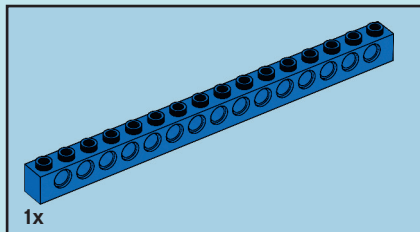
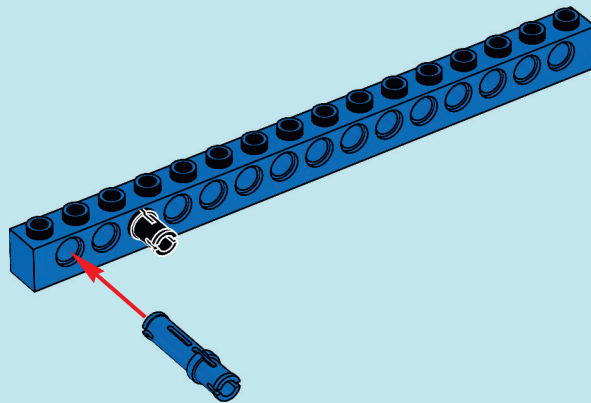

17

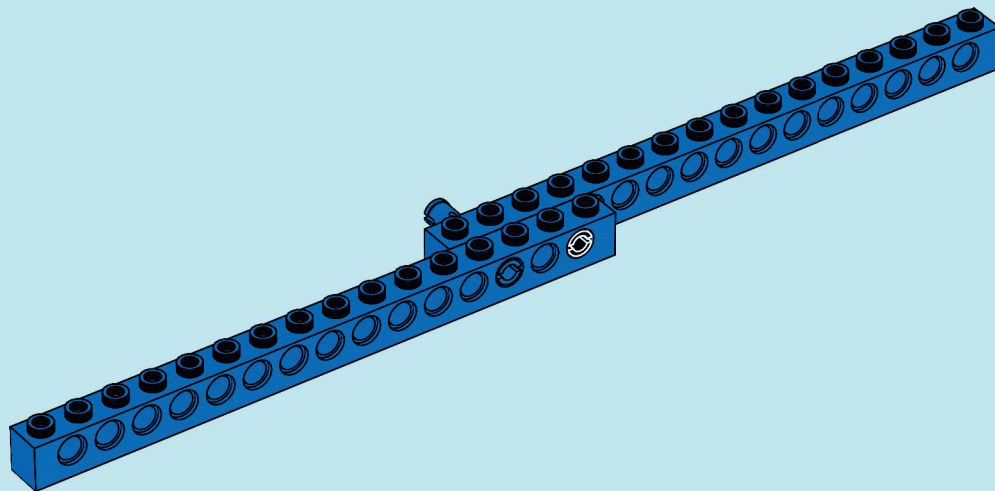



18

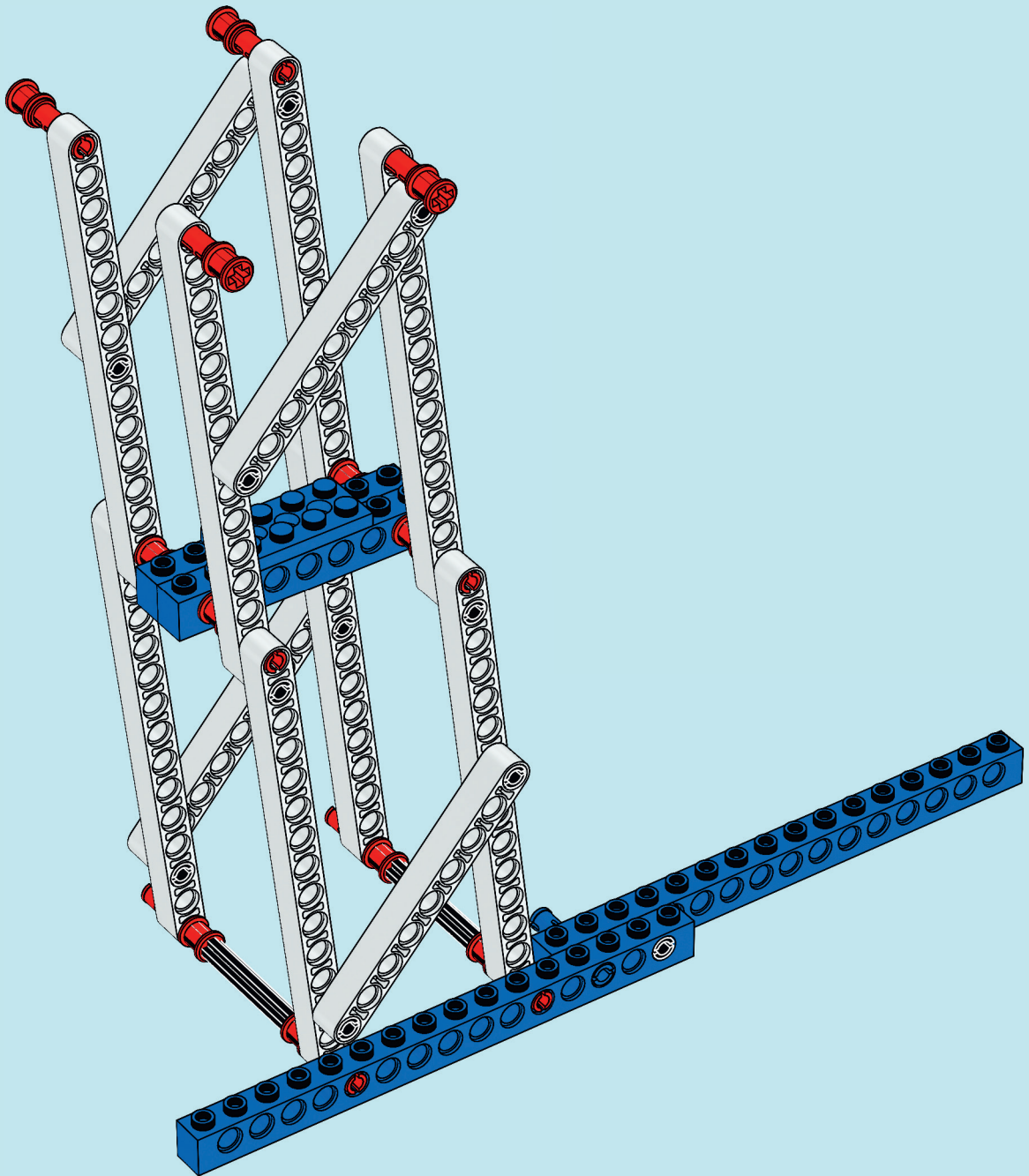

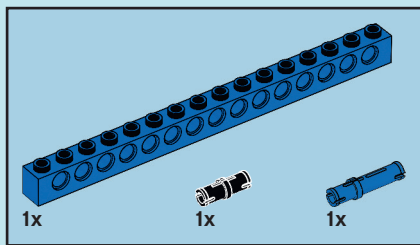

19

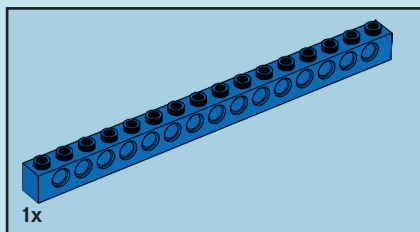
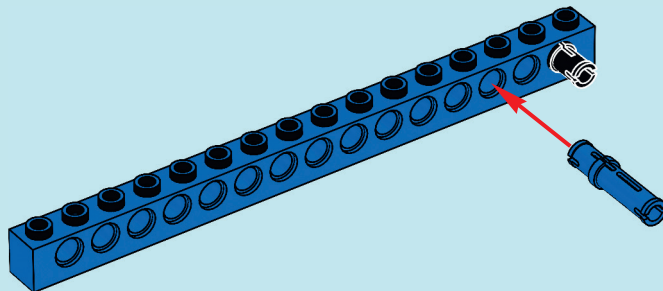

20

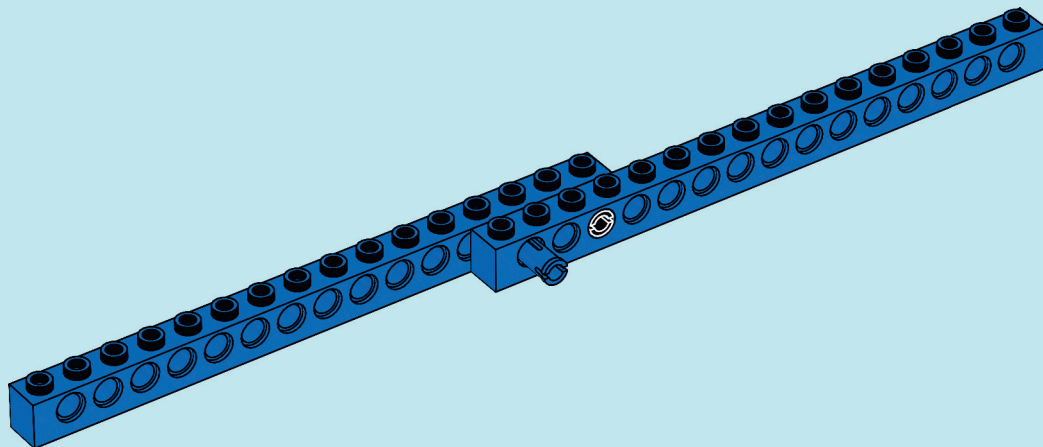



21

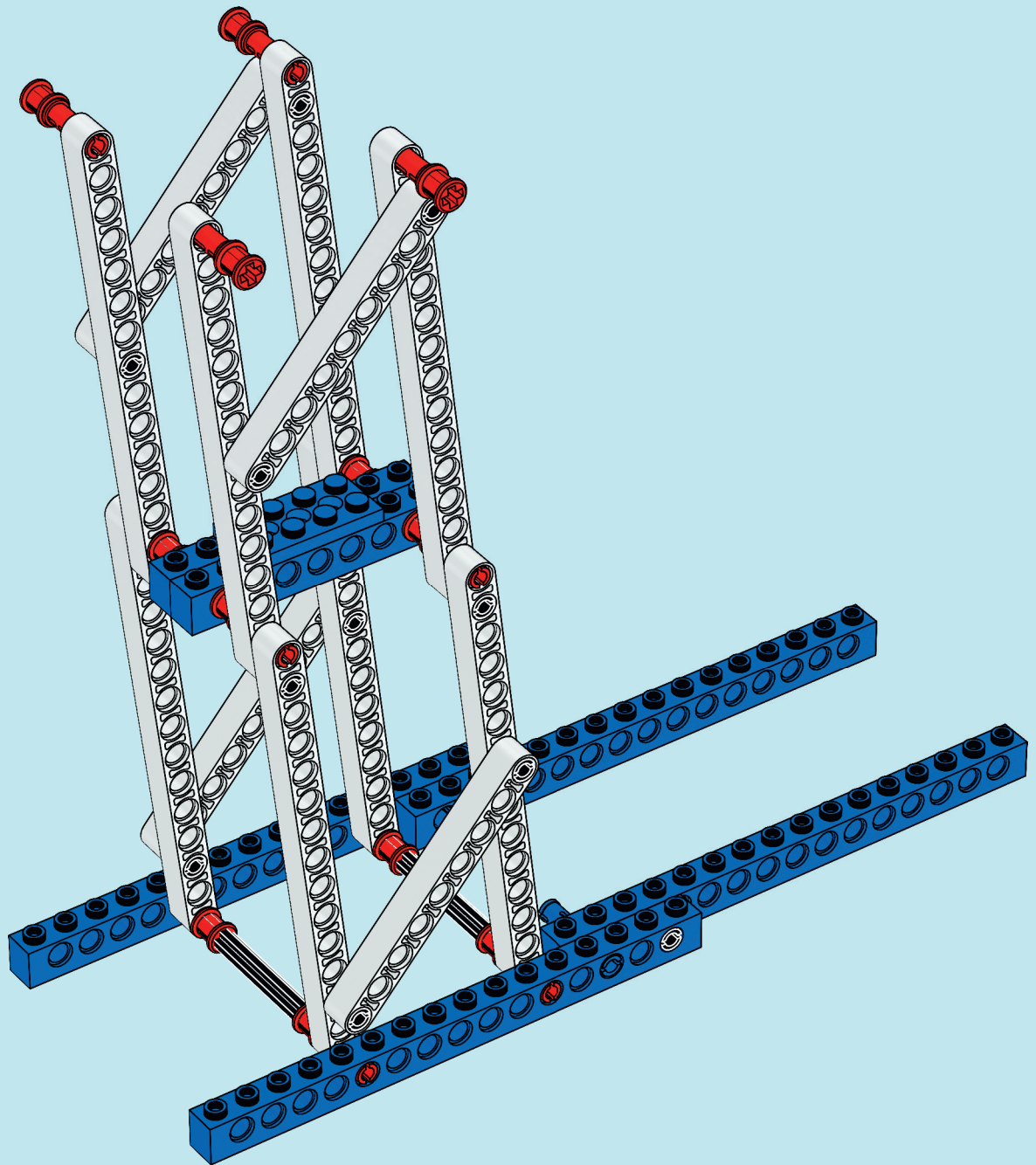

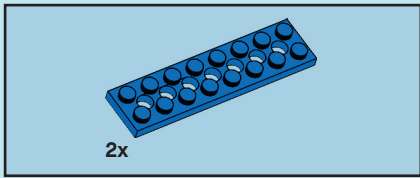

22

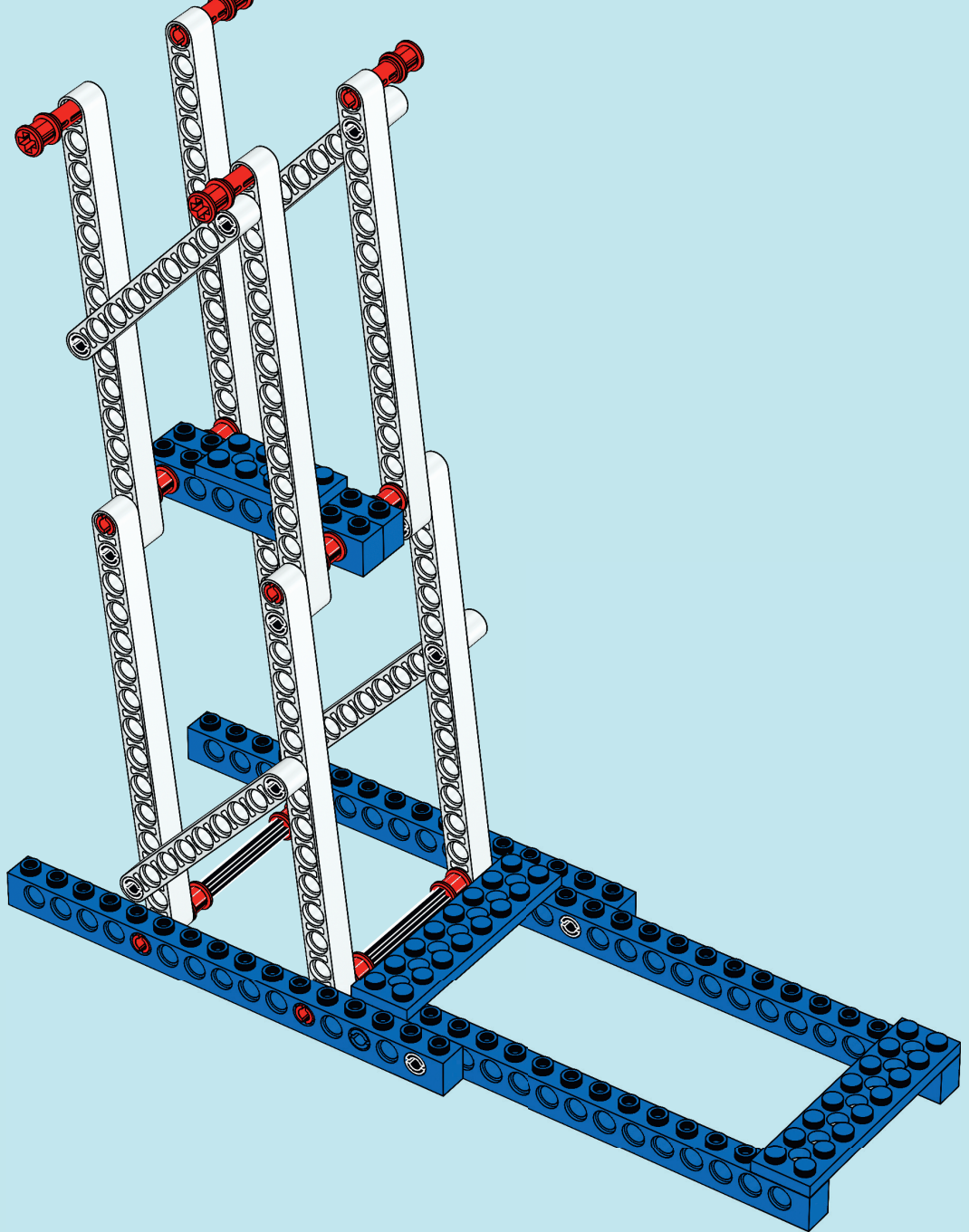

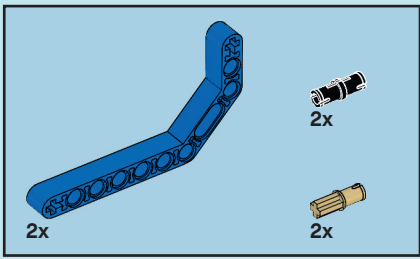

23

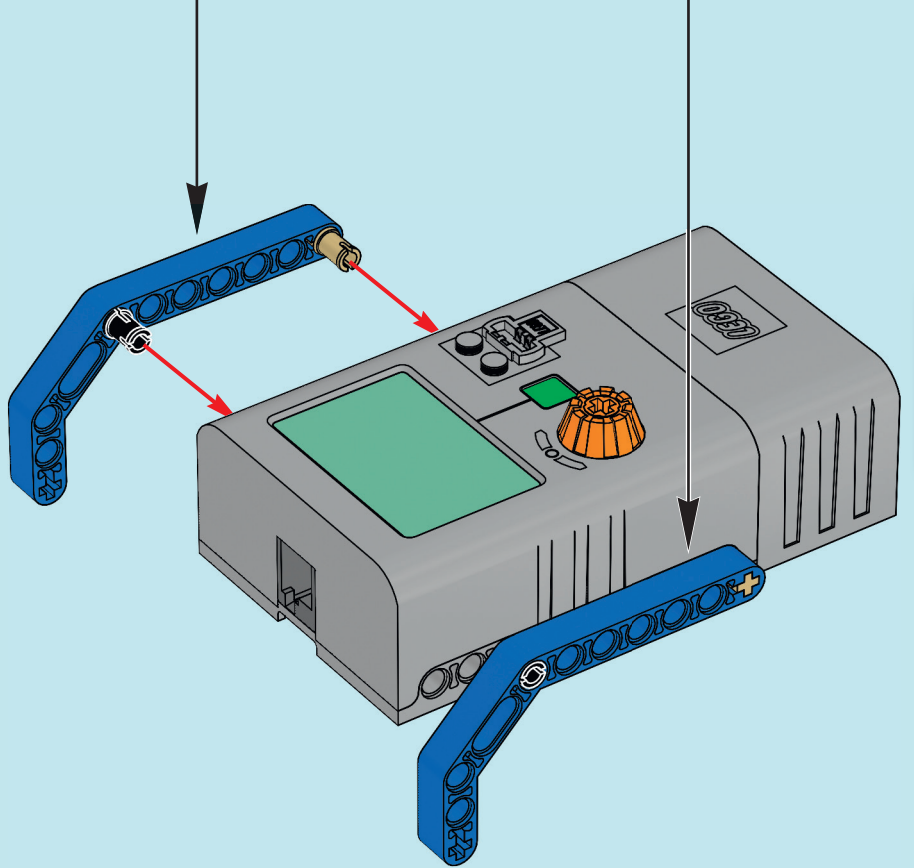
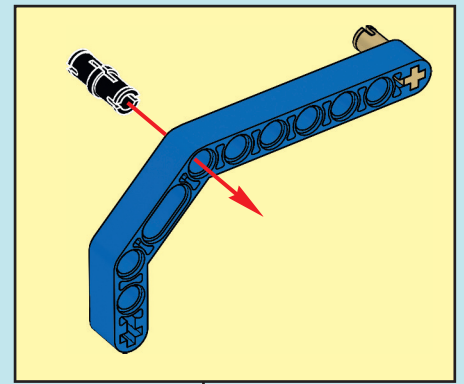
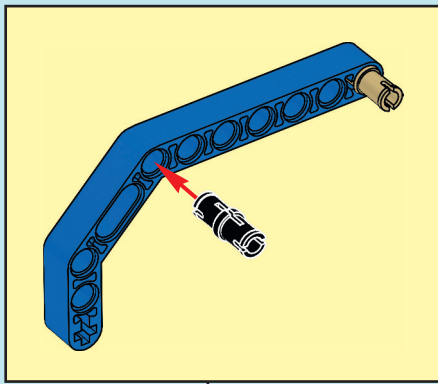

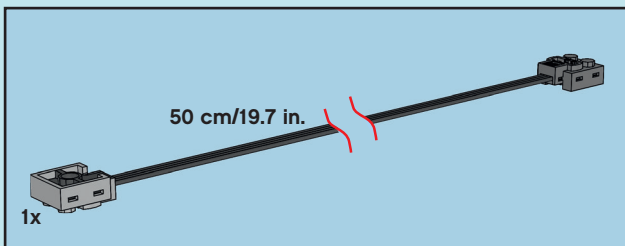

24

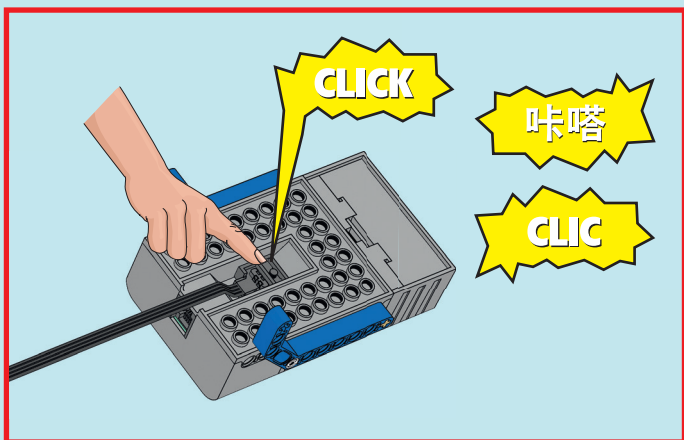
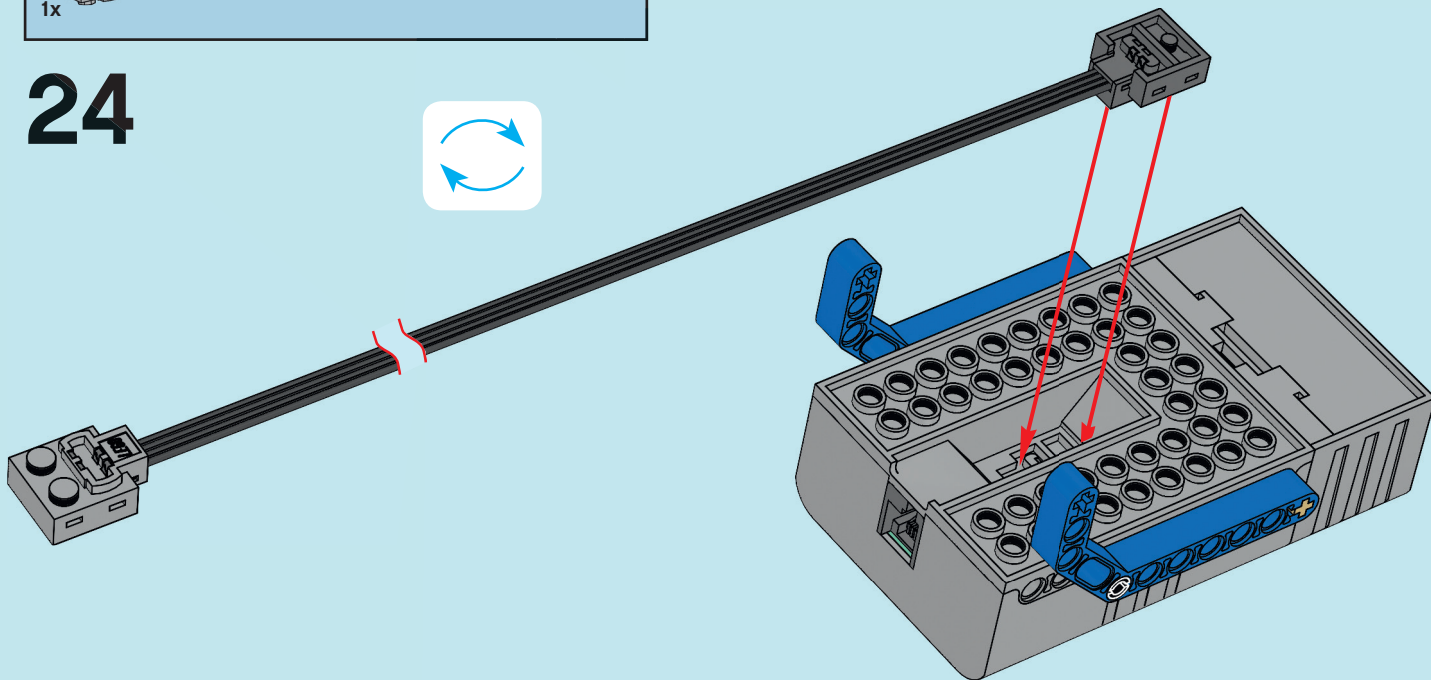

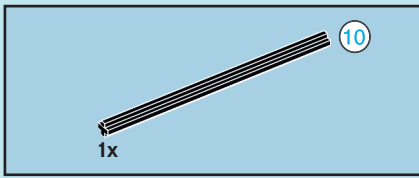

25

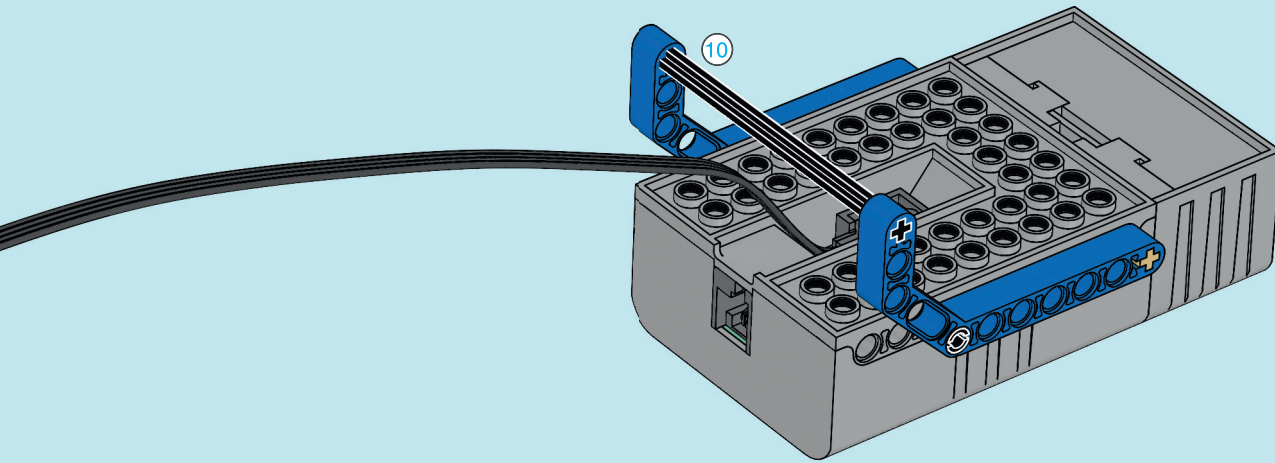



26

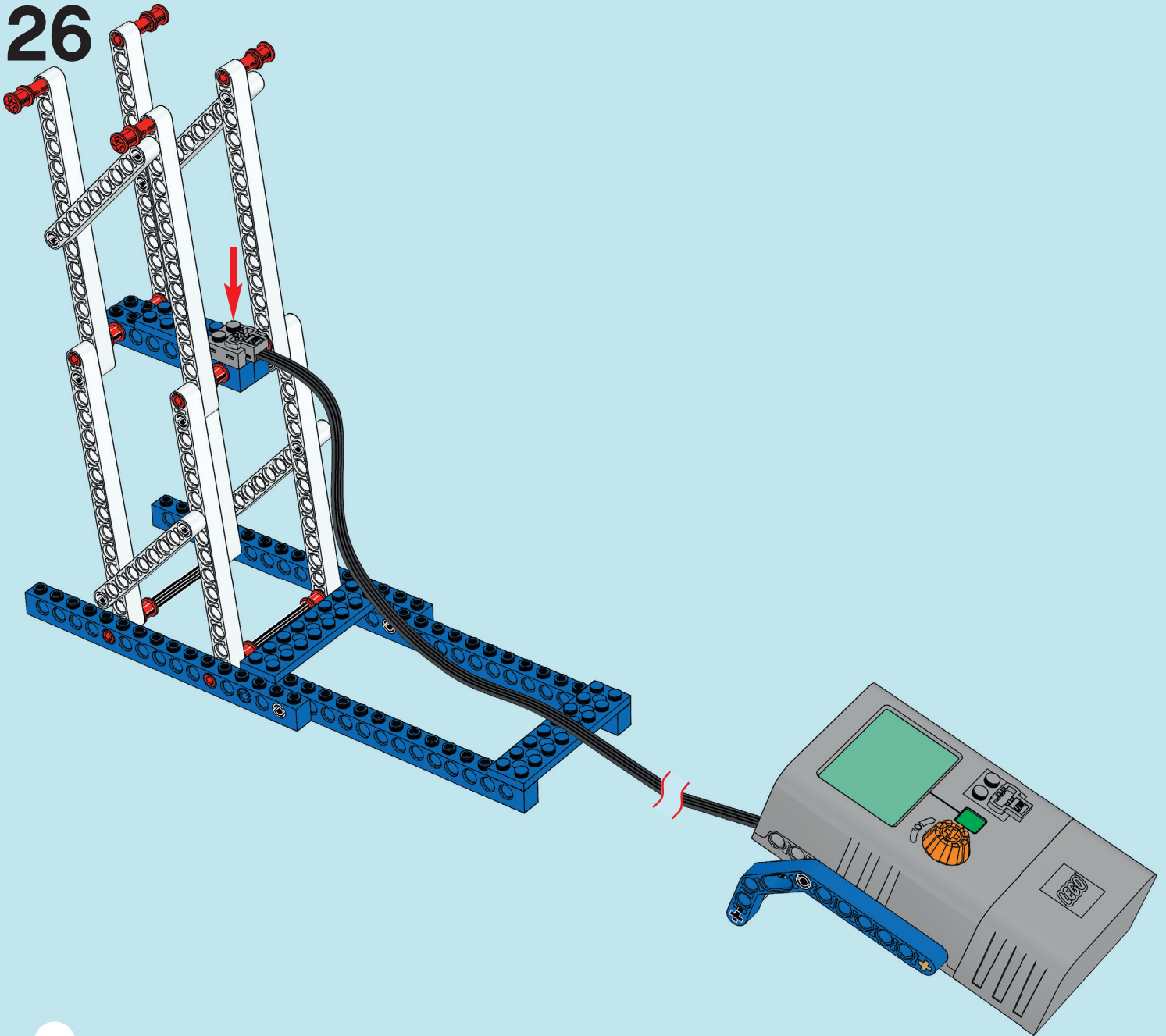

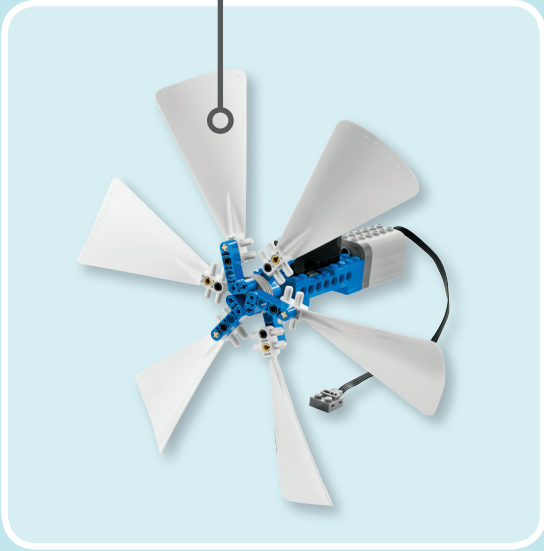
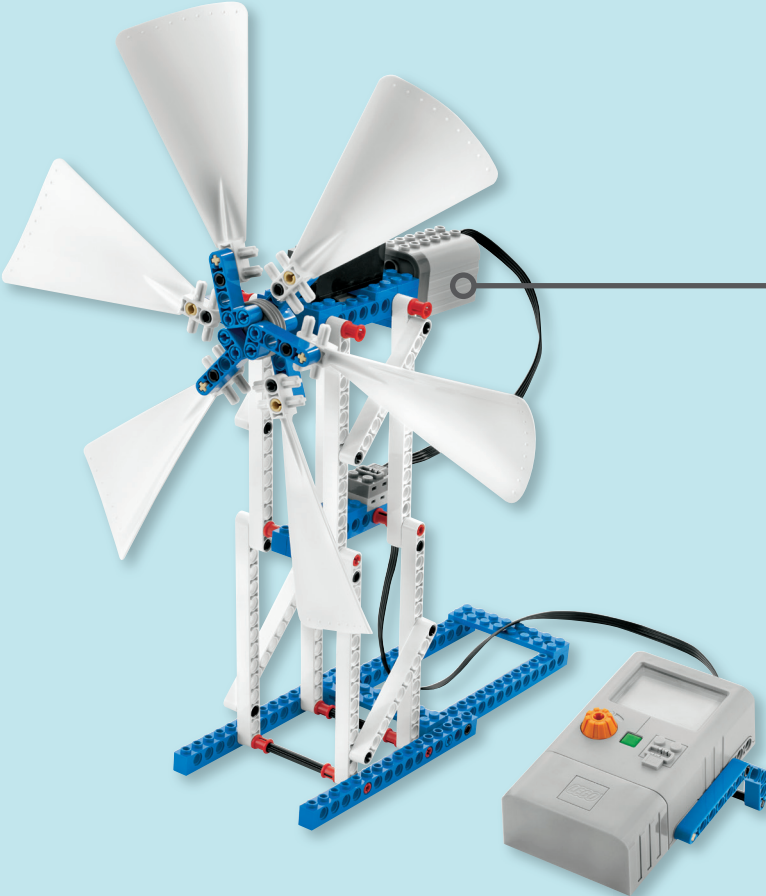

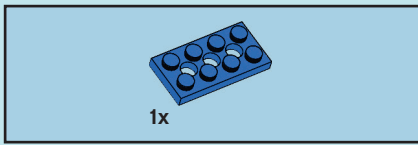

1

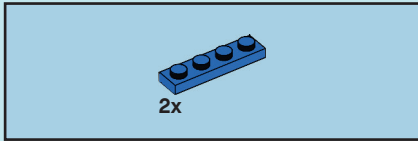
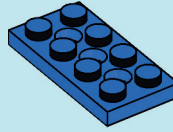

2

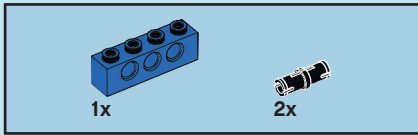
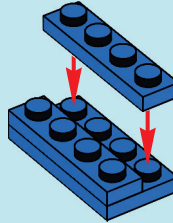

3

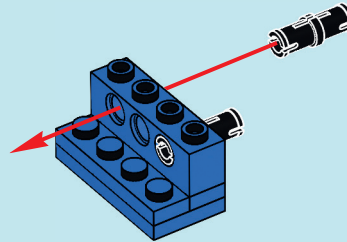



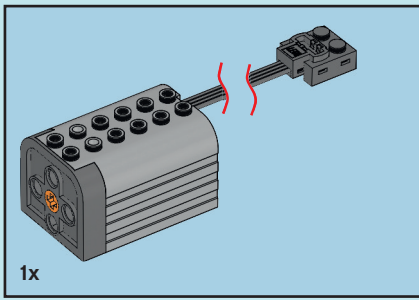

4

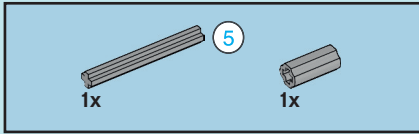
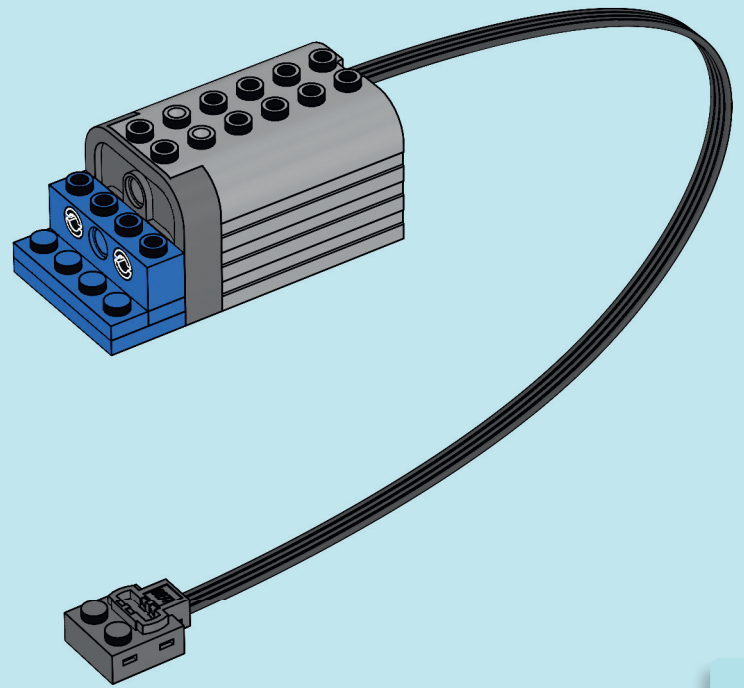

5

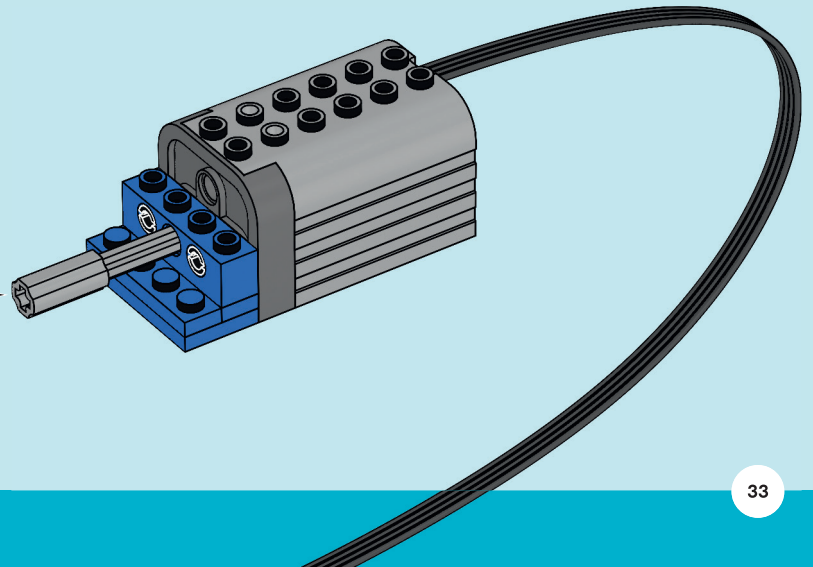
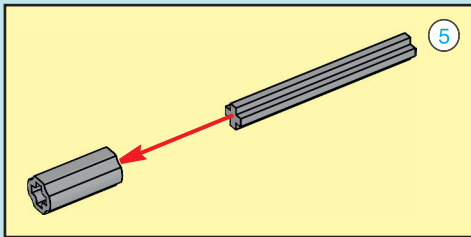

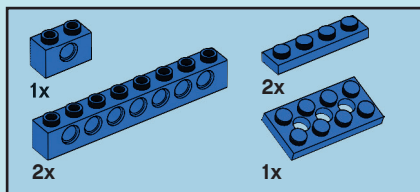

6

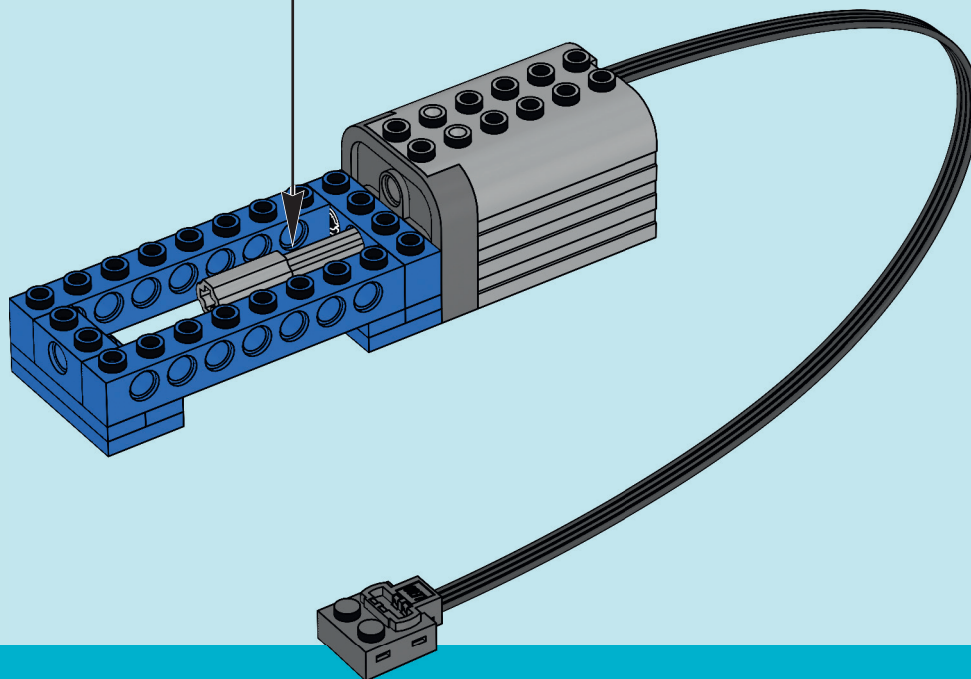
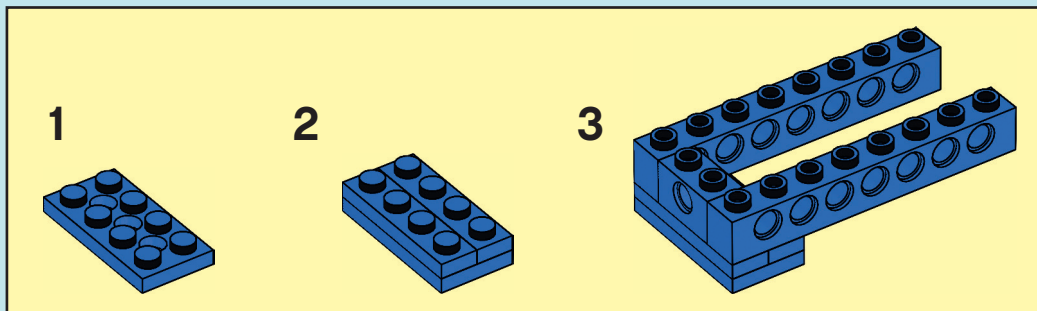

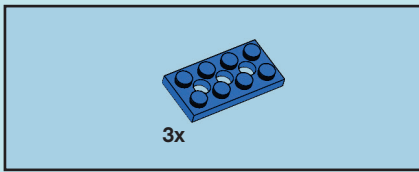

7

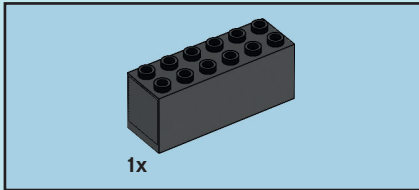
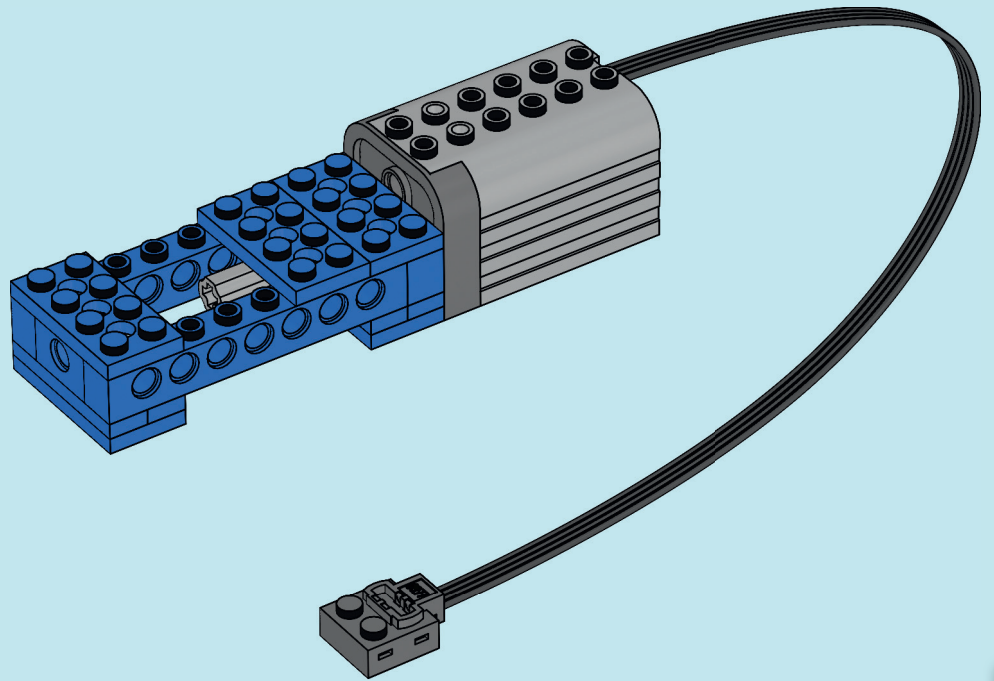

8

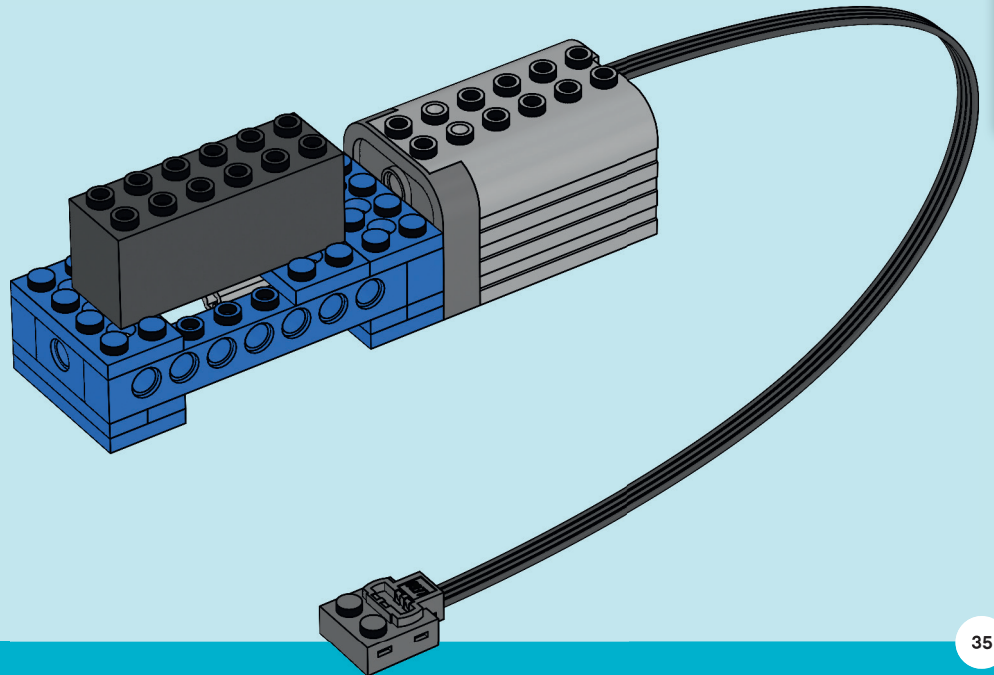

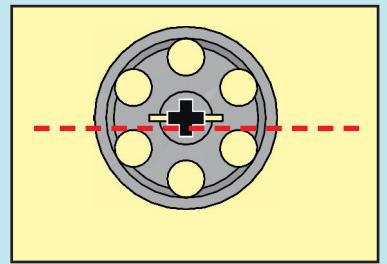
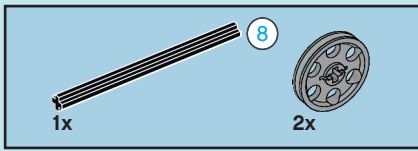

9

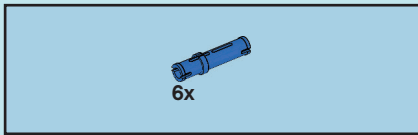
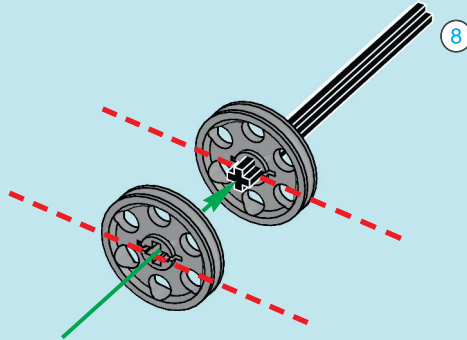

10

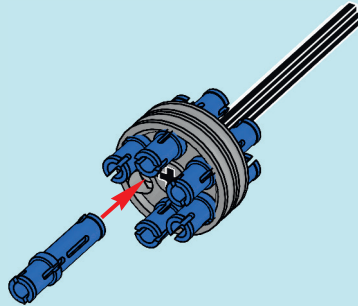

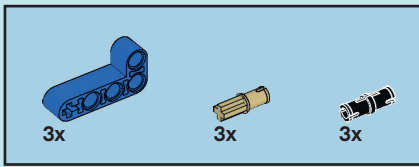

# 11

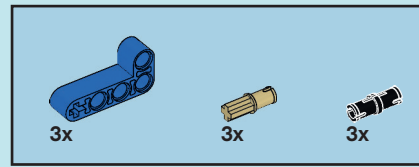
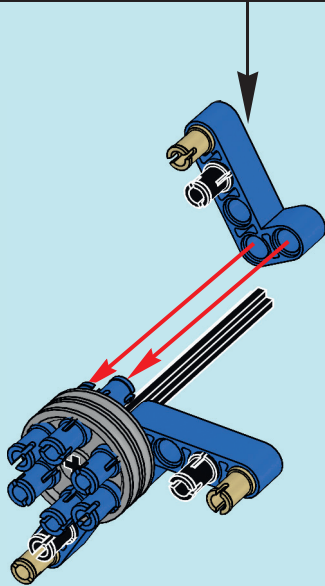
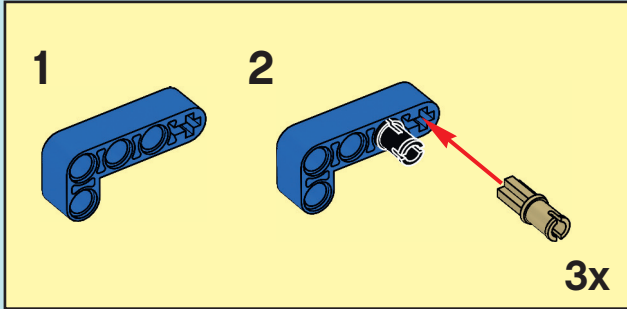

# 12

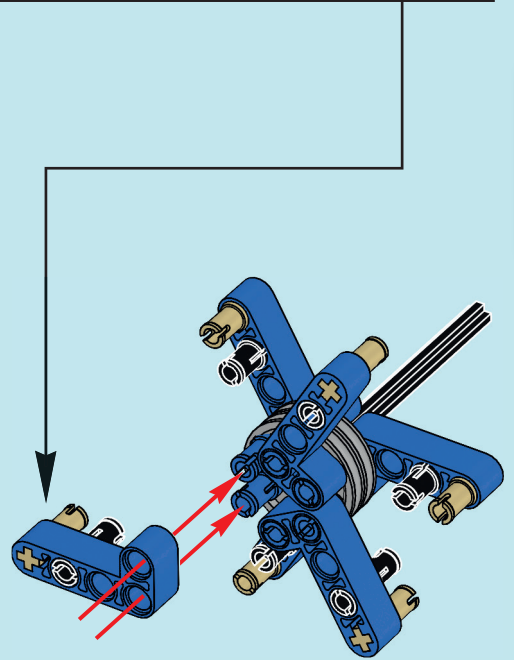
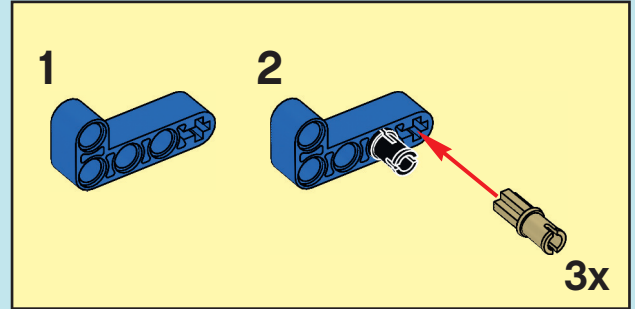

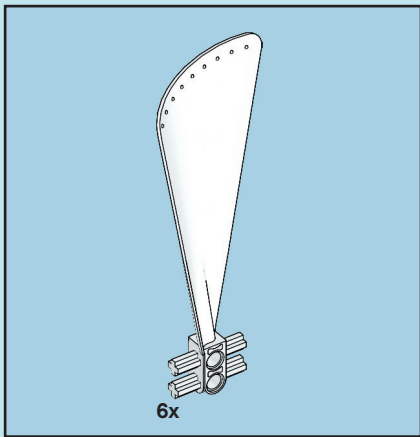

13

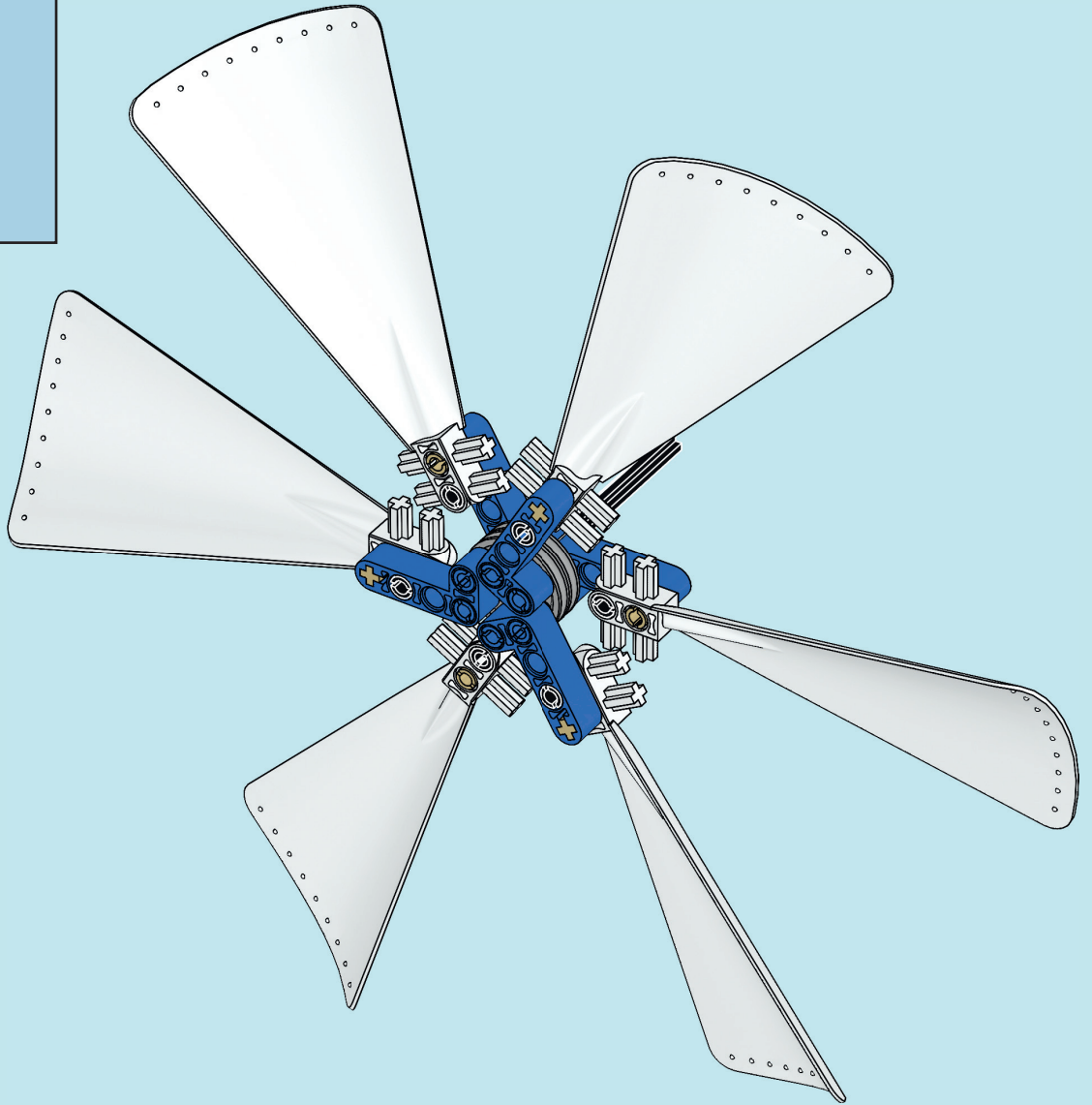



1x

# 14

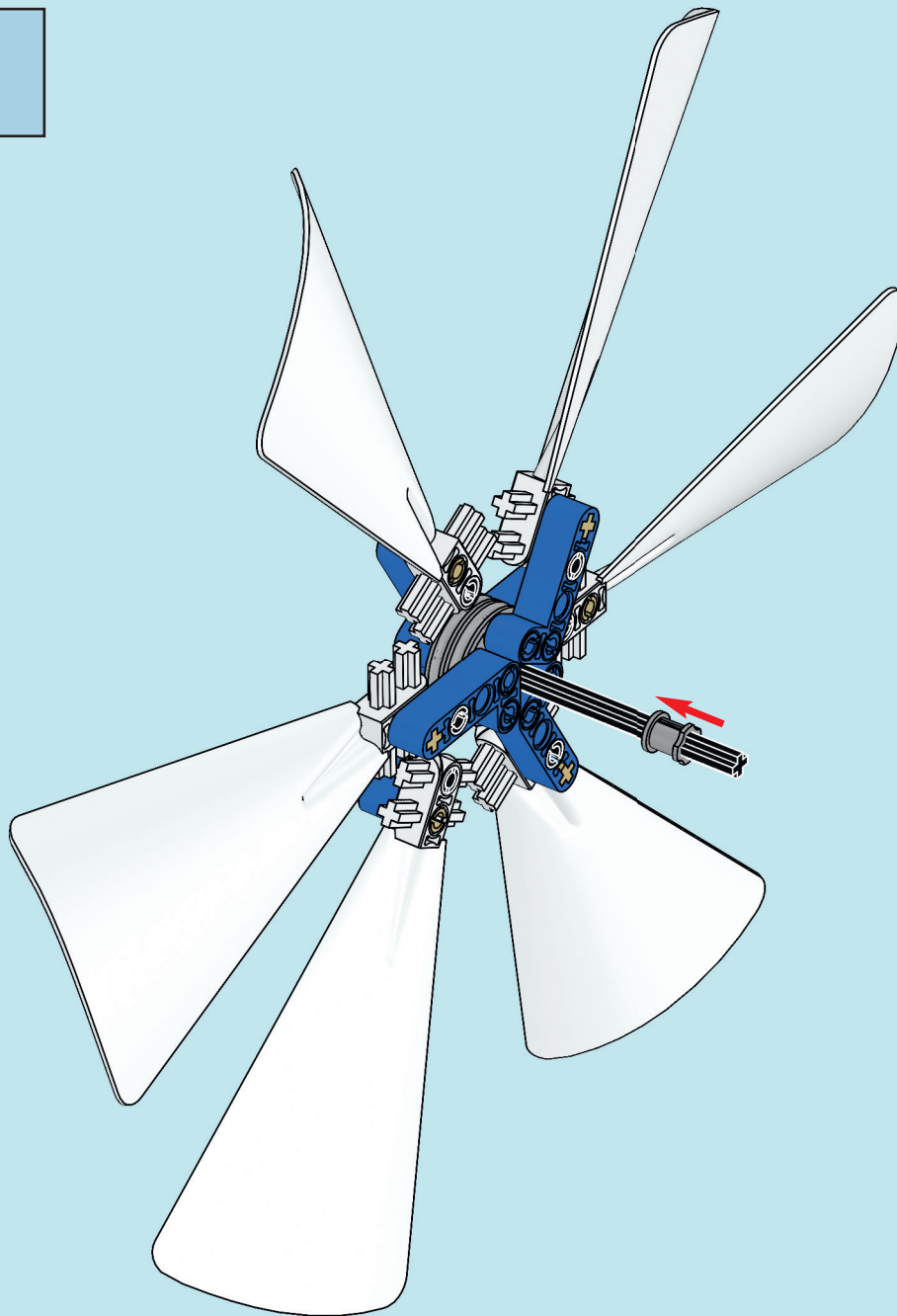



15

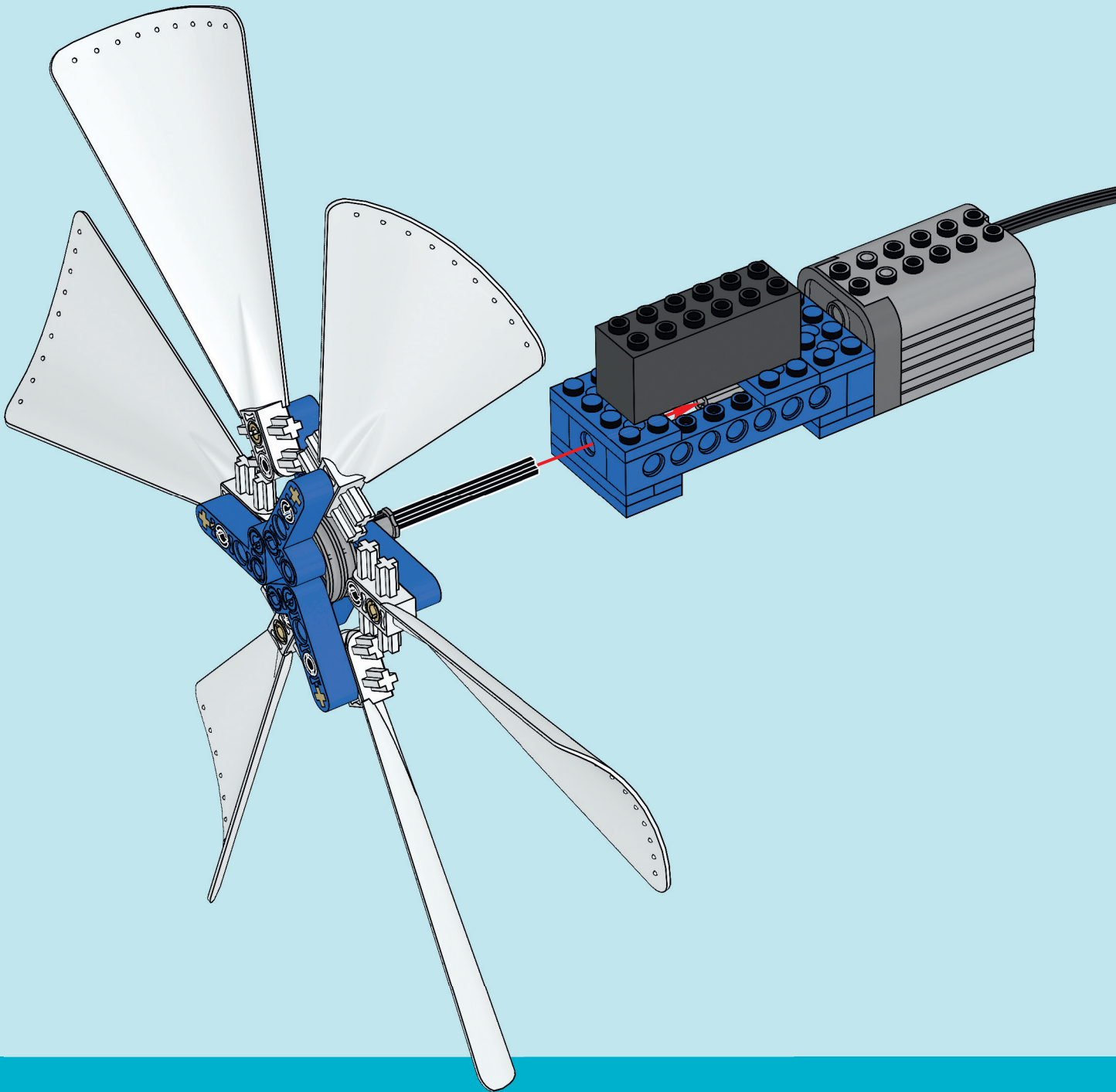



16

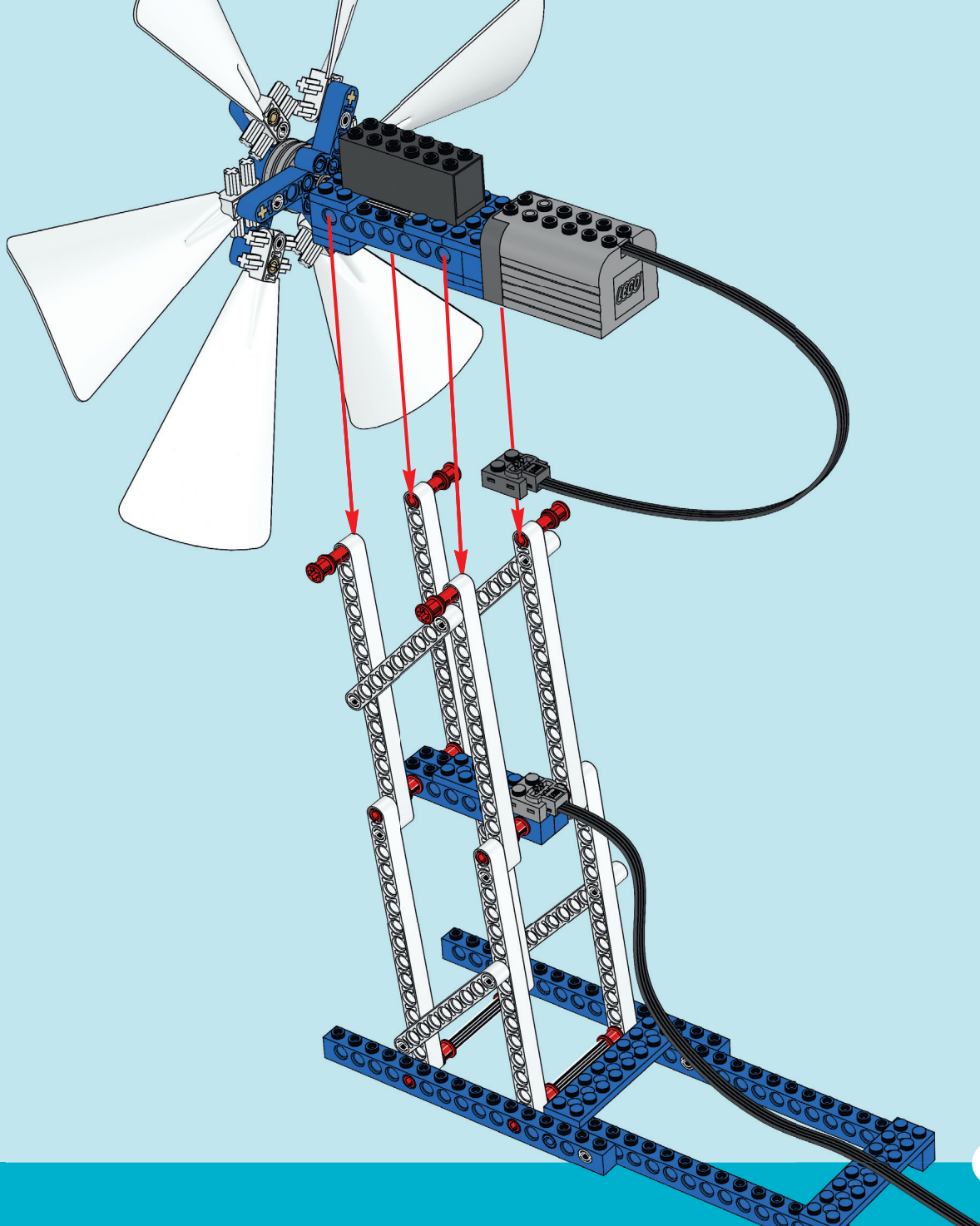

17

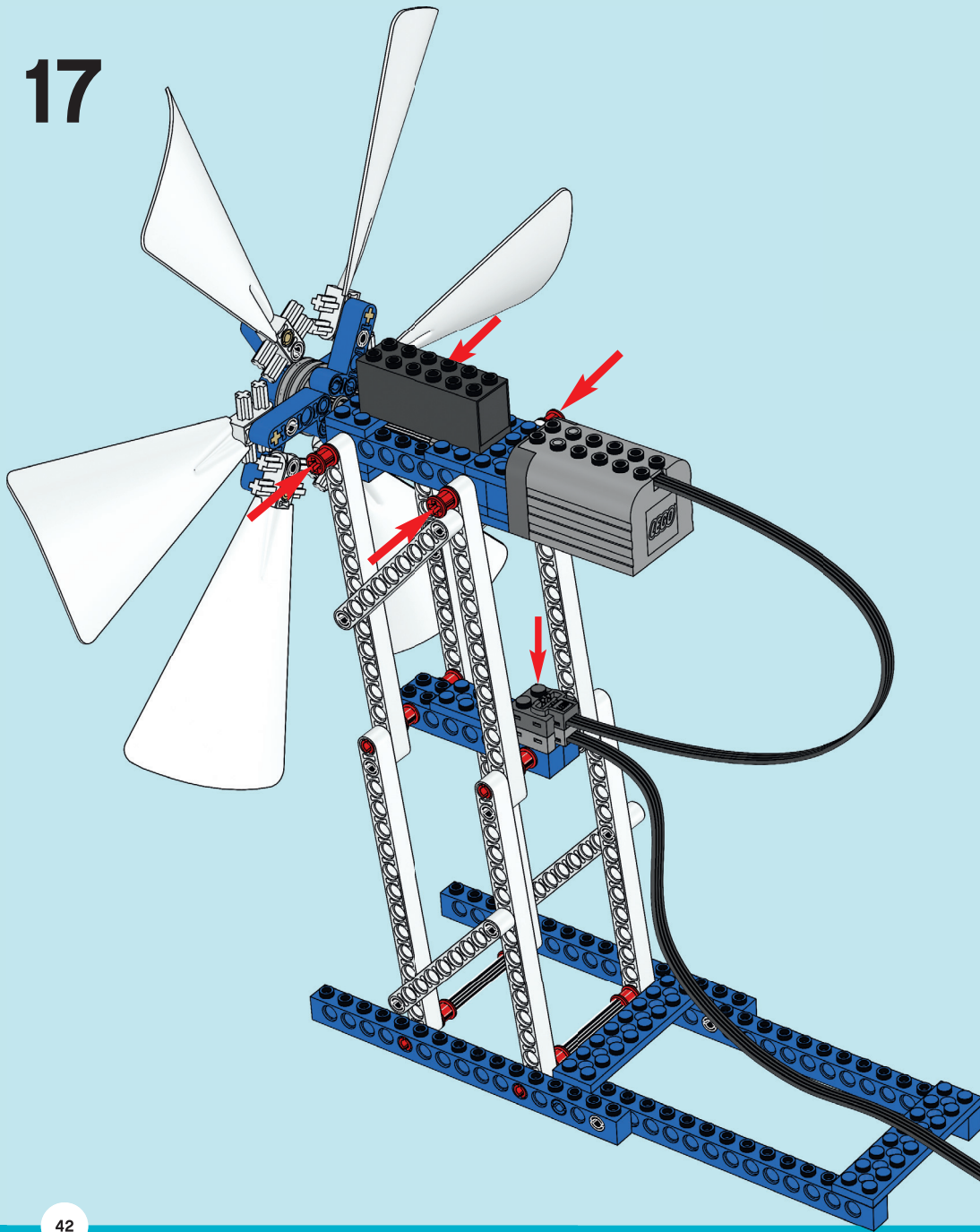

# 18

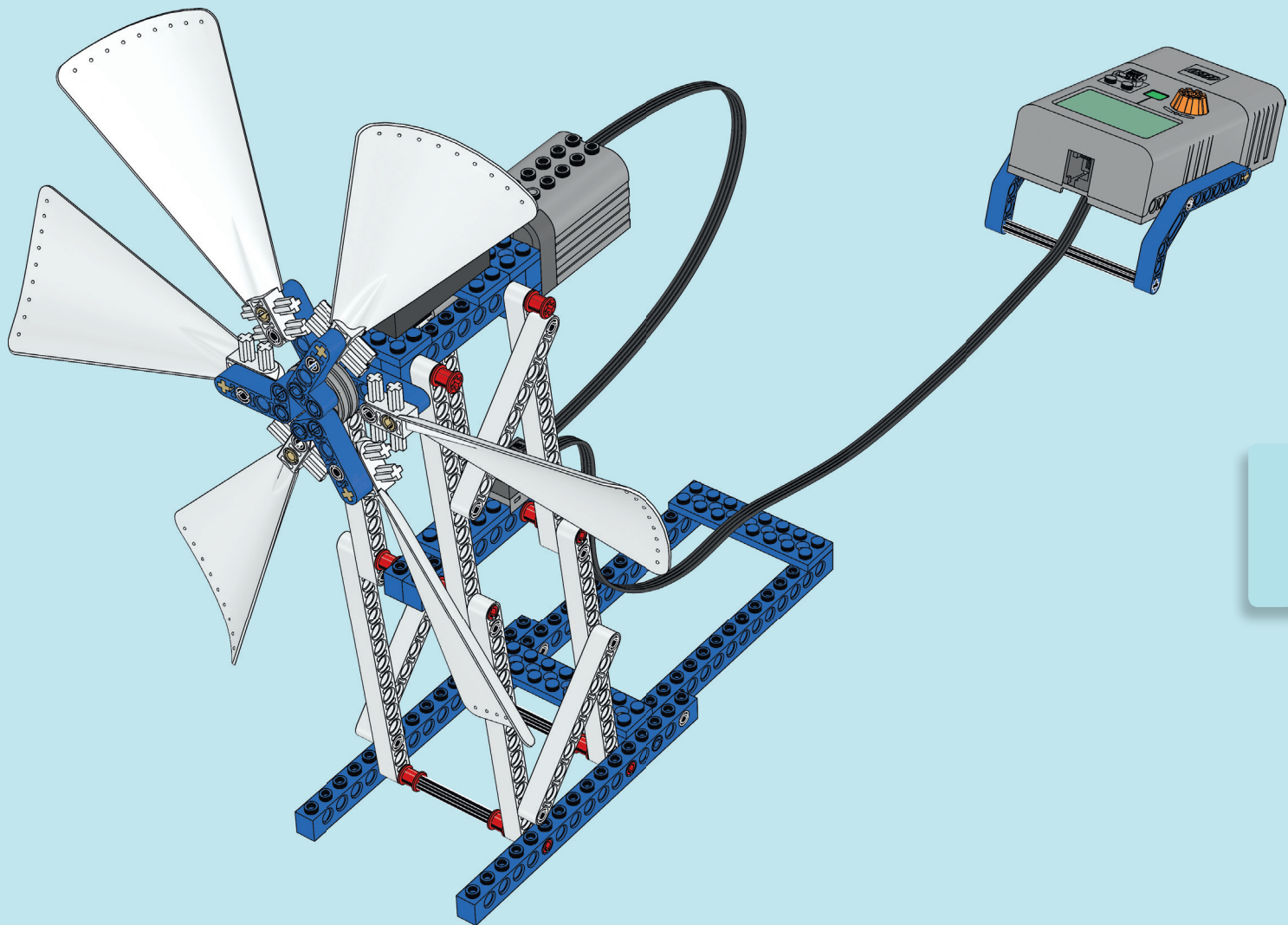

1

