

LEGO® Education WeDo 2.0

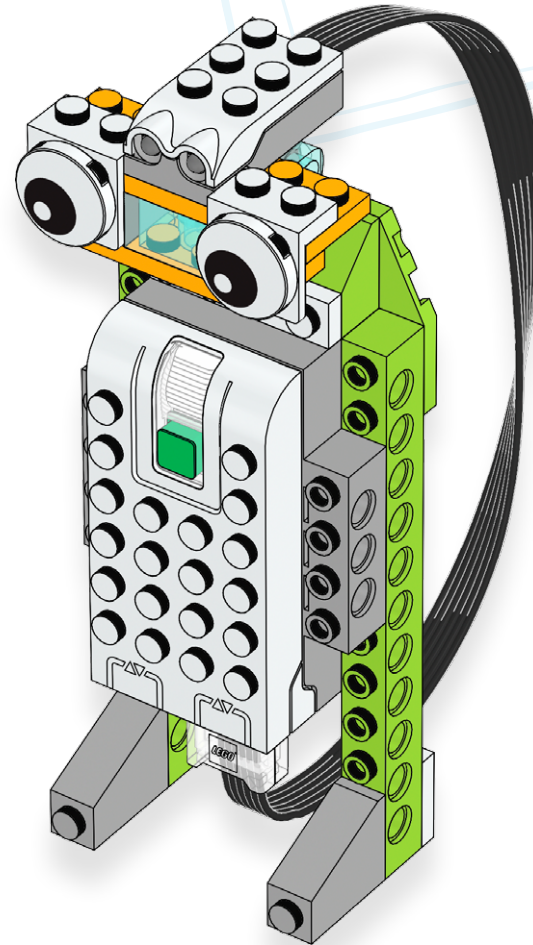

45300

LEGO and the LEGO logo are trademarks of the/sonit des marques de commerce
du/son marcas registradas de LEGO Group. ©2015 The LEGO Group. 088360.





45300

LEGO and the LEGO logo are trademarks of the/son des marques de commerce
du/son marcas registradas de LEGO Group. ©2015 The LEGO Group. 088360.



education

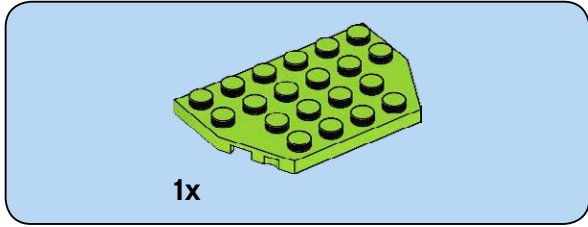

1

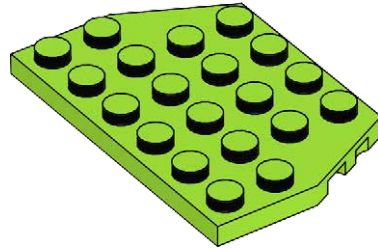

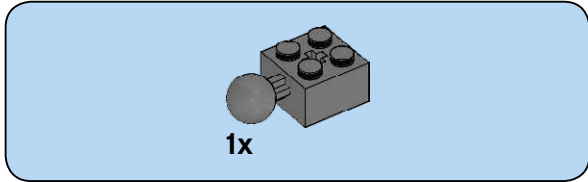

2

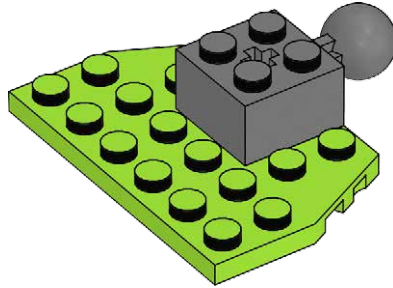

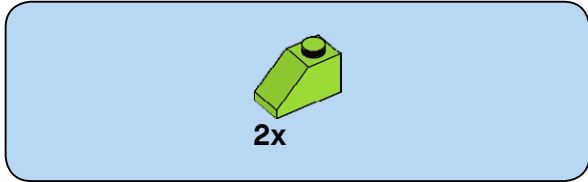

3

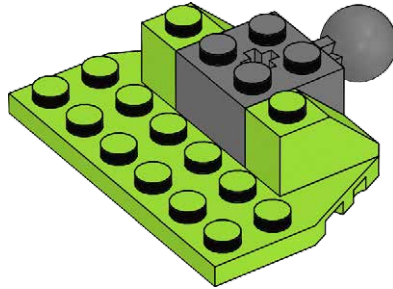

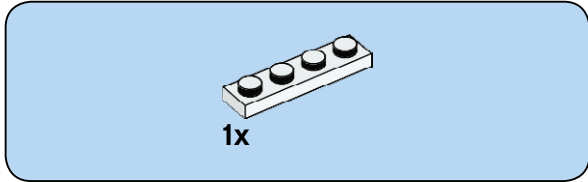

4

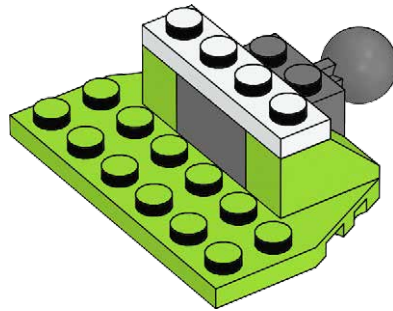

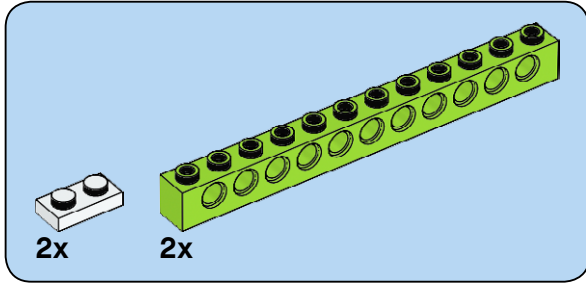

5

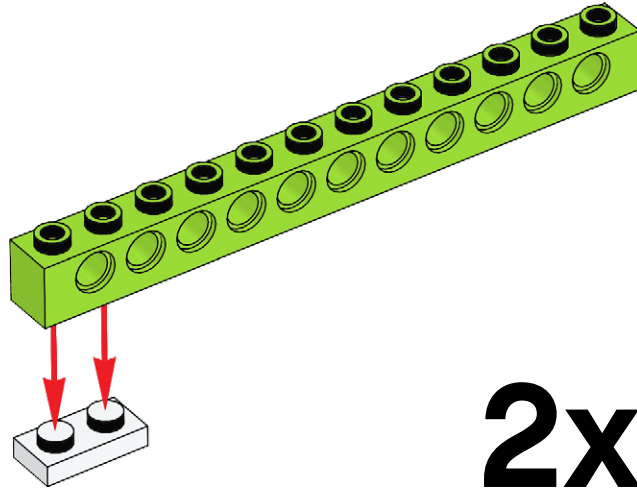

6

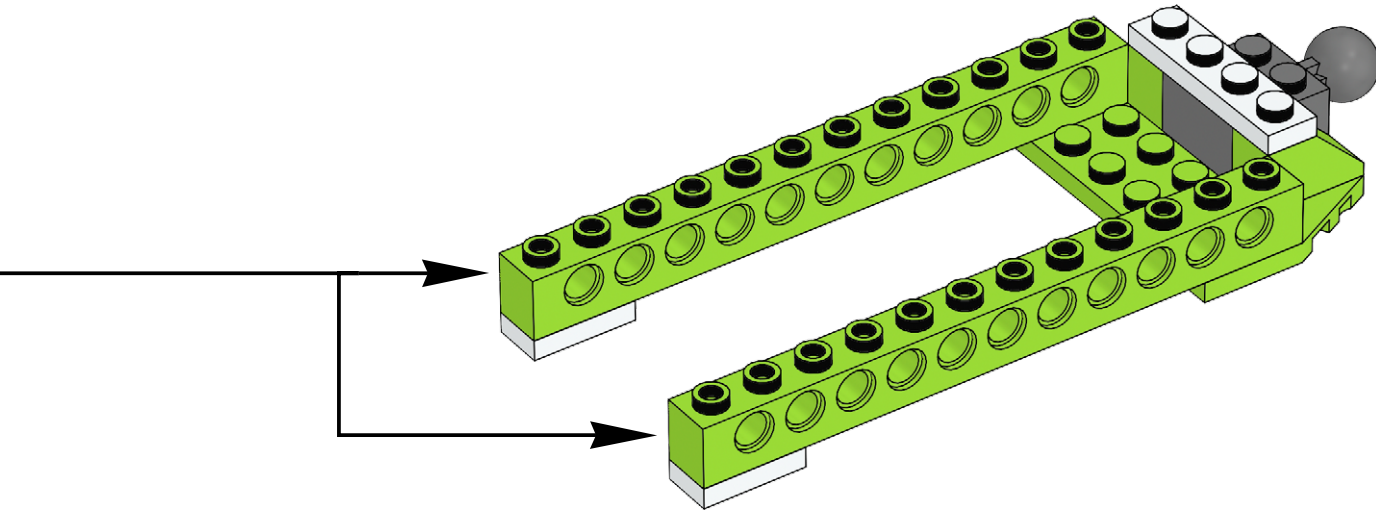

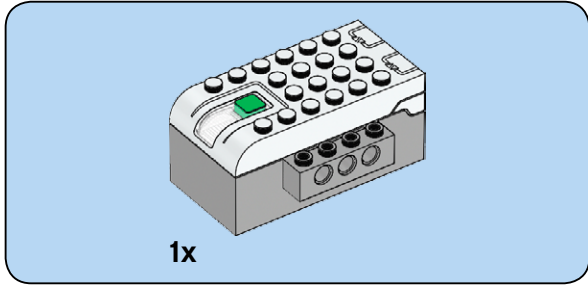

7

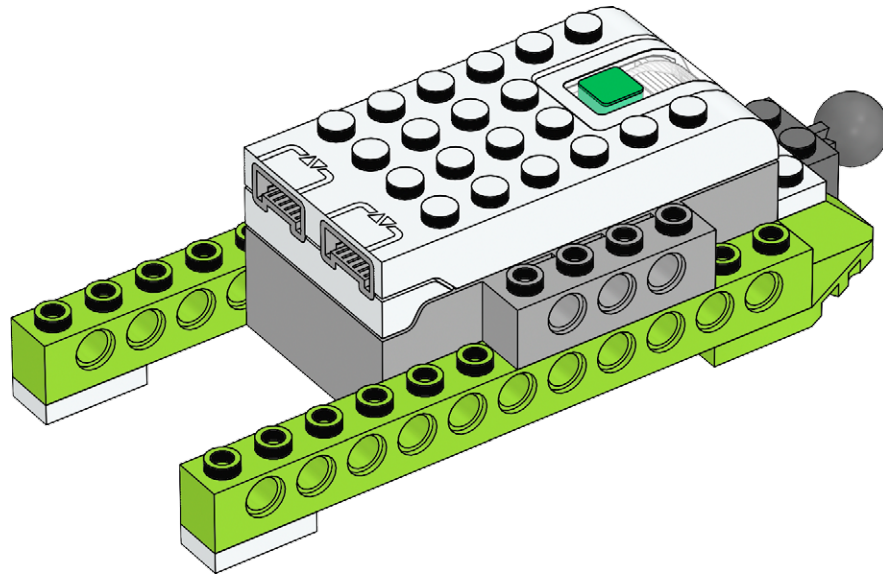

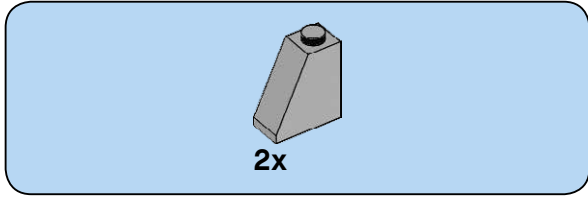

8

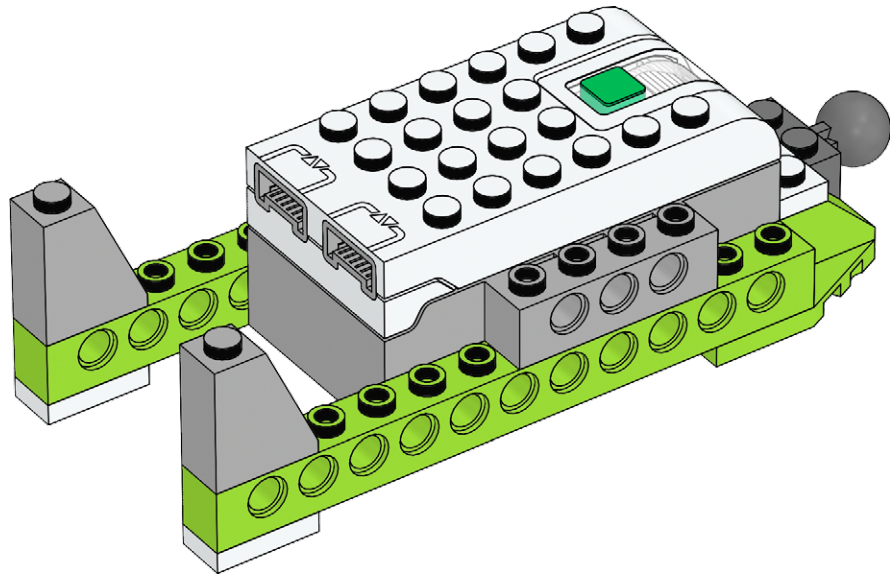

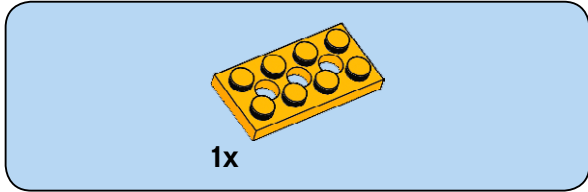

9

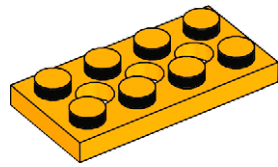

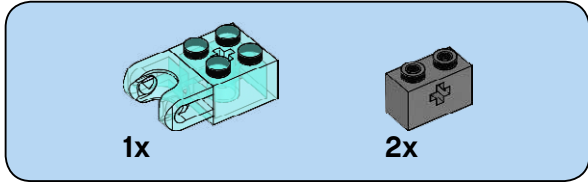

10

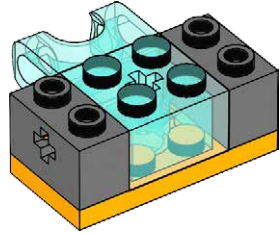

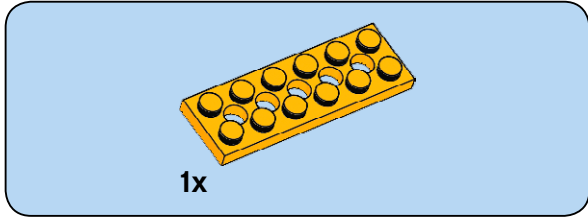

11

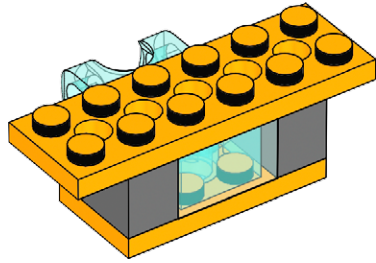

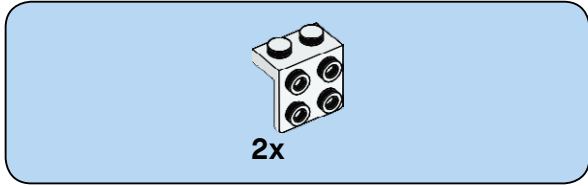

12

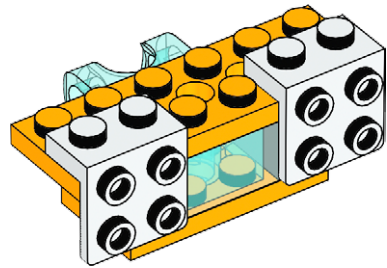

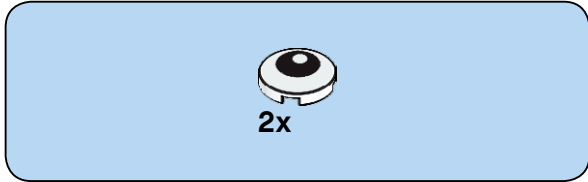

13

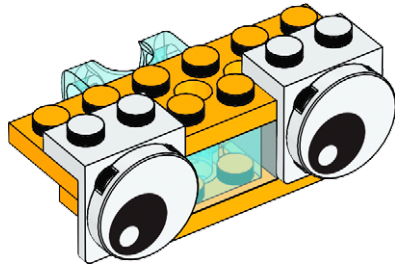

14

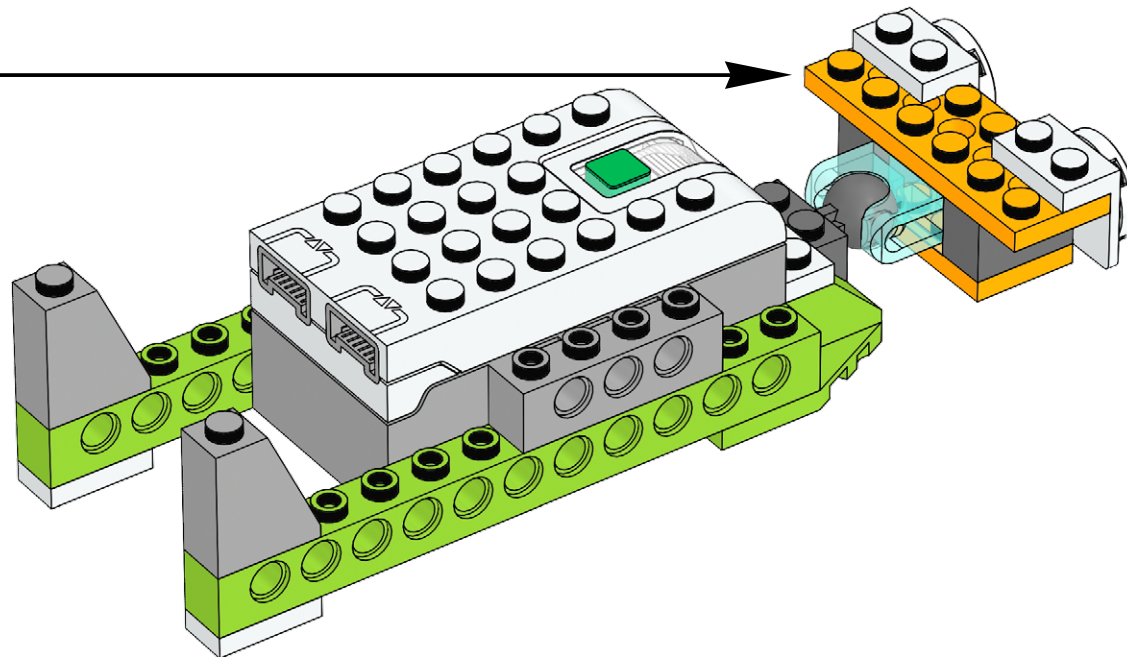

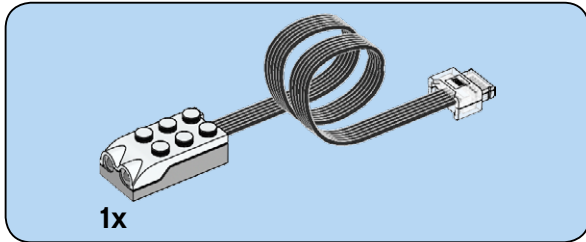

15

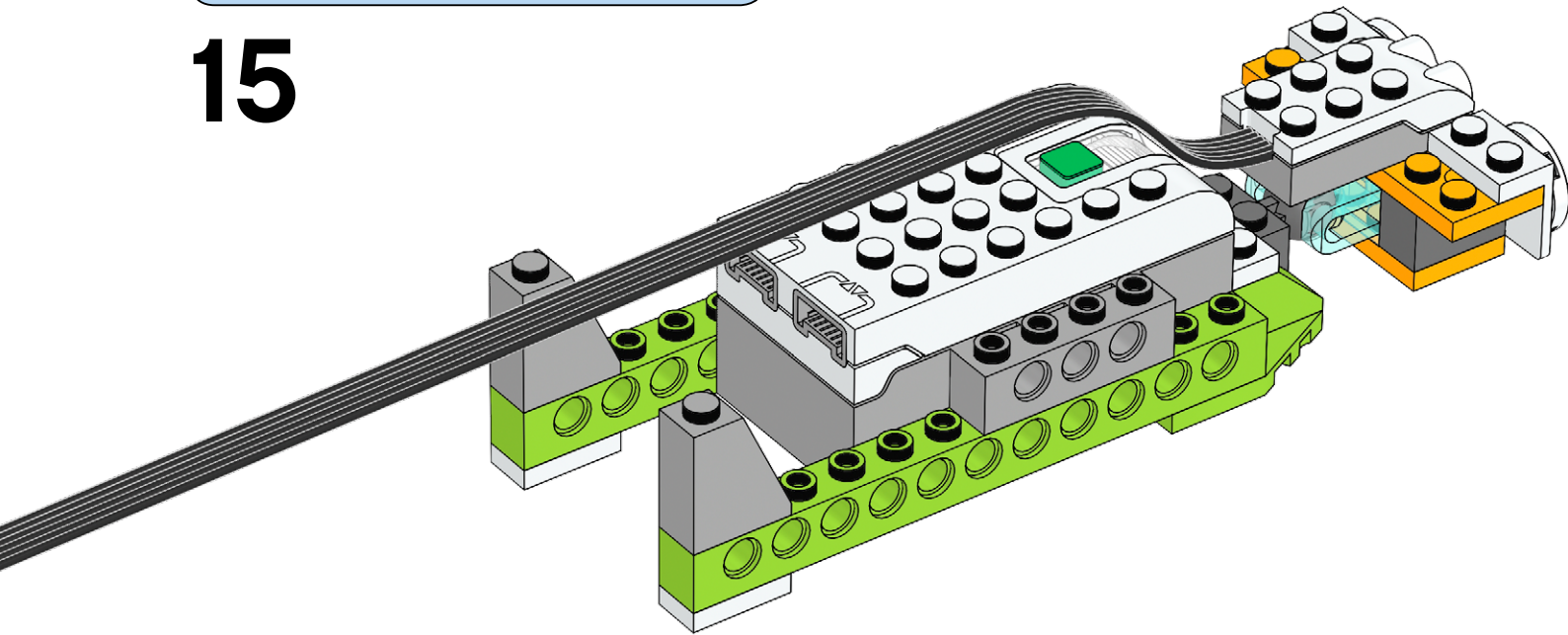

16

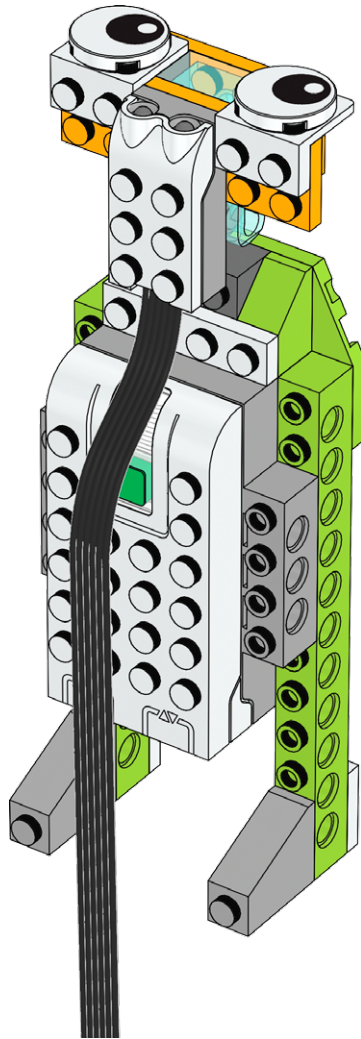
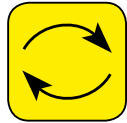

17

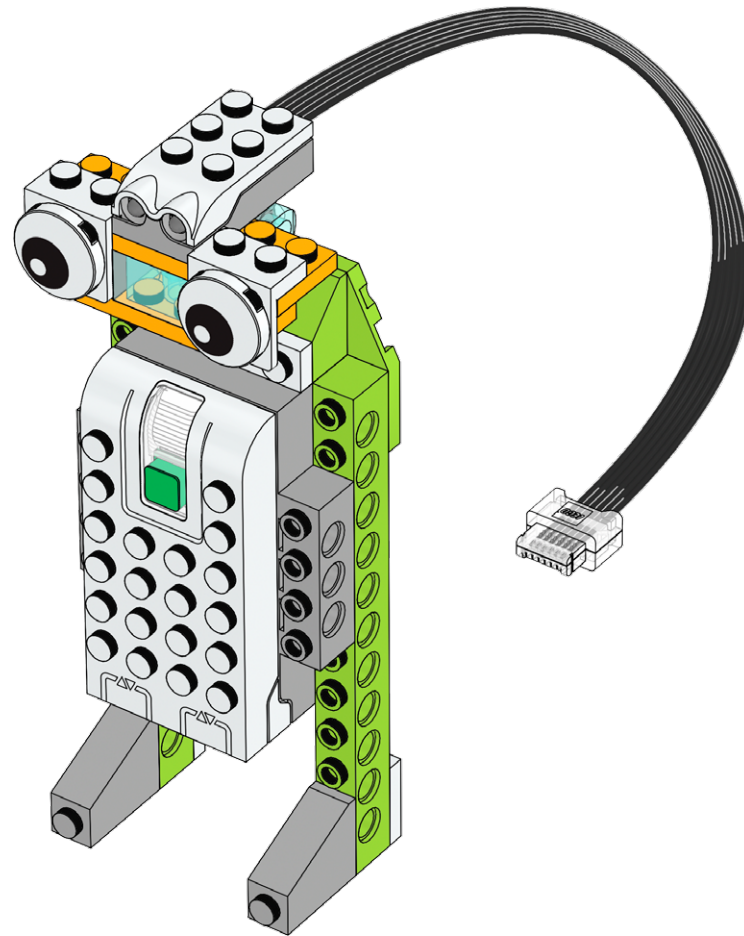

18

