

1

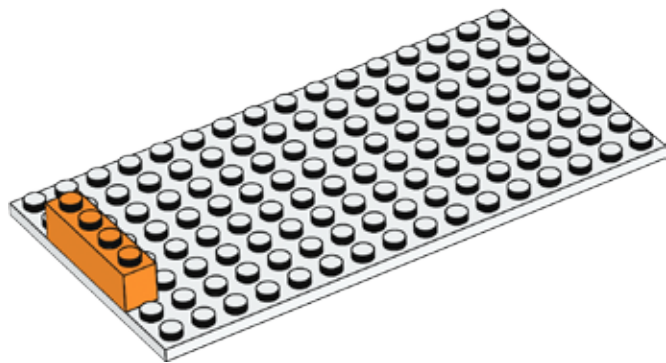



2x

2

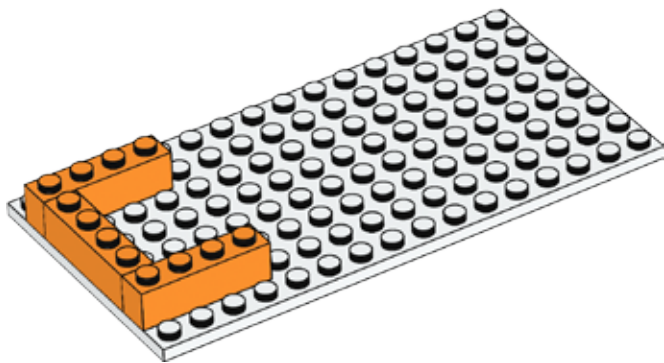

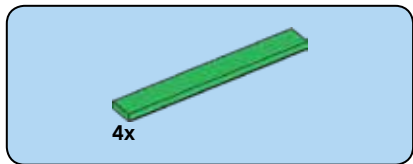

3

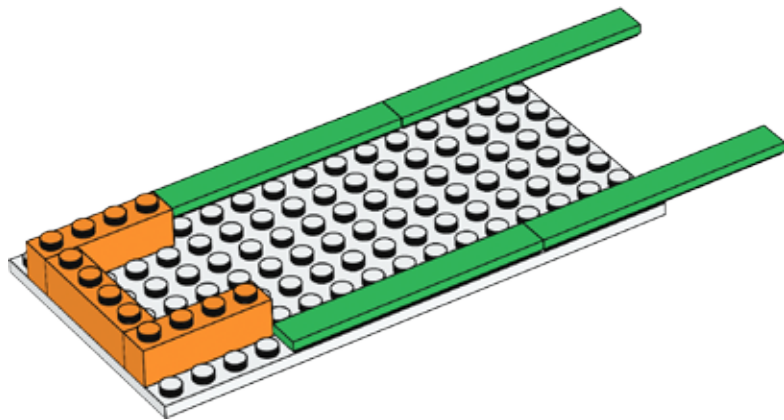



2x



2x

4

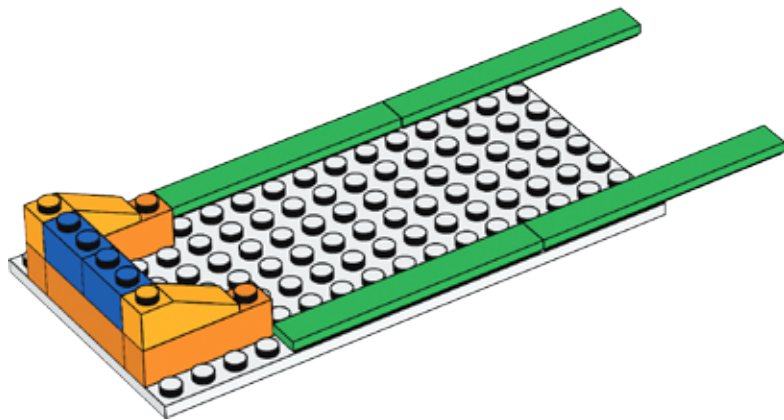

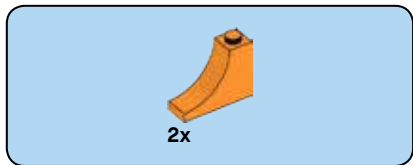

5

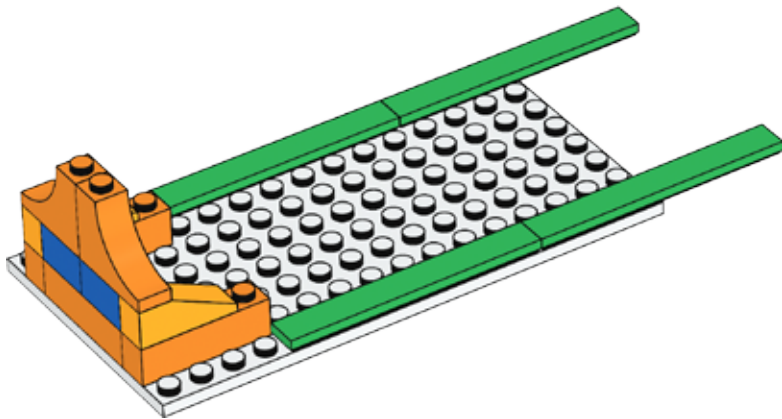

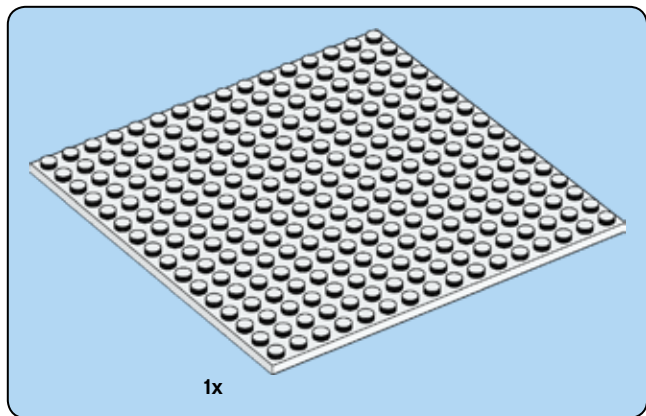

6

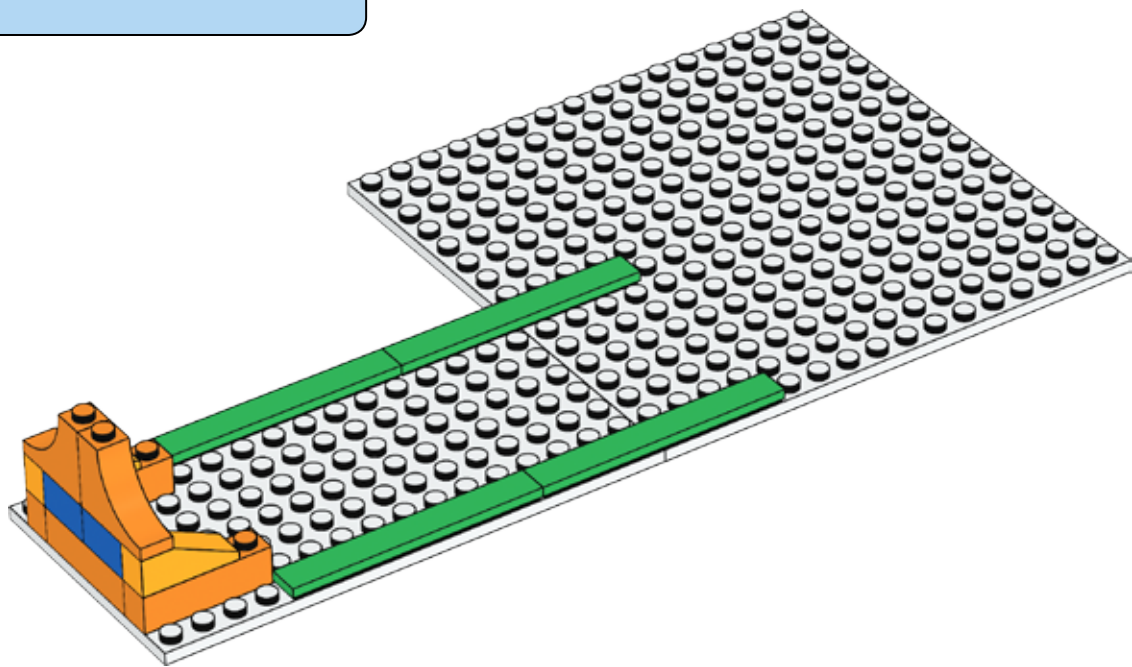

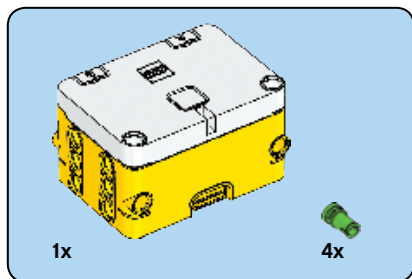

7

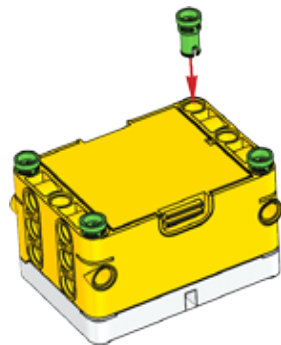

8

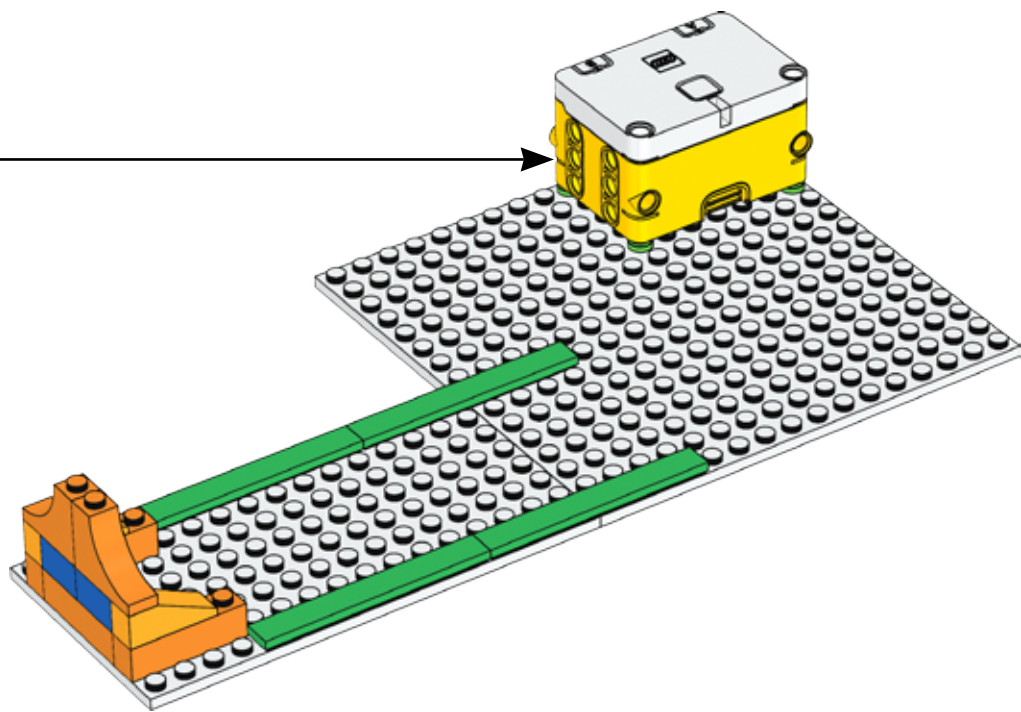



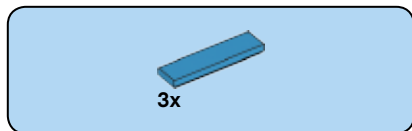

9

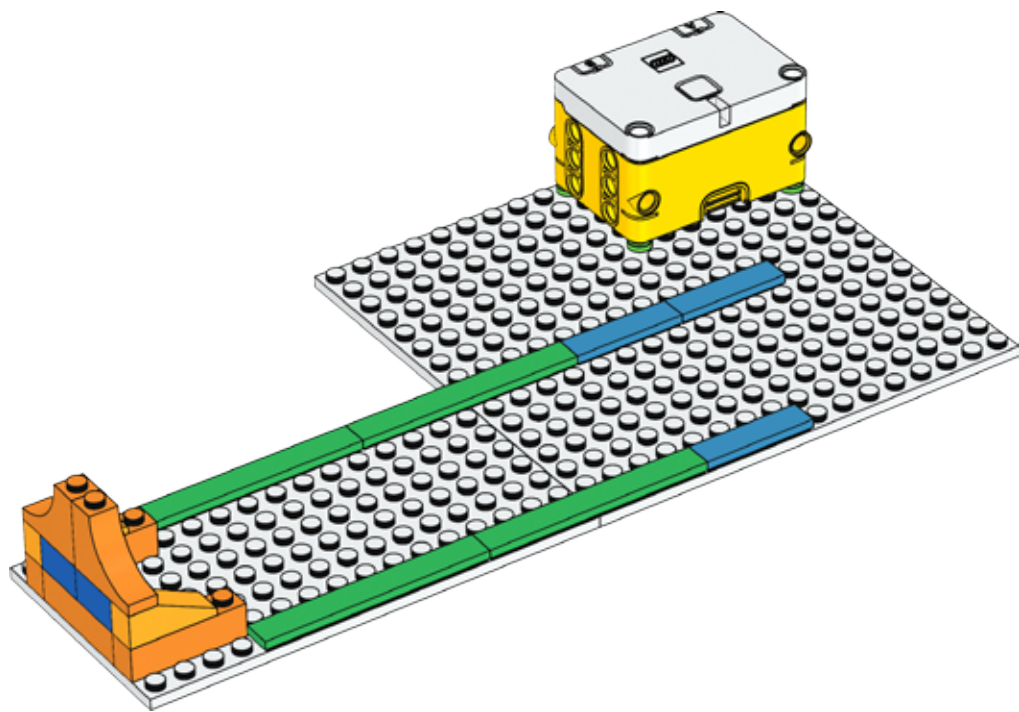

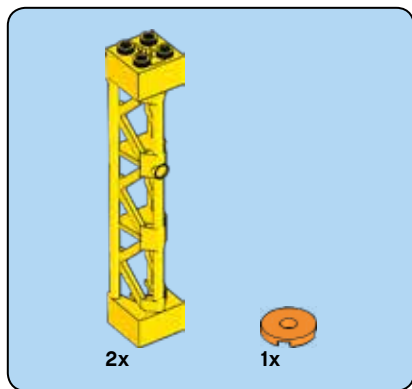

10

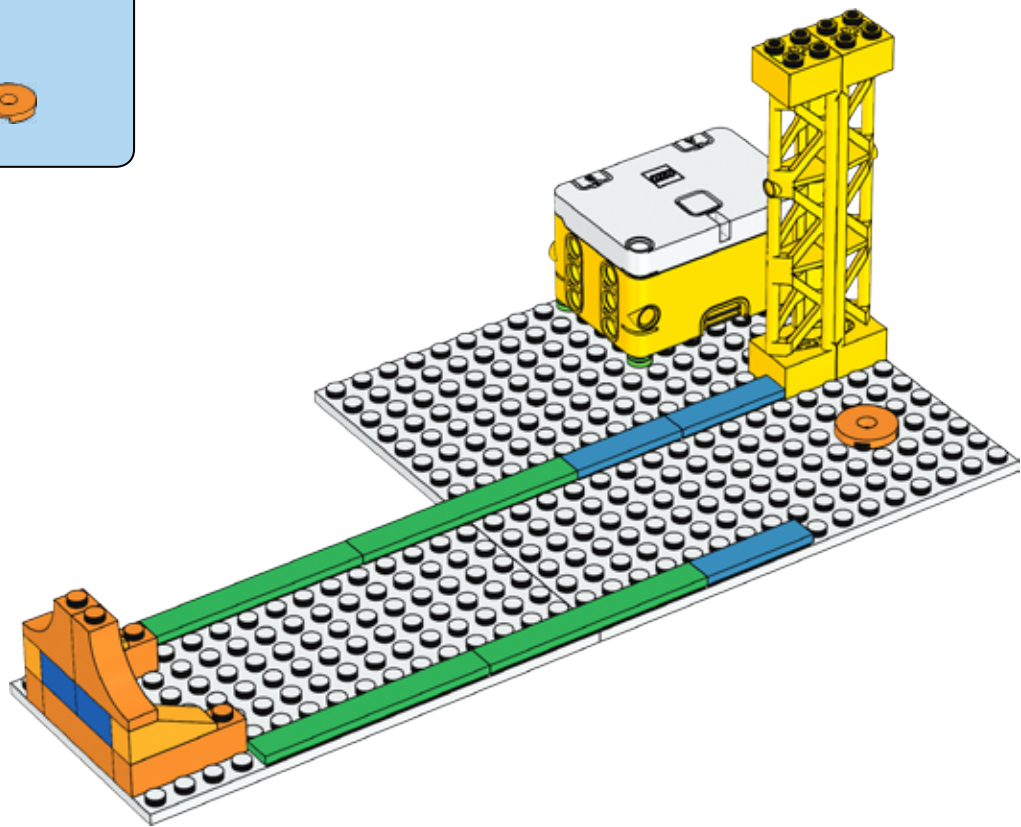

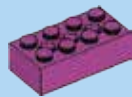

1x

11

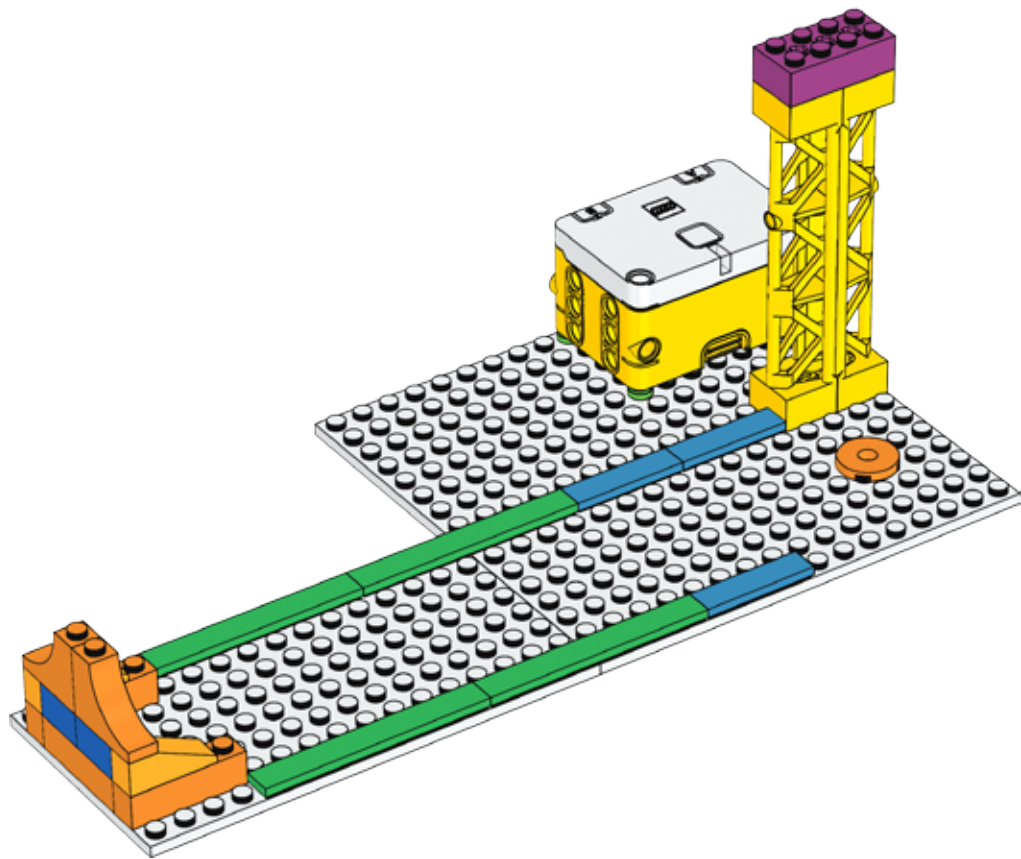



2x

12

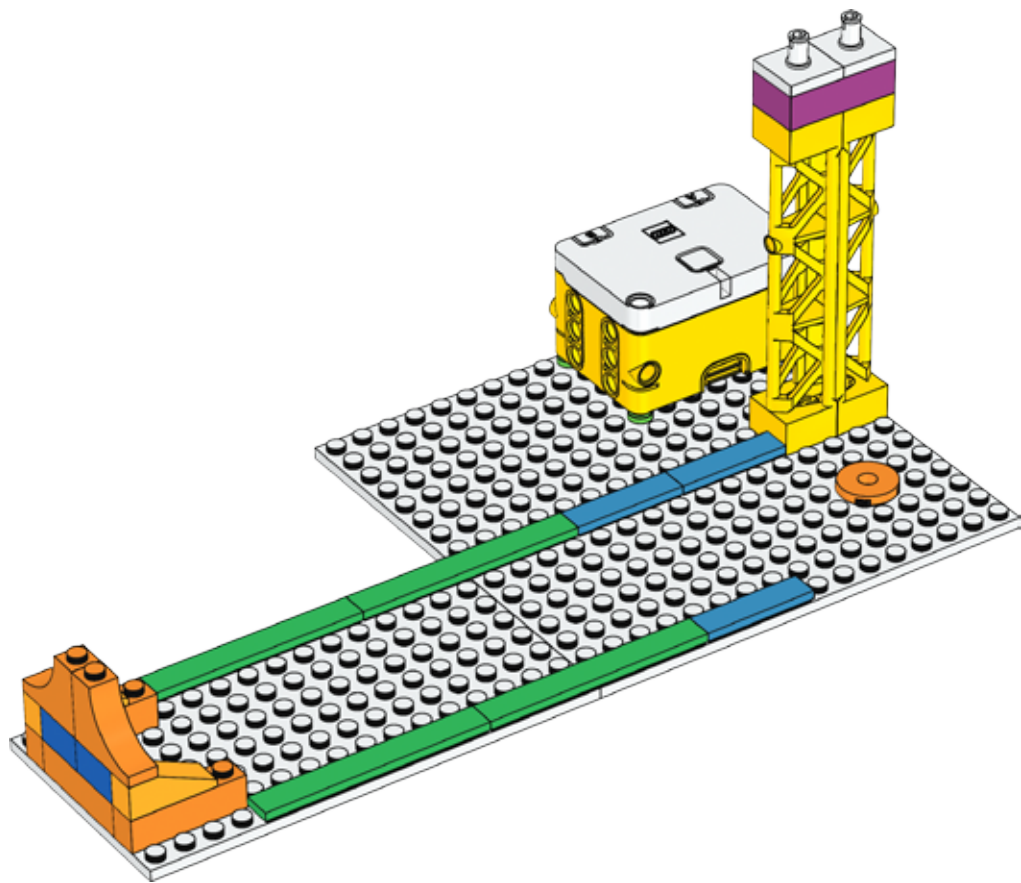

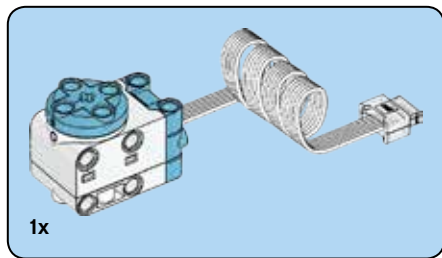

13

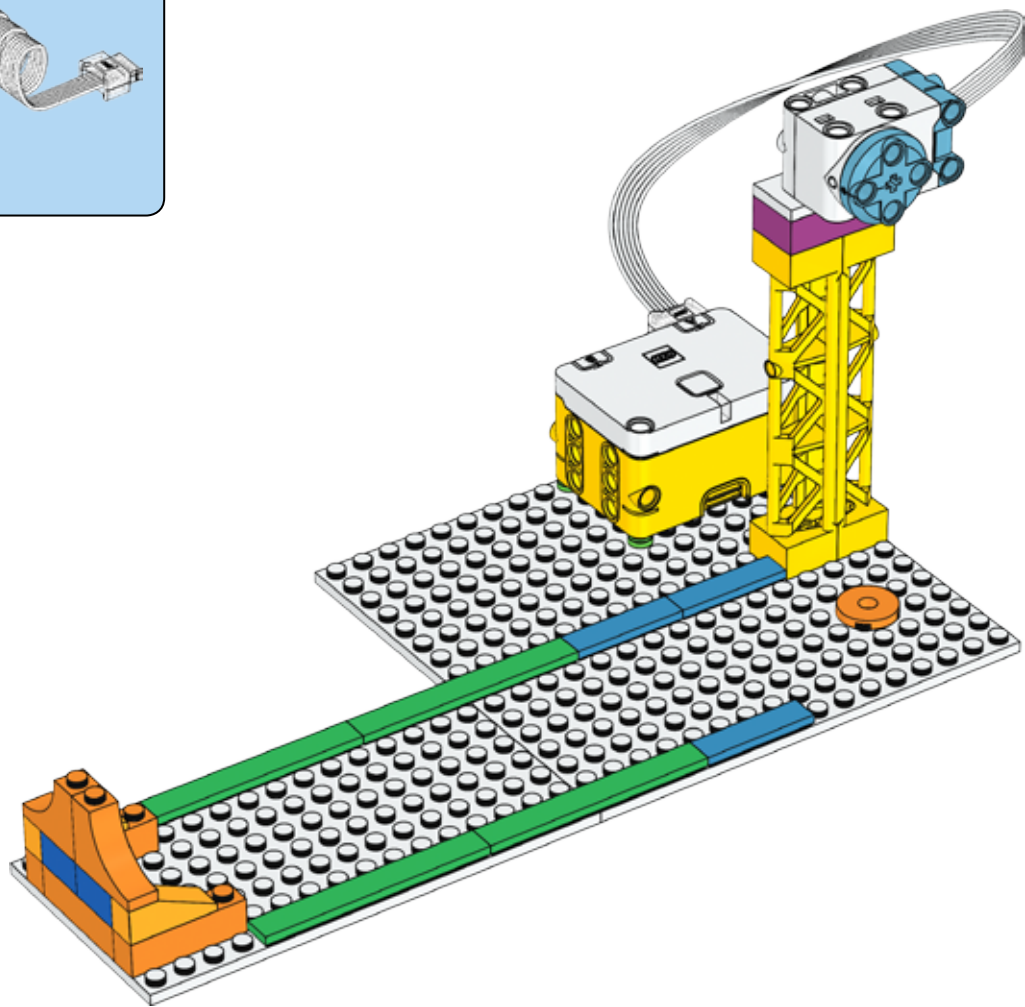



2x

14

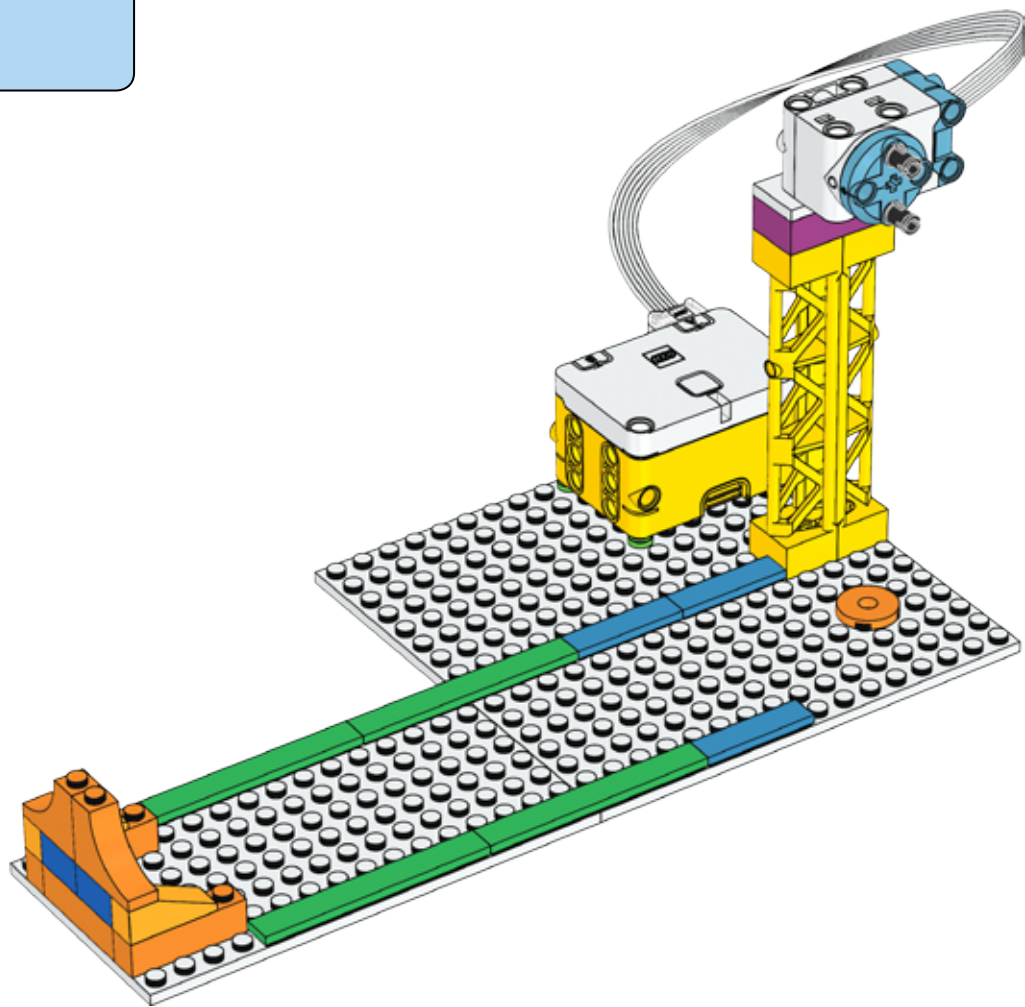



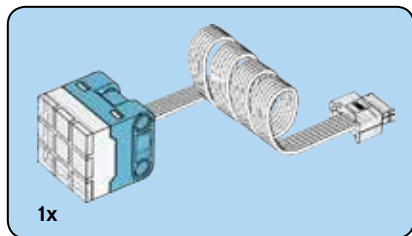

16

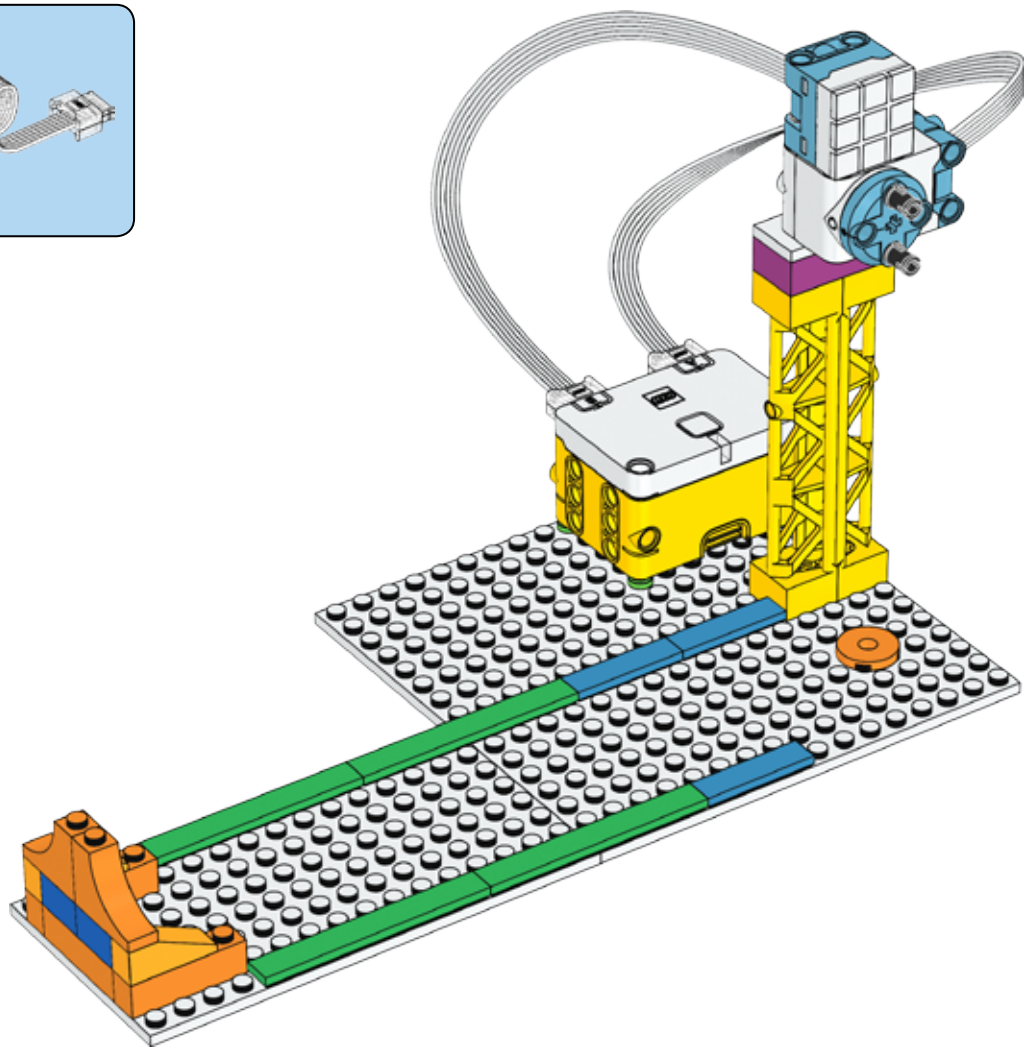



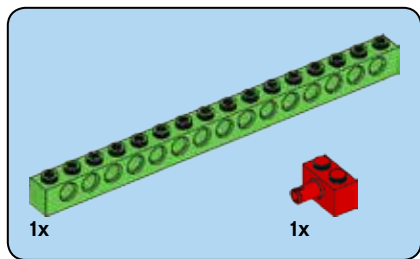

17

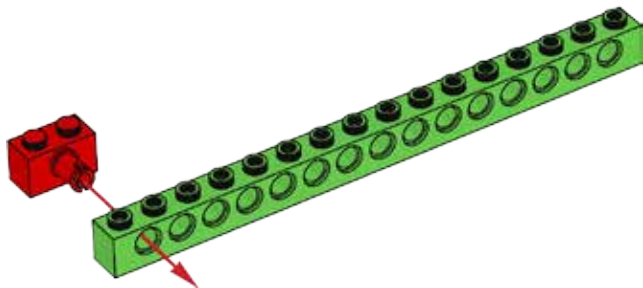



1x

18

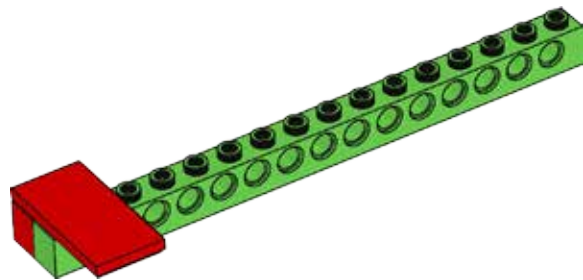

19

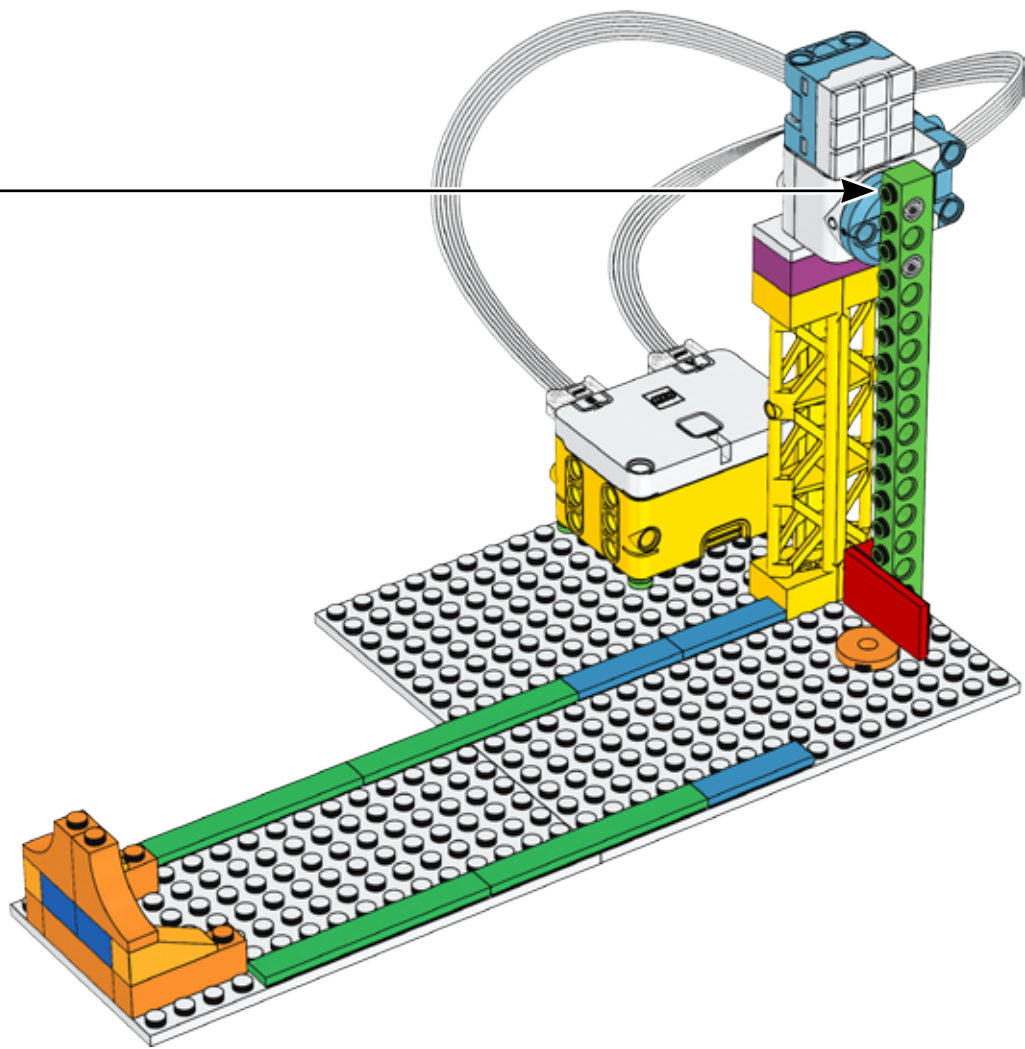



1x

20

