



























- |   |   |   |
|---|---|---|
| <br>1x   | <br>2x   | <br>4x   |
| <br>1x   | <br>2x   | <br>2x   |
| <br>2x   | <br>2x   | <br>2x   |
| <br>1x   | <br>1x   | <br>2x   |
| <br>4x   | <br>2x   | <br>1x   |
| <br>4x   | <br>3x  | <br>3x   |
| <br>3x | <br>2x | <br>1x |
| <br>1x | <br>4x | <br>2x |
| <br>3x |   | <br>4x |



1

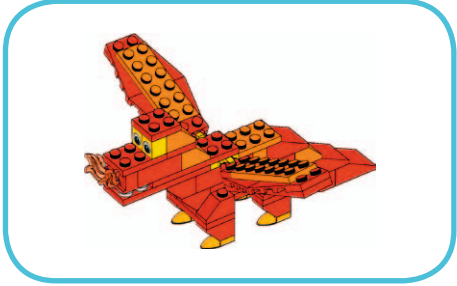
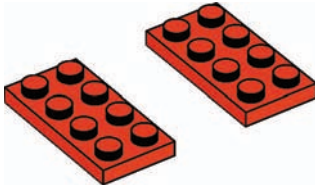

2

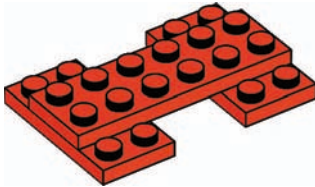

3

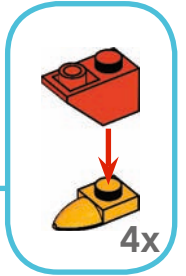
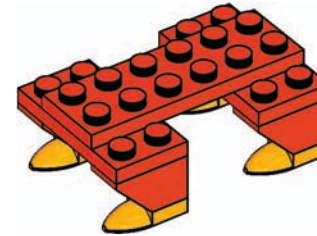

4

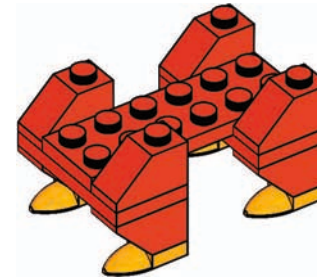



5

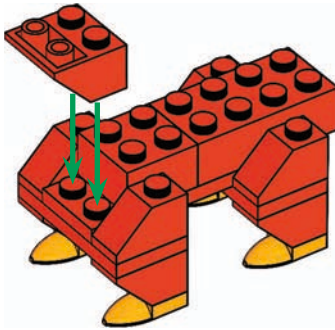

6

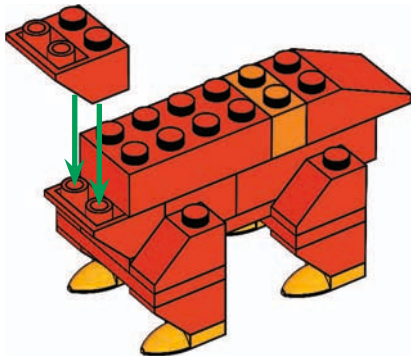

7

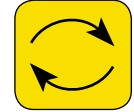
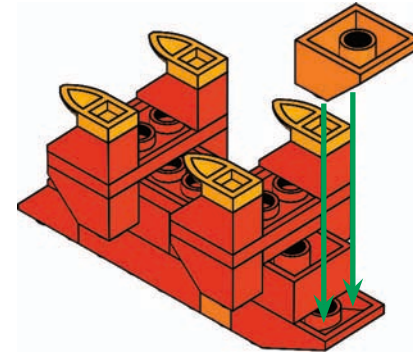

8

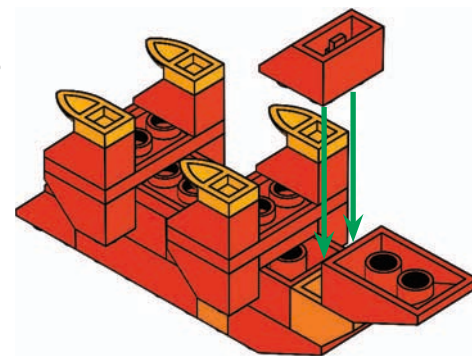



9

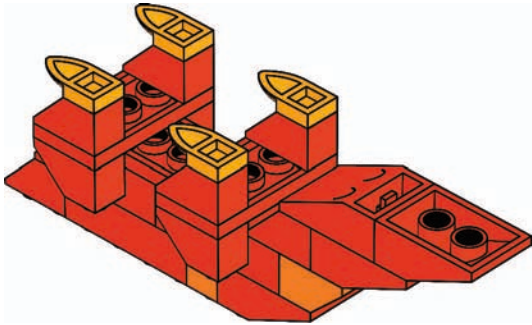

10

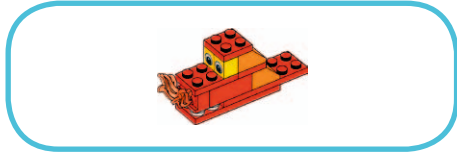
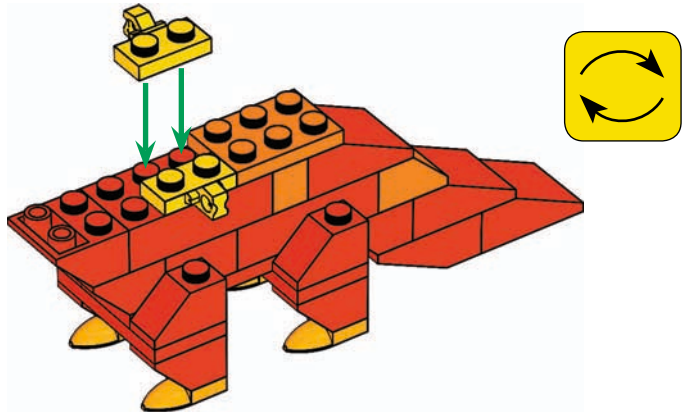

11

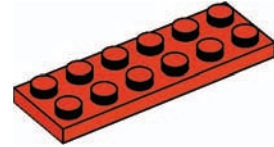

12

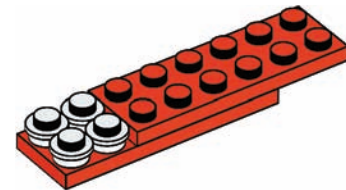



13

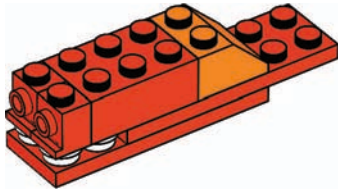

14

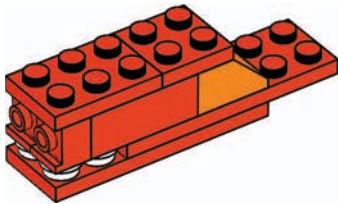

15

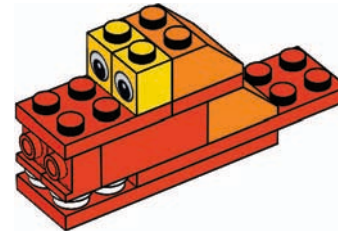

16

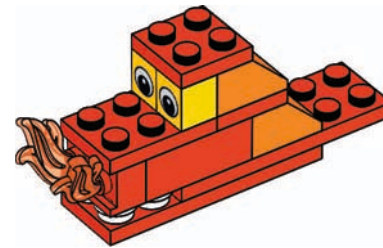



17

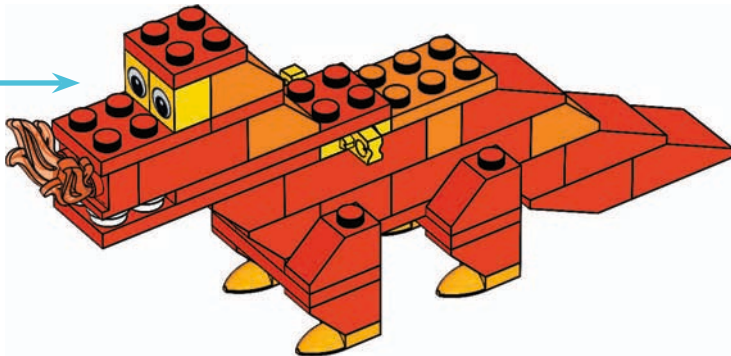

18

