

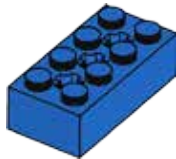

1x

1

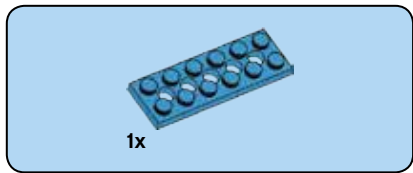



2



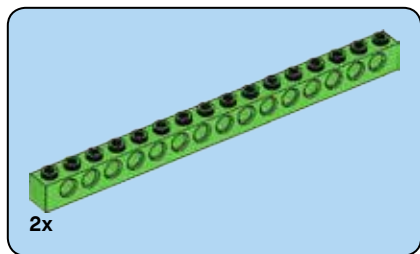

3

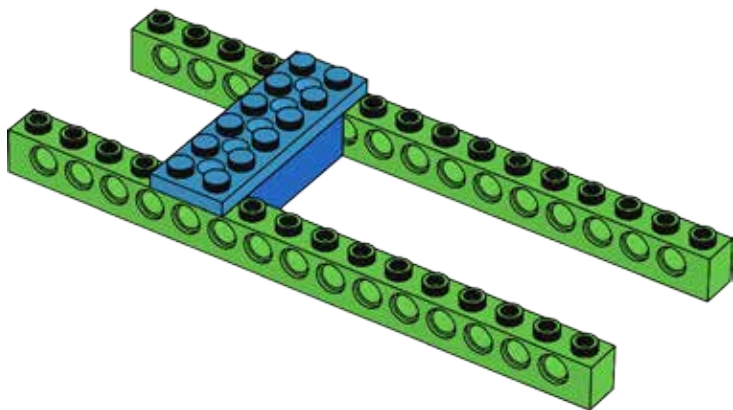

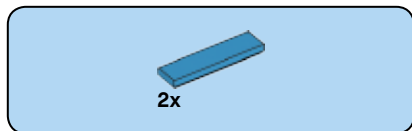

4

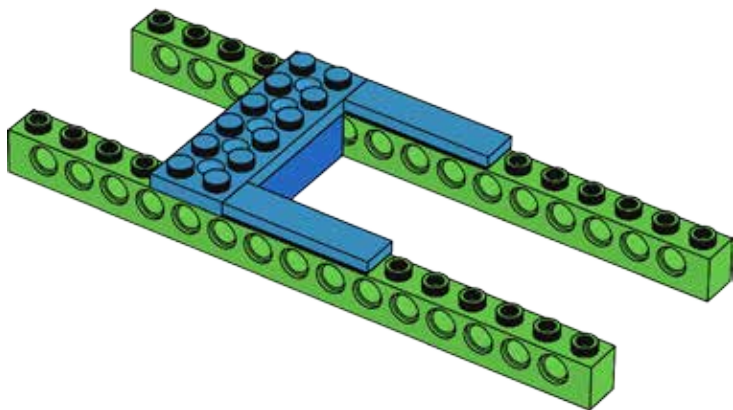

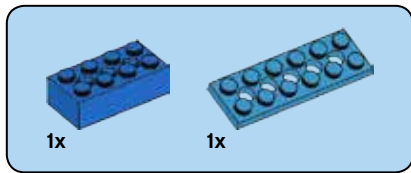

5

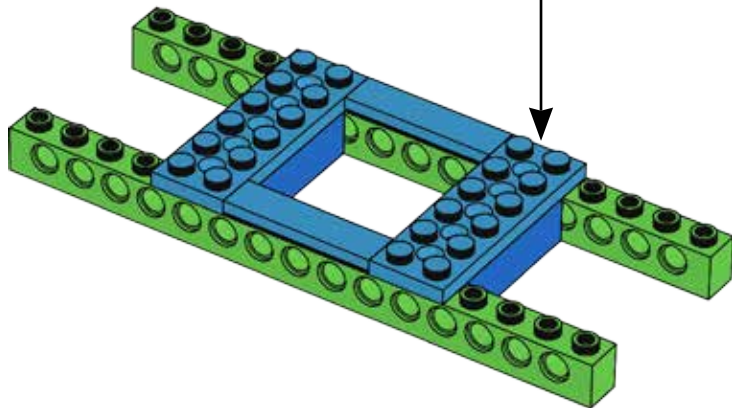
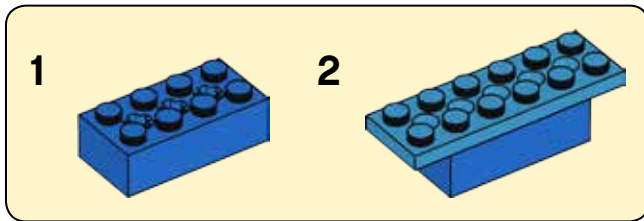

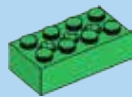

2x

6

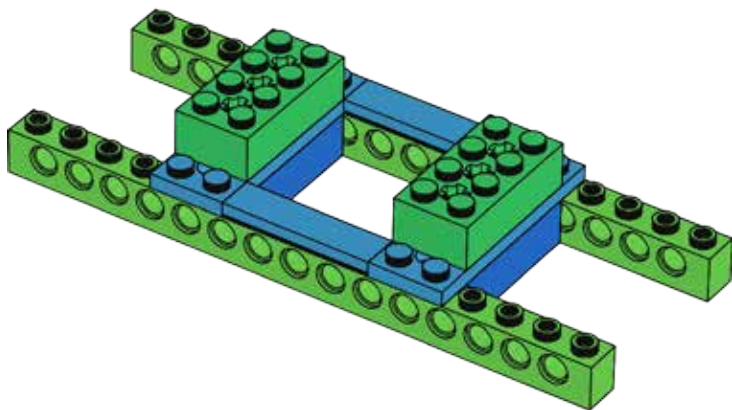



7

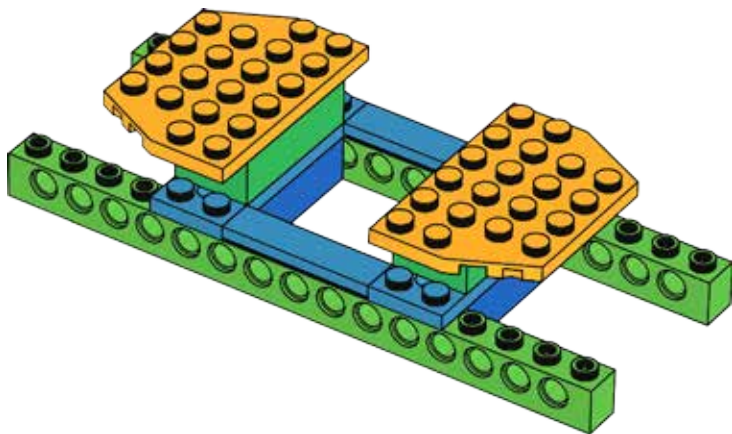

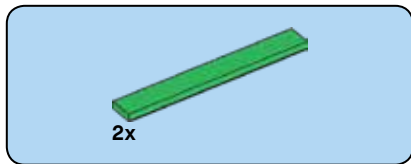

8

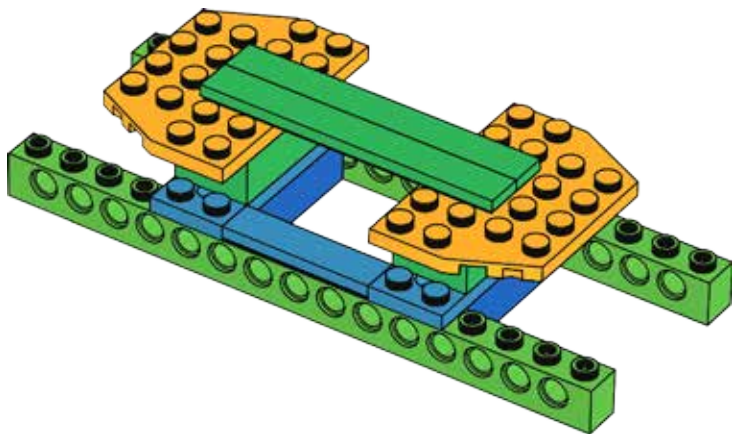

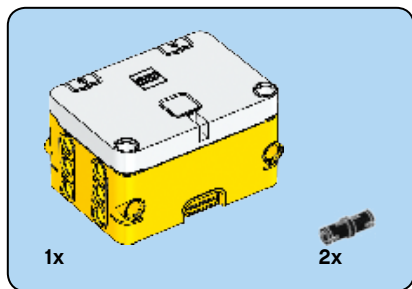

9

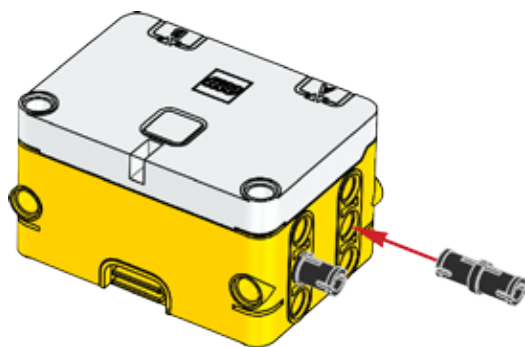

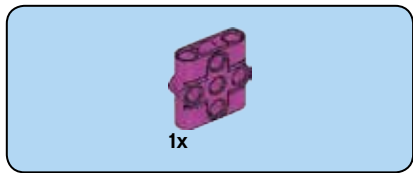

10

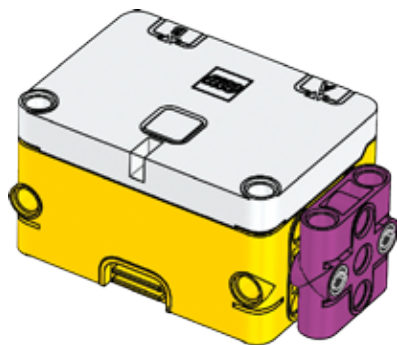



2x

11

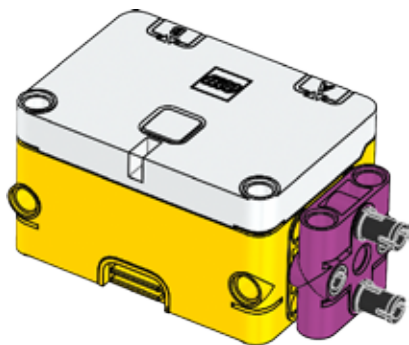



1x

12

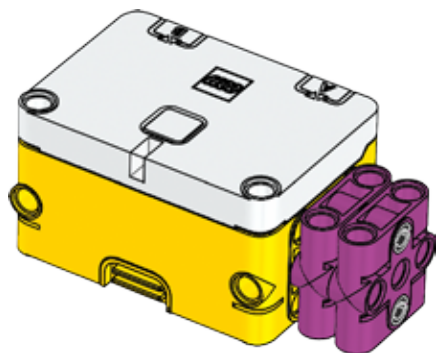



2x

13

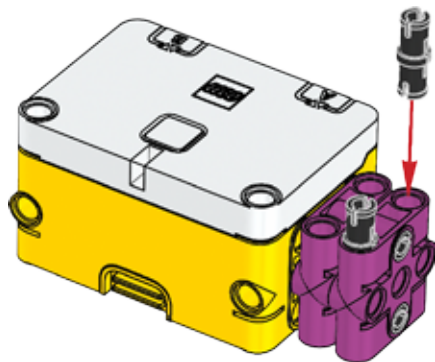



6x

14

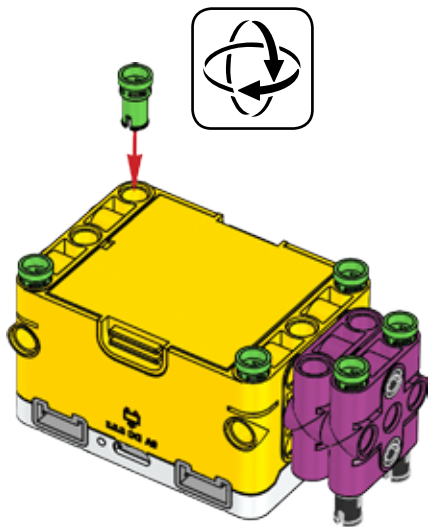

15

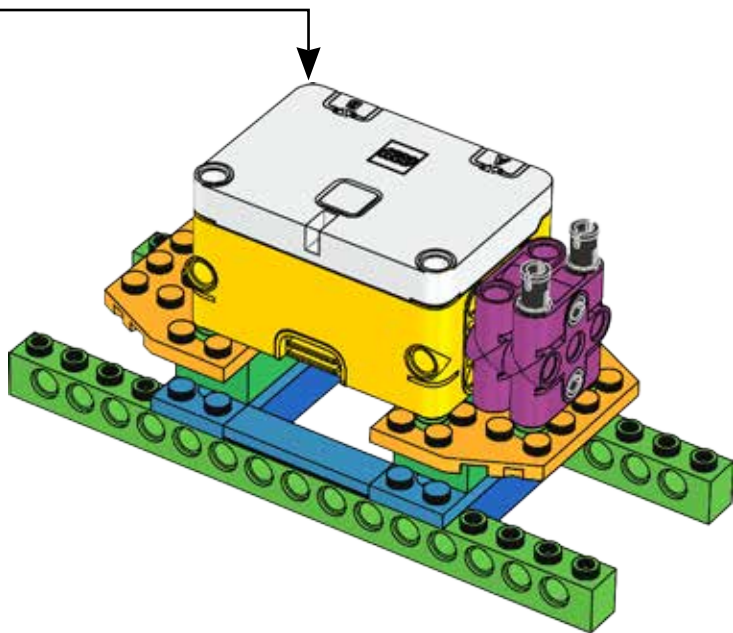

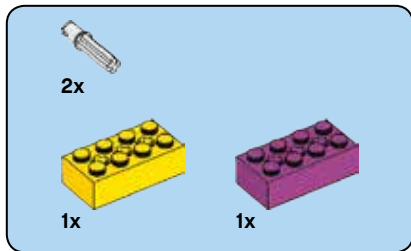

16

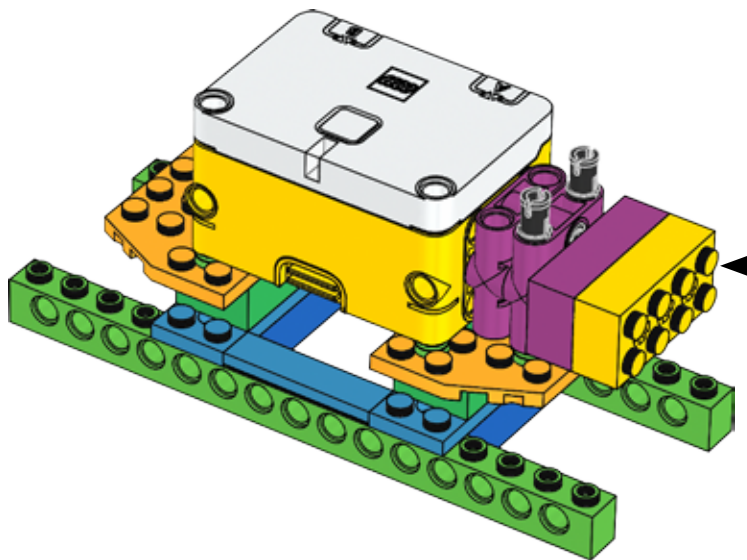
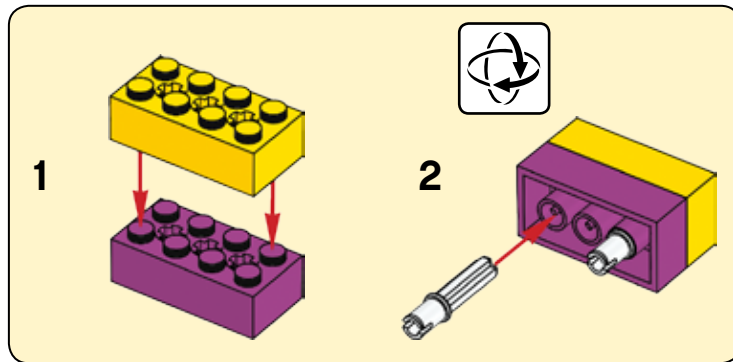

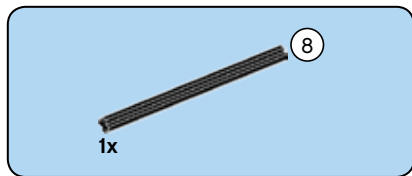

17

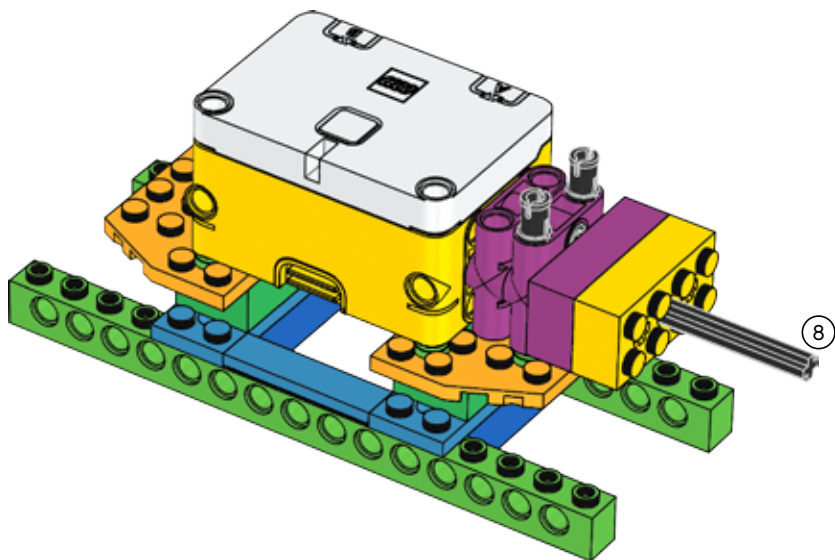

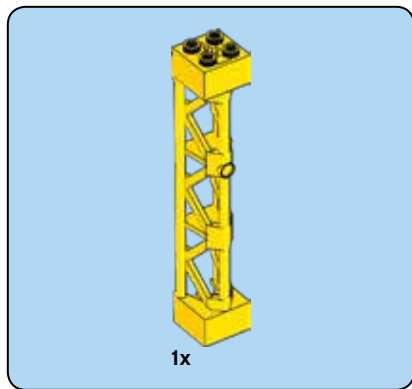

18

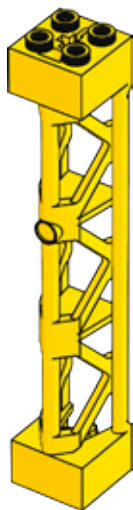



2x

19





1x

20

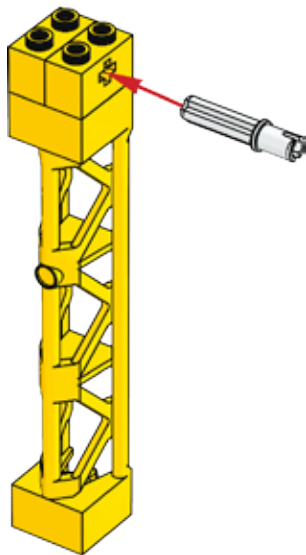

21

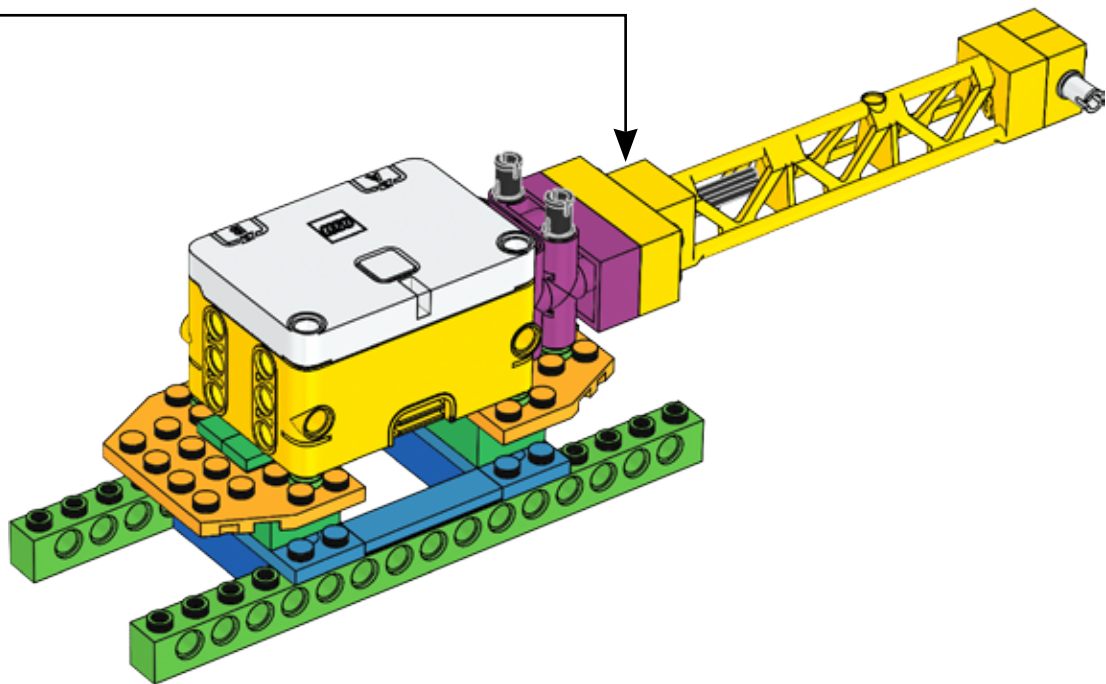

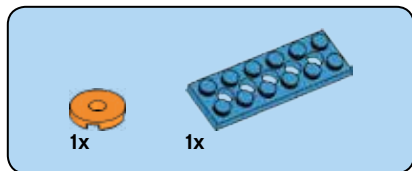

22

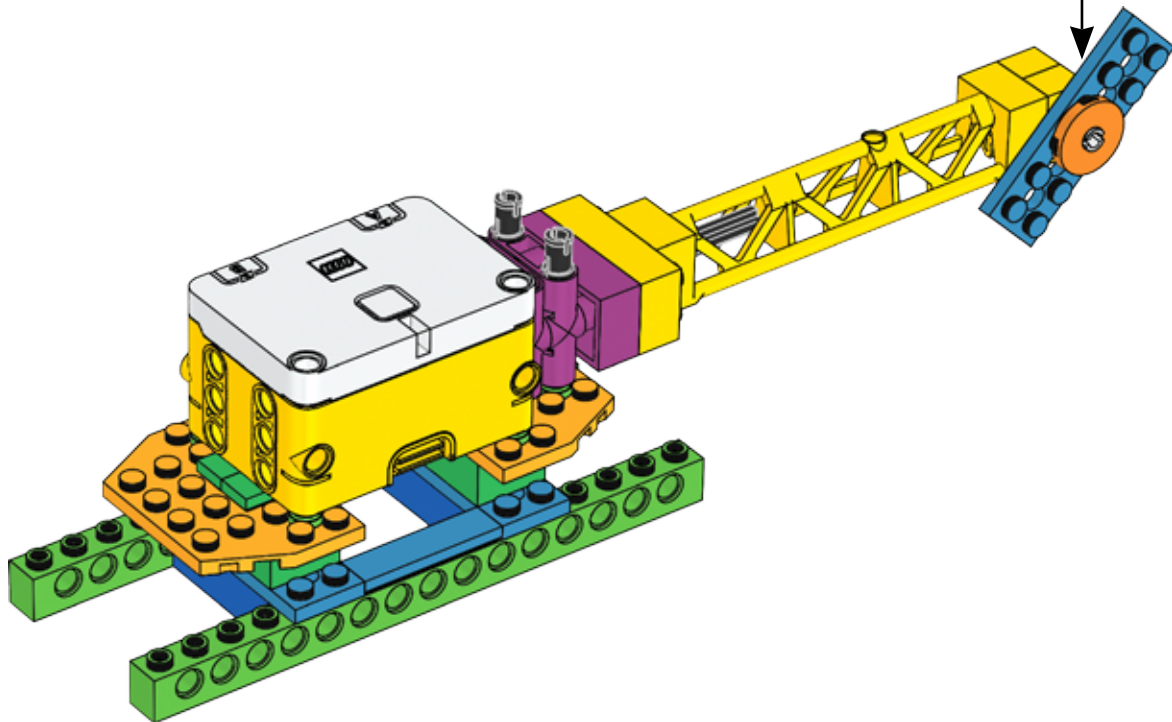
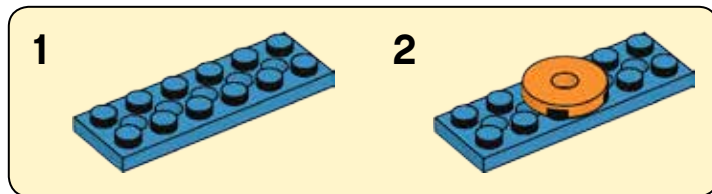

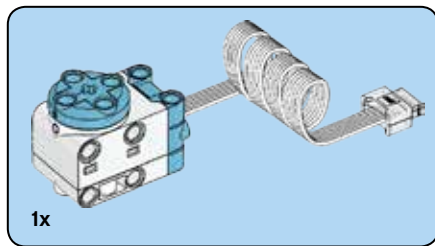

23

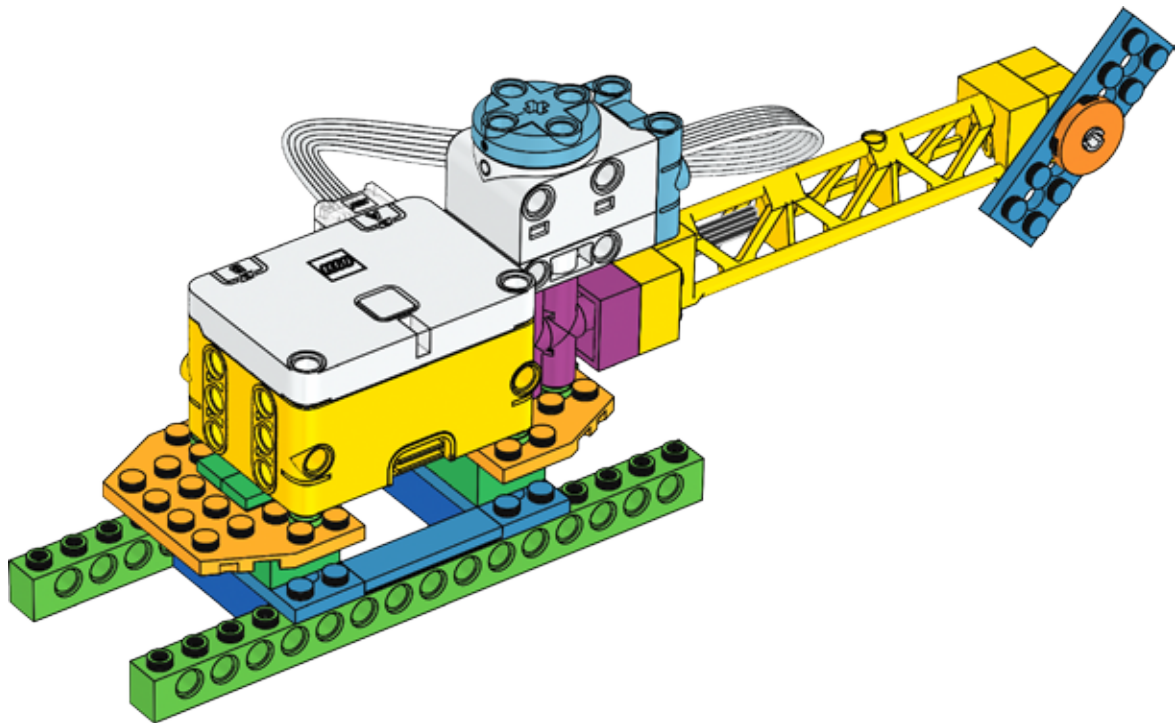



2x

24

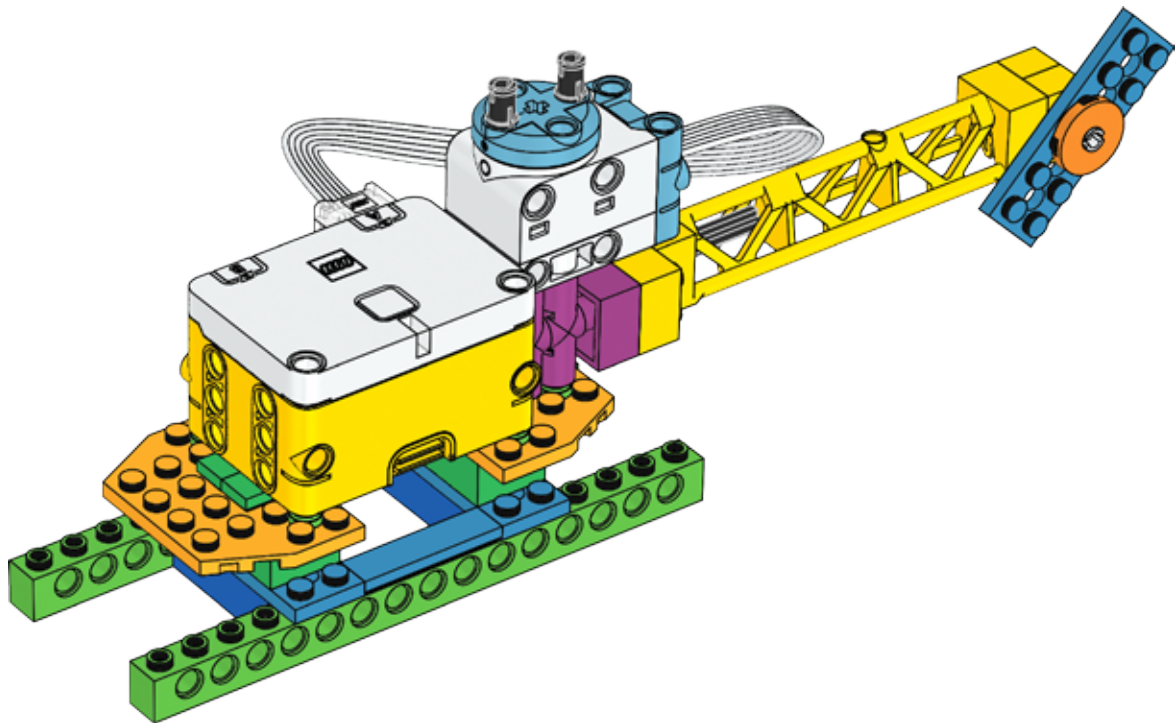

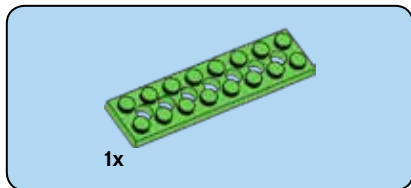

25

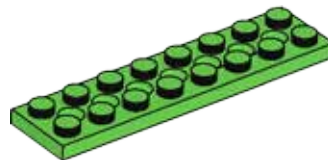



1x

26

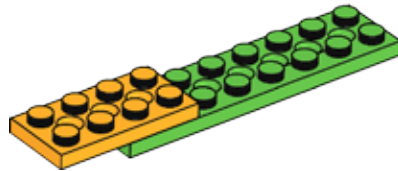

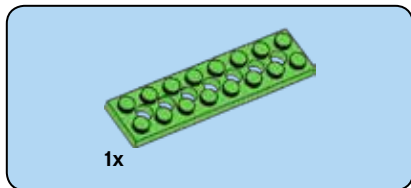

27

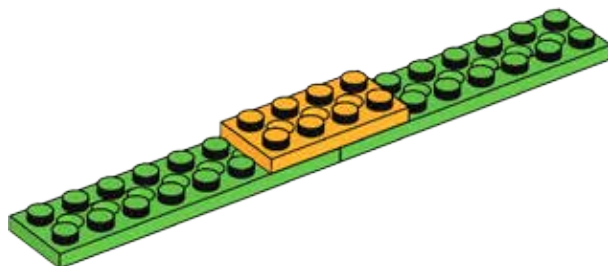

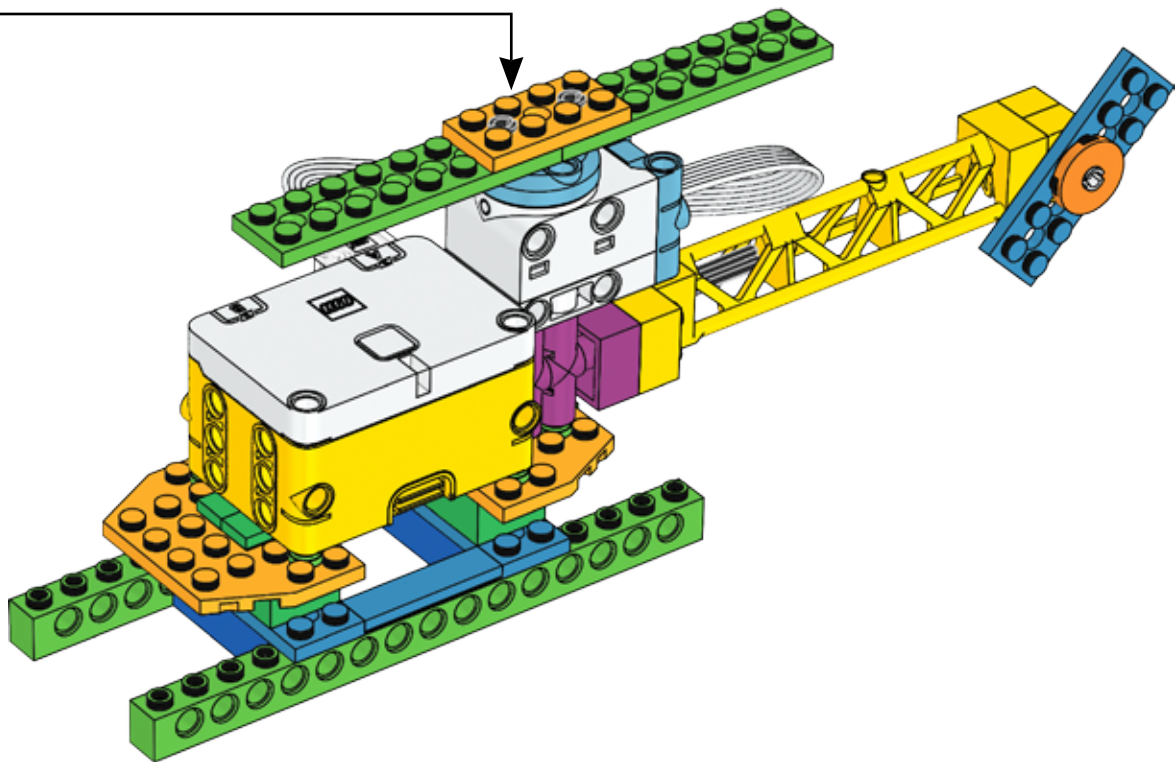

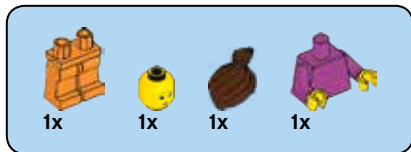

29

