

1 x

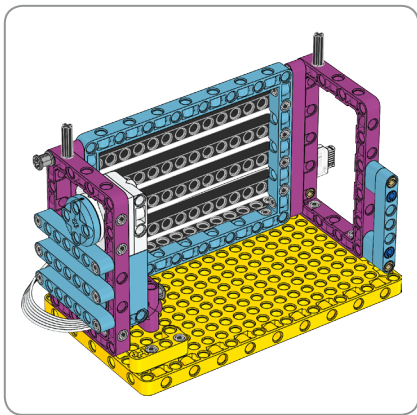

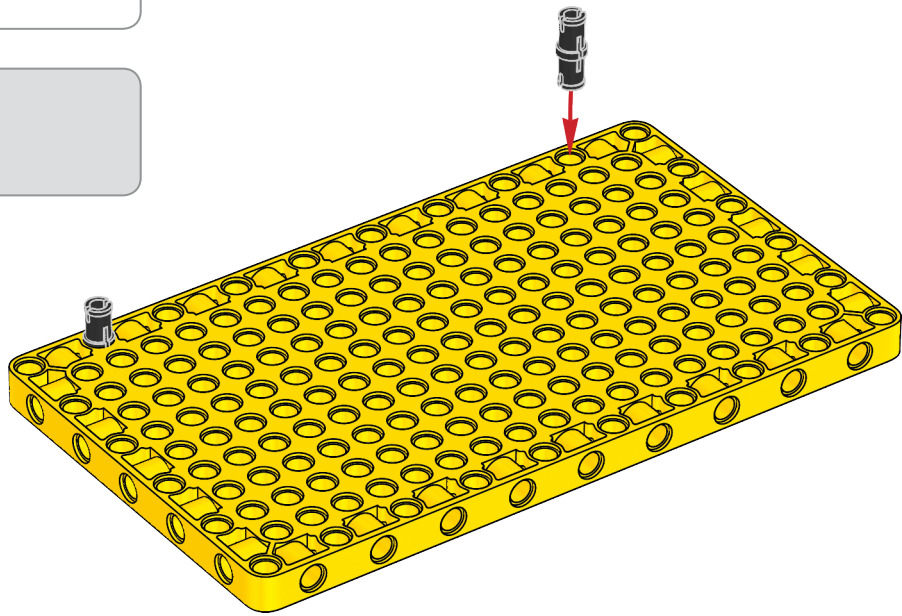

1



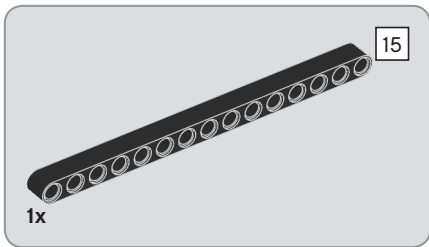

2

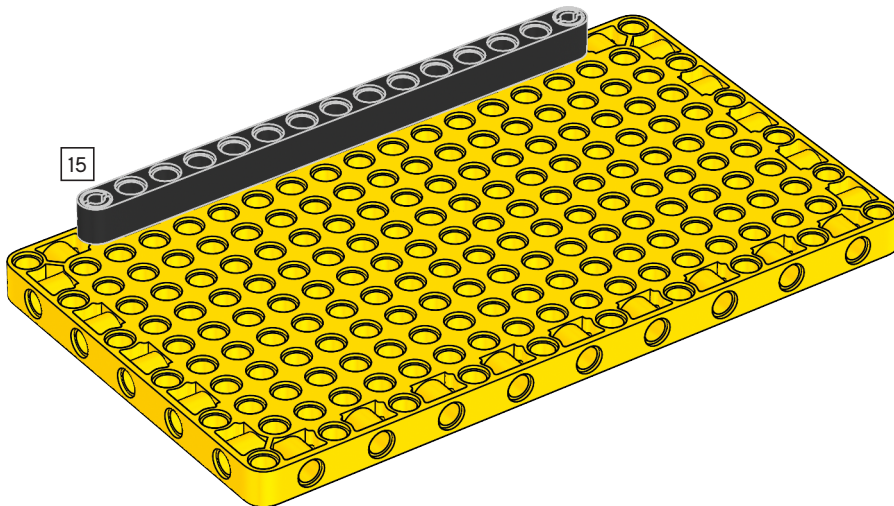



4x

3

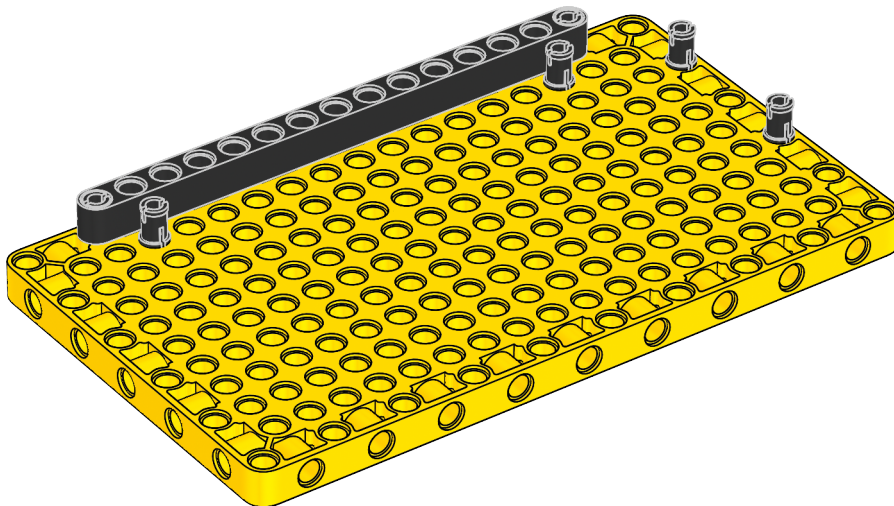

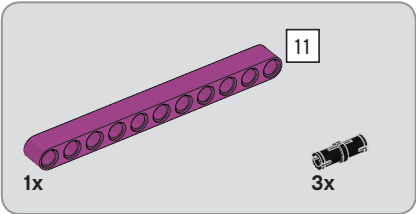
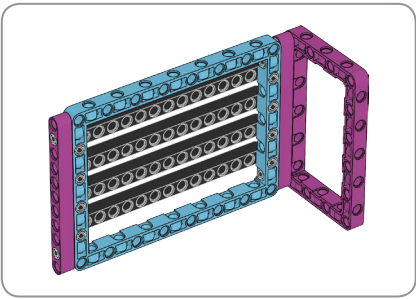

4

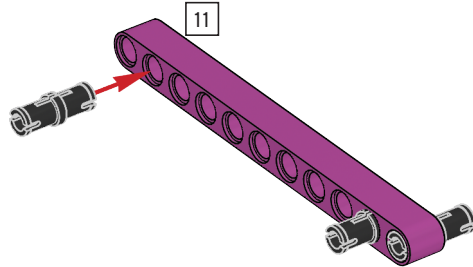

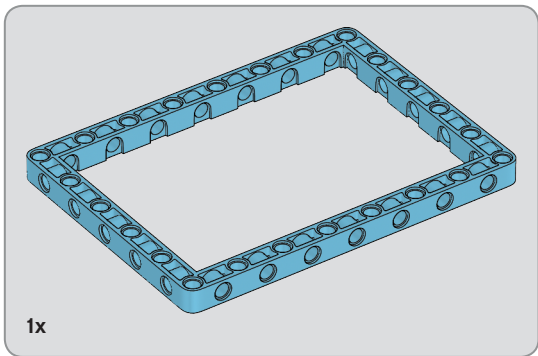

5

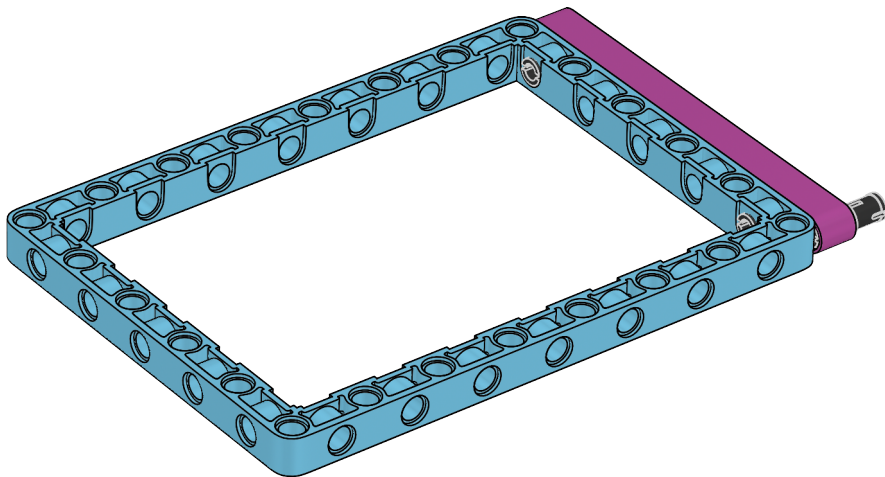



8x

6

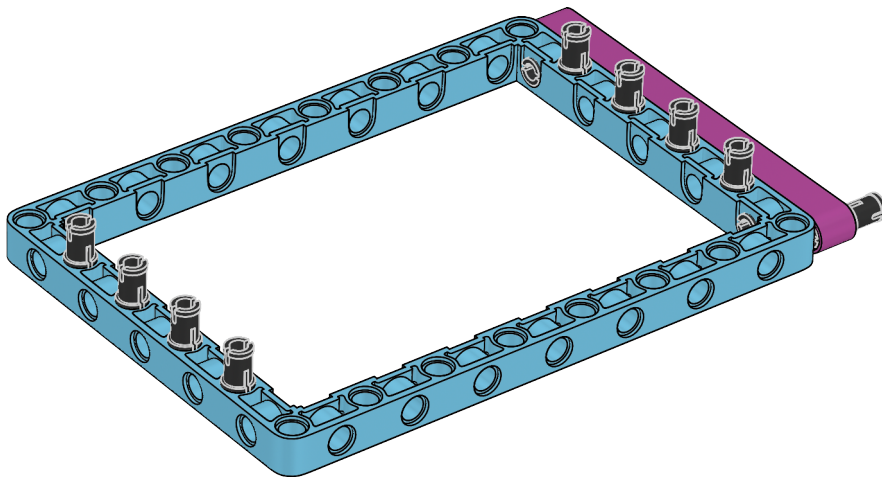



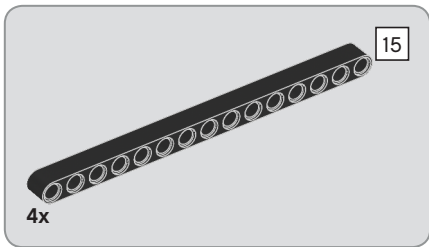

7

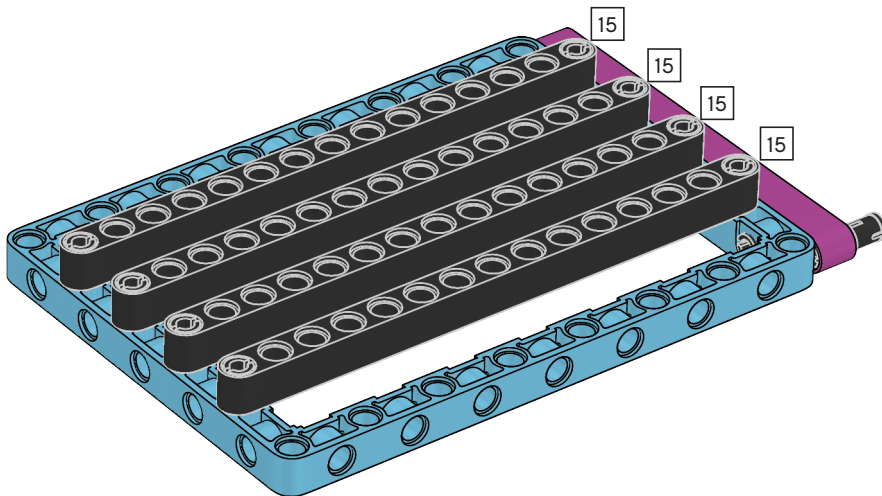



2x

8

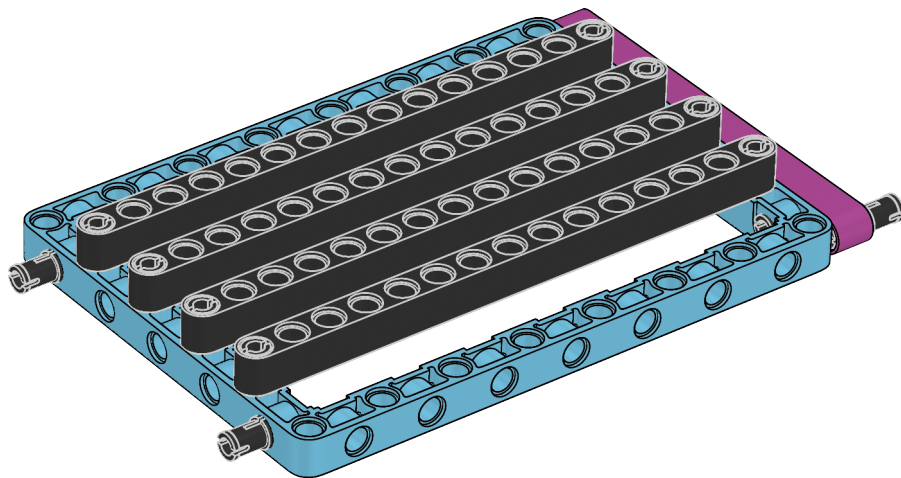

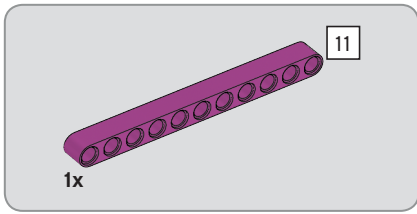

9

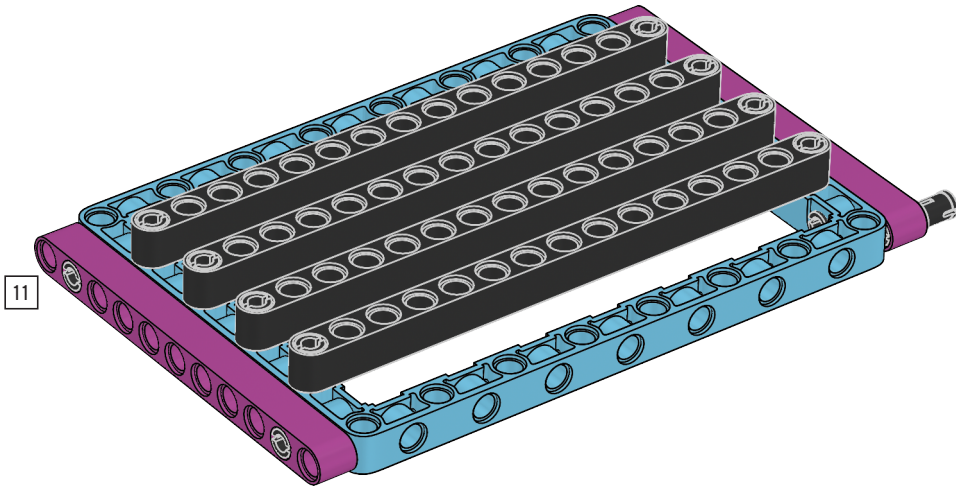

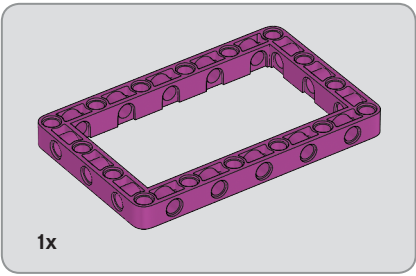

10

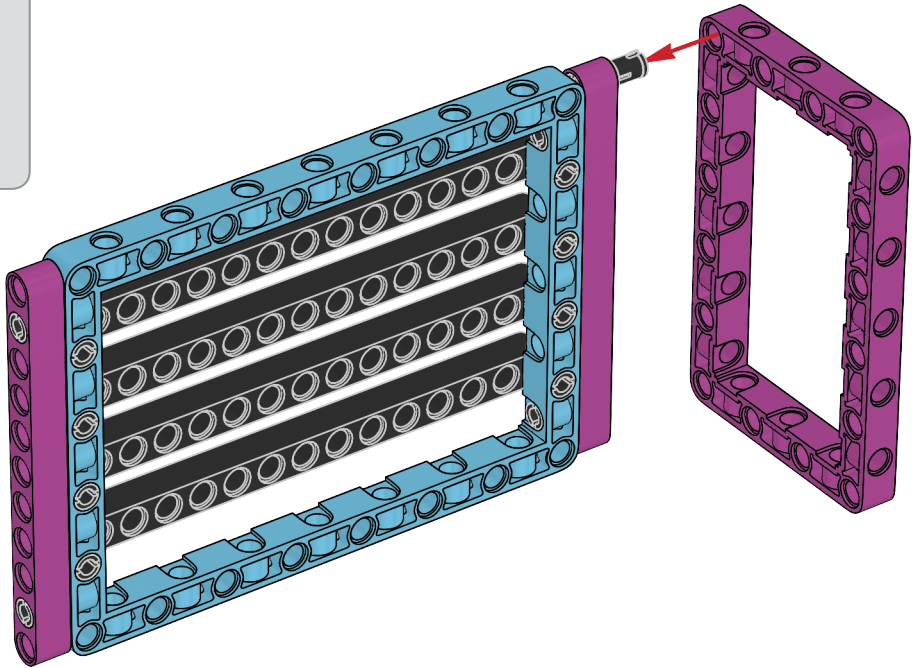

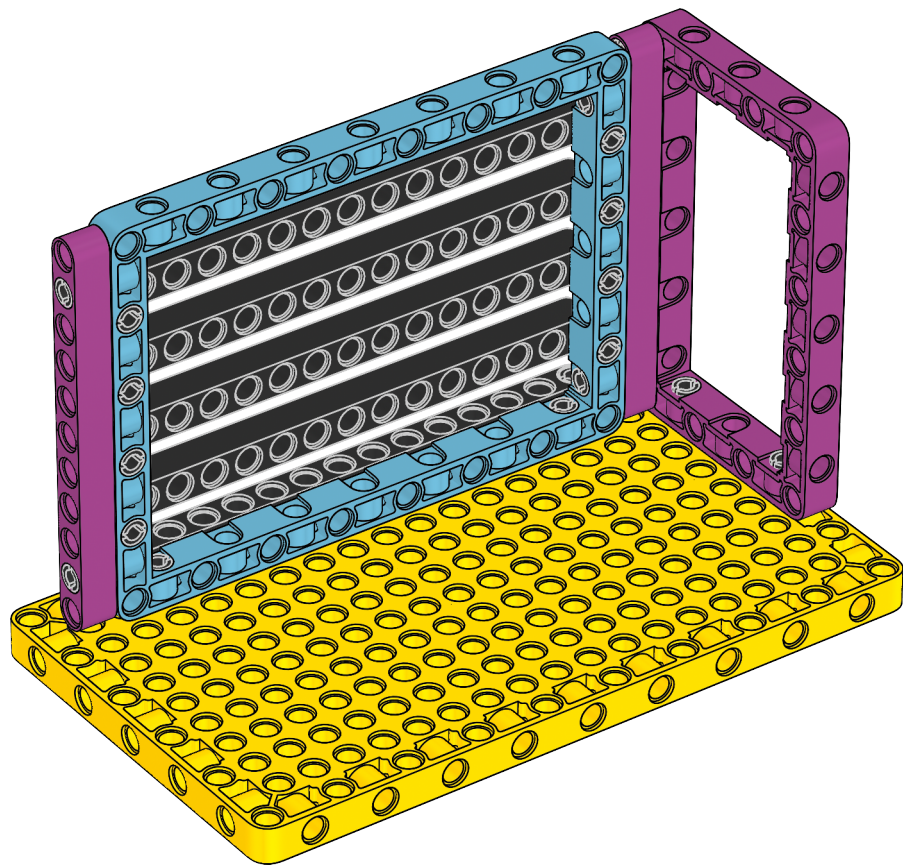

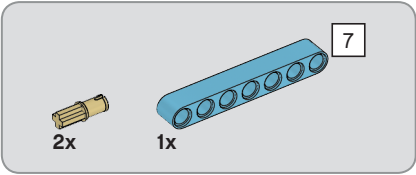
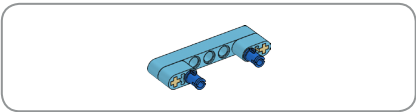

12

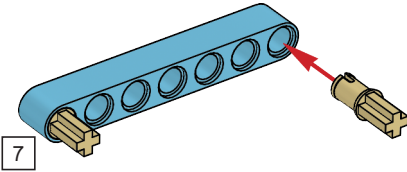



2x

13

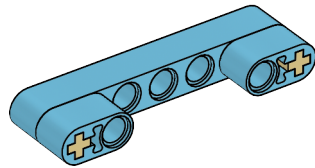



2x

14

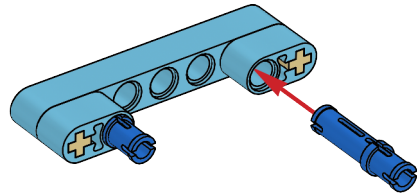



15

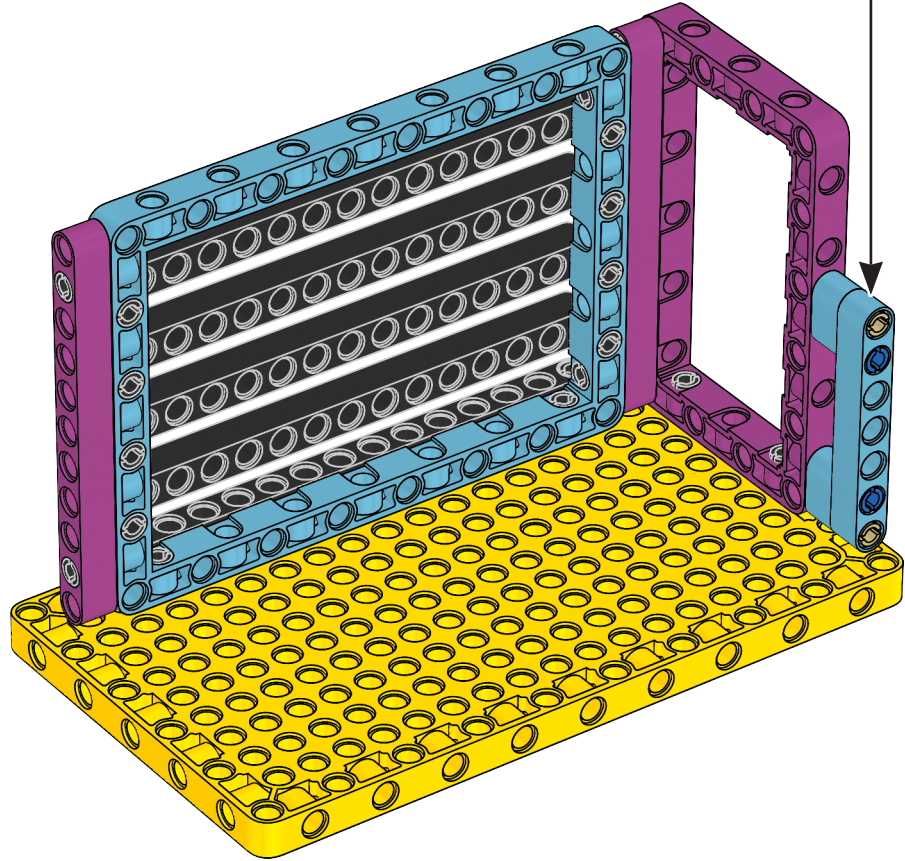



6x

16

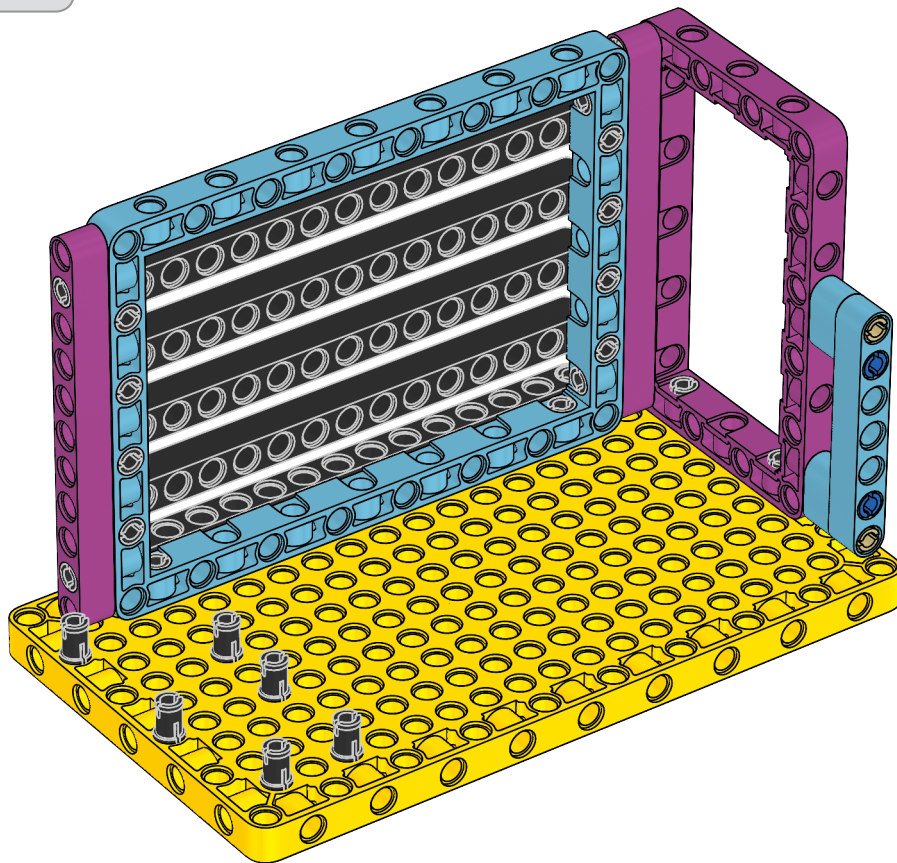

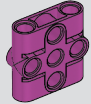

1x

17

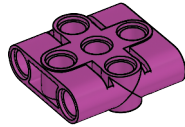



18

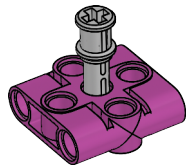

19

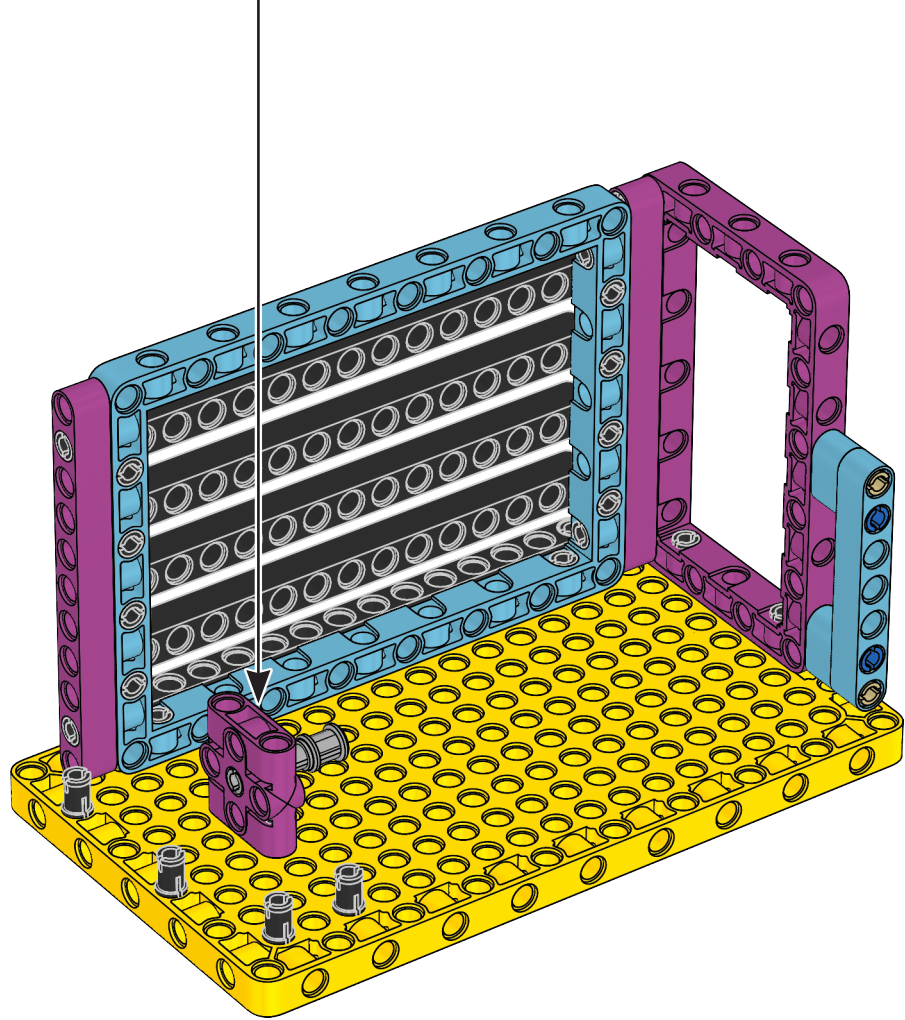

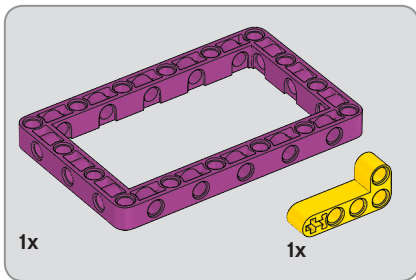

20

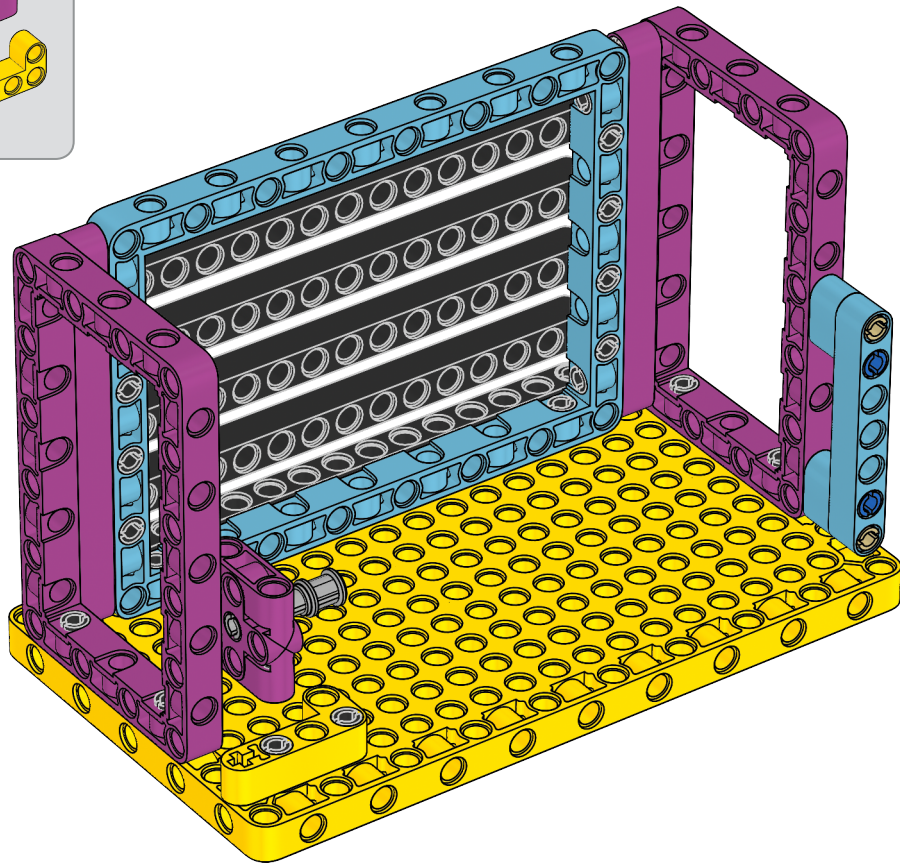



1x

21

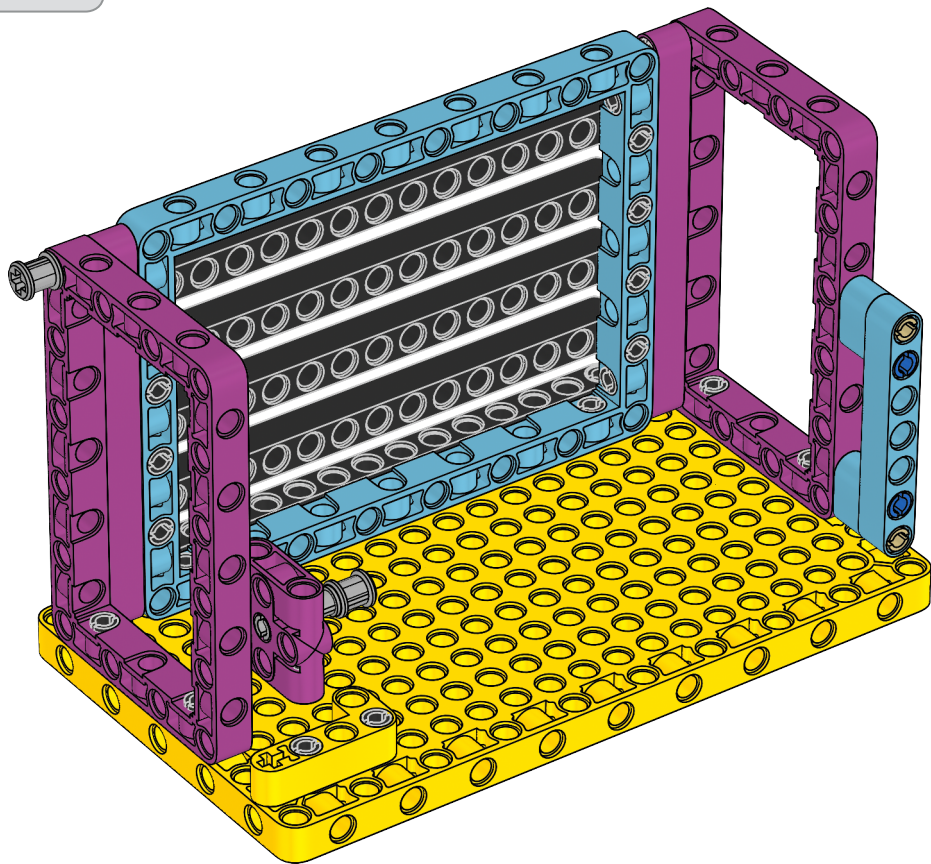

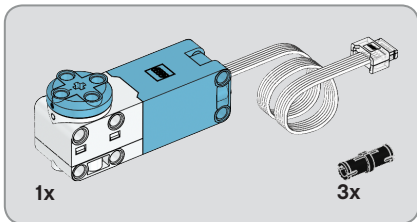
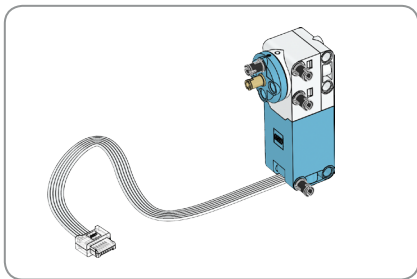

22

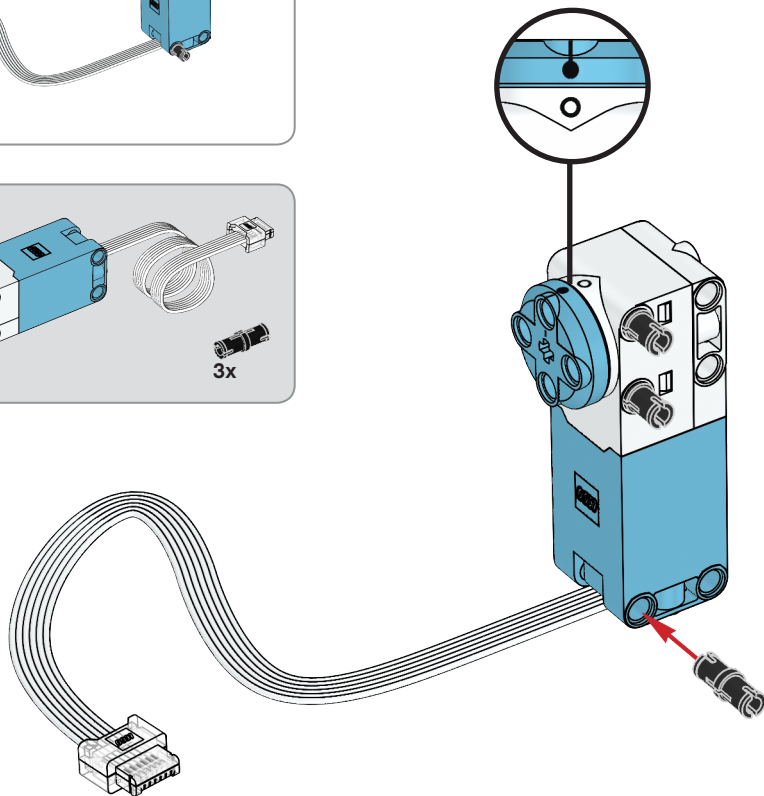



23

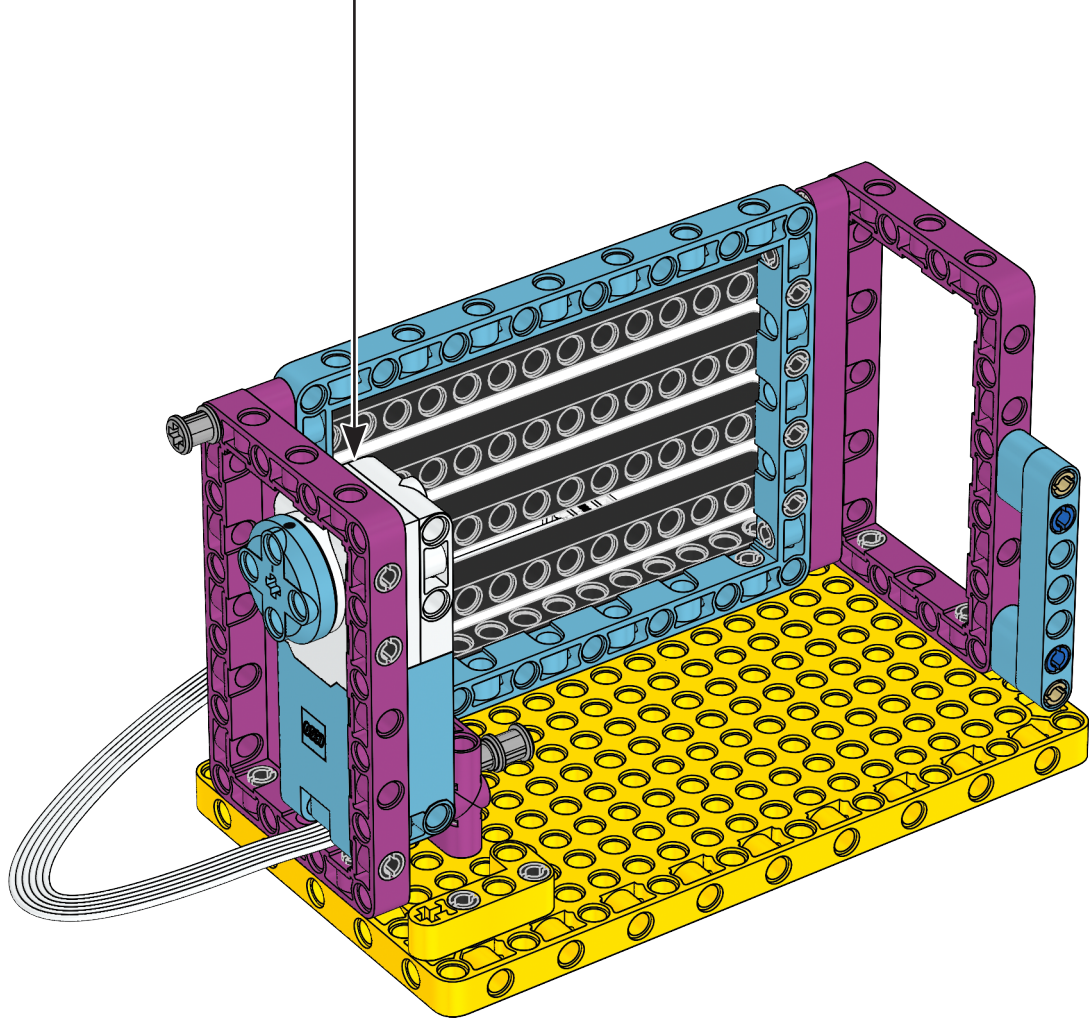

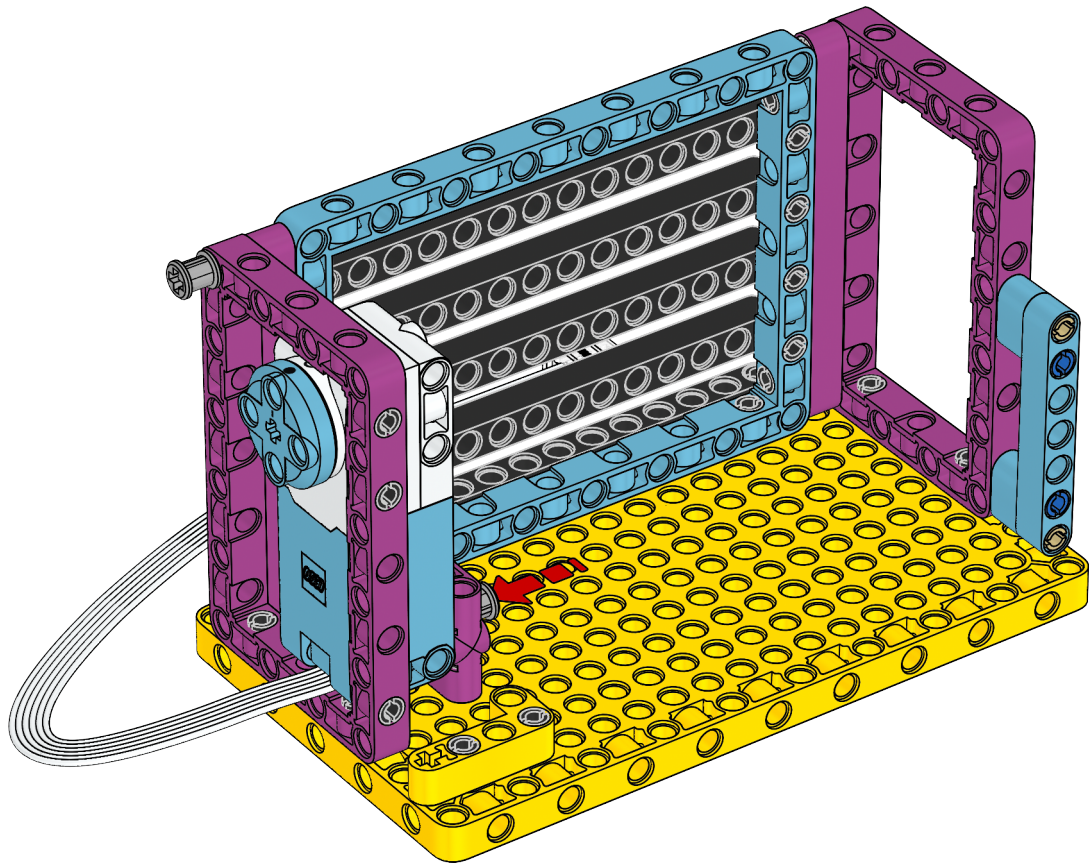



1x



1x

25

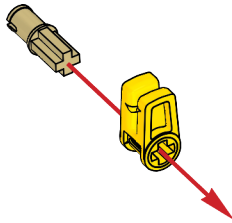

26

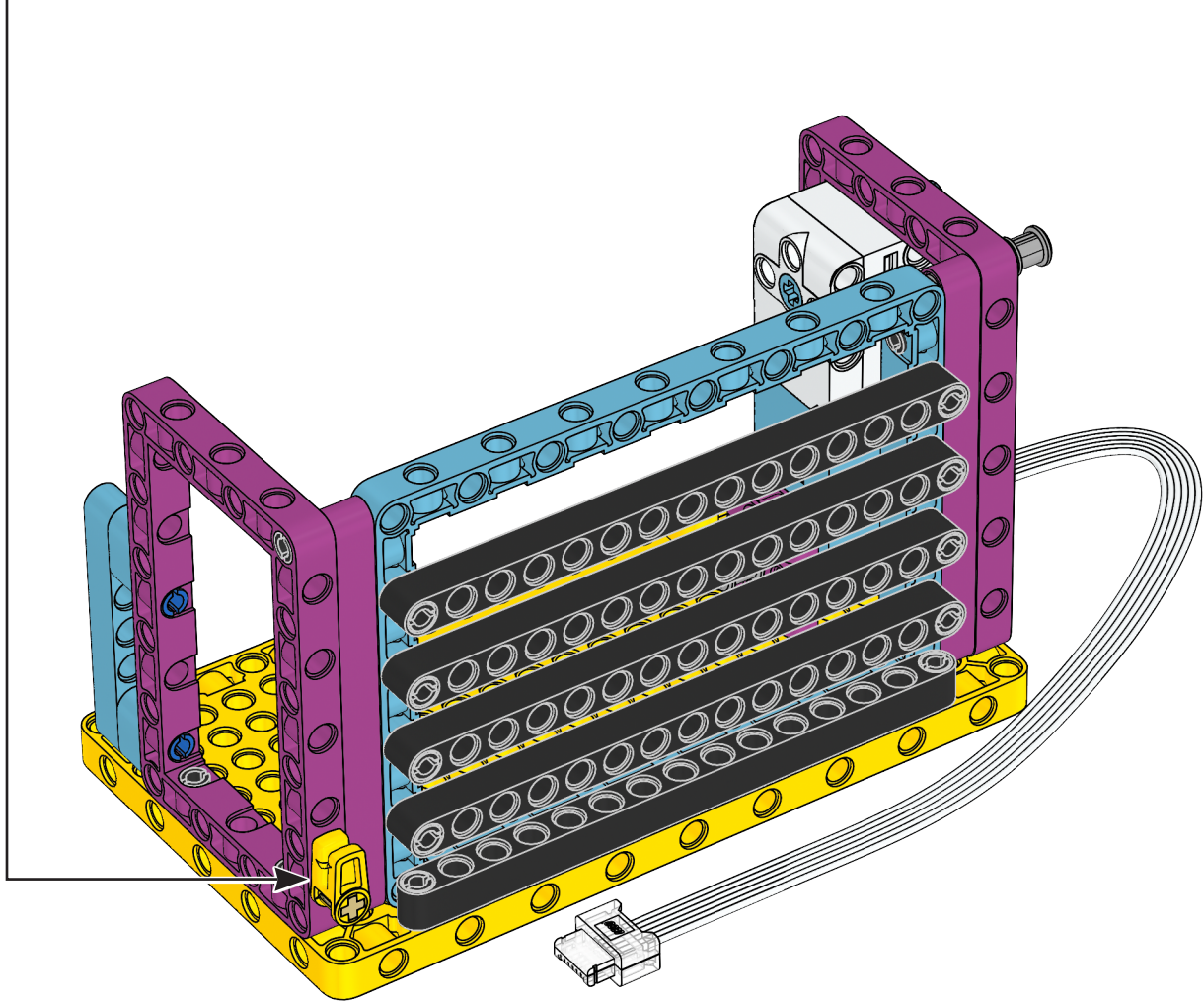

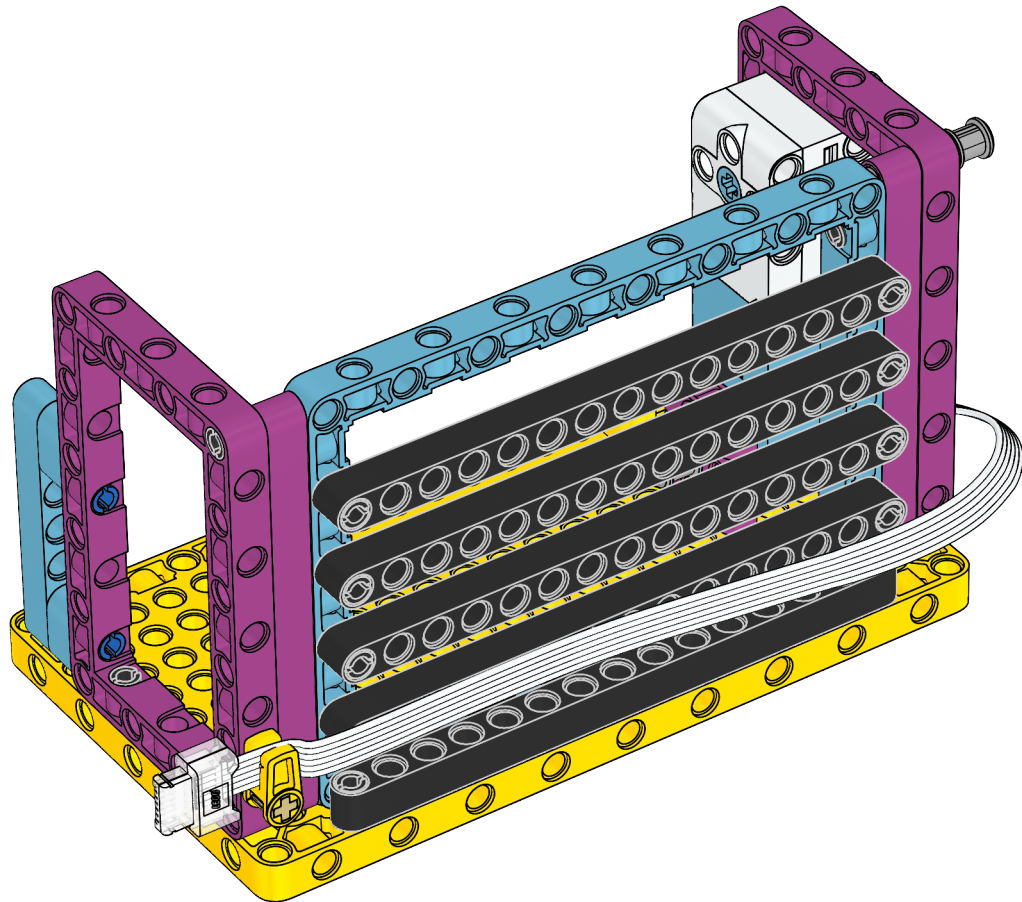

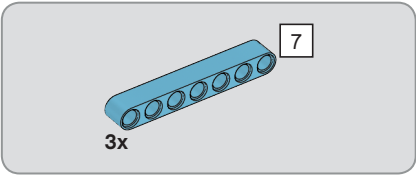
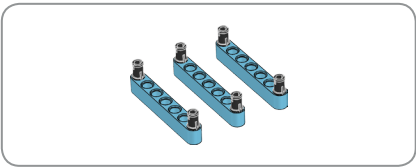

28

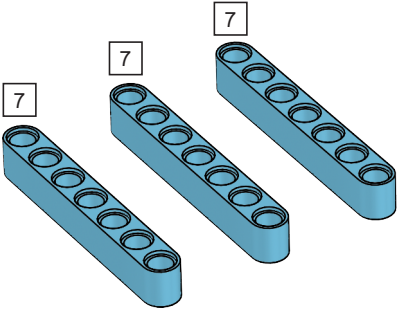



6x

29

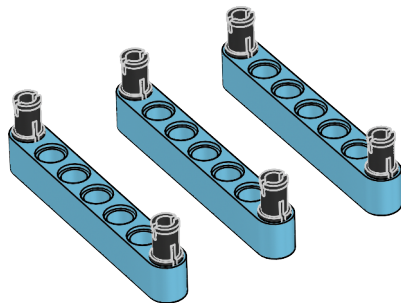

30

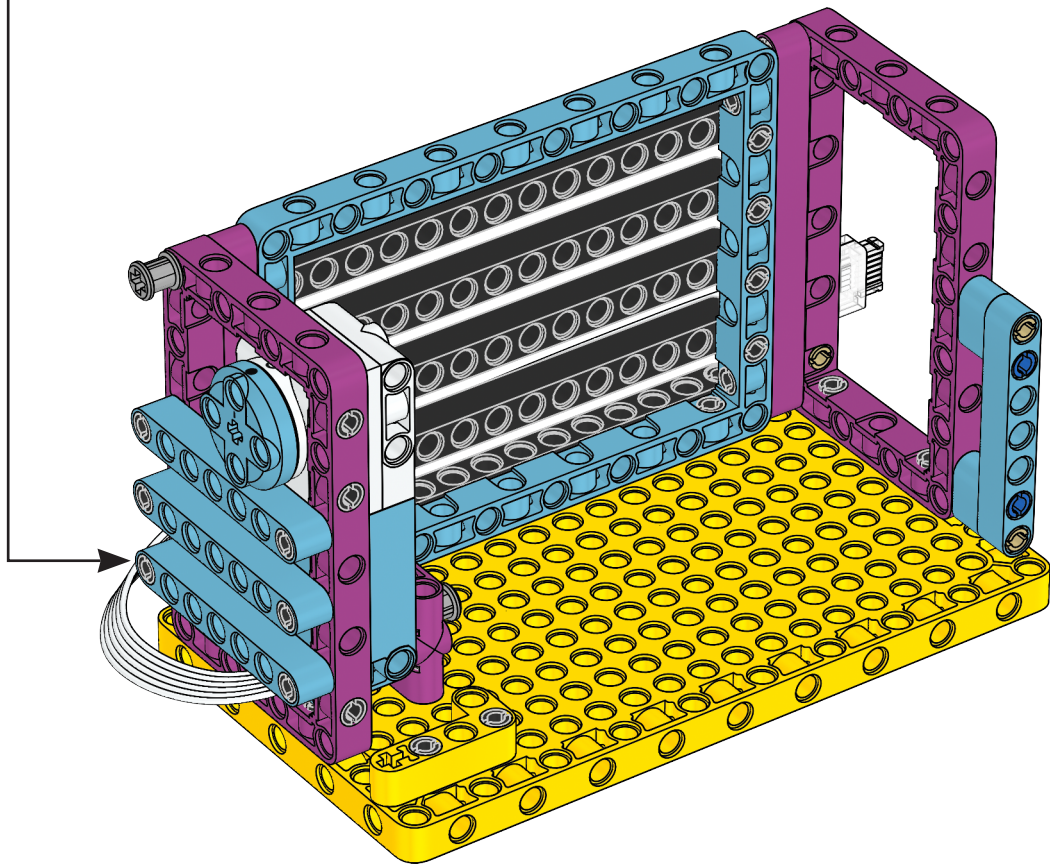





31

