

1

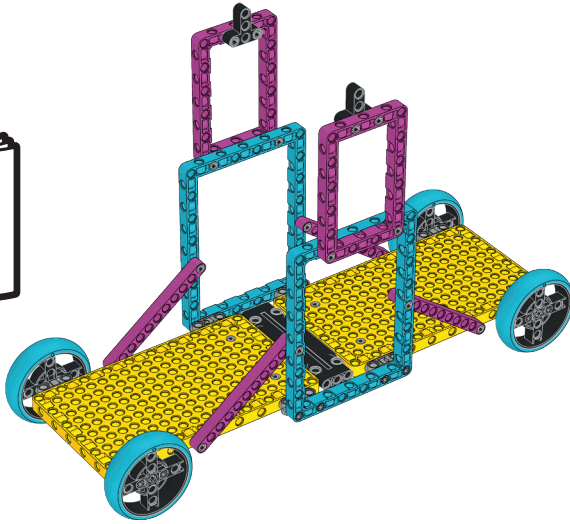

+

2

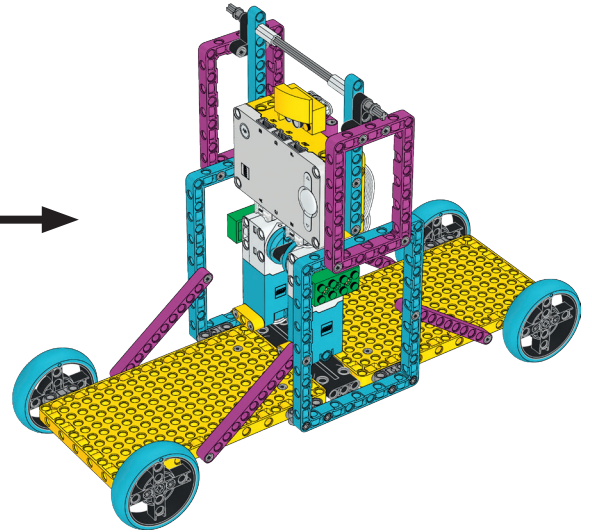
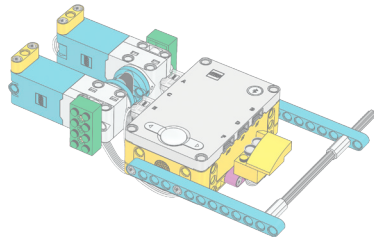

1 x



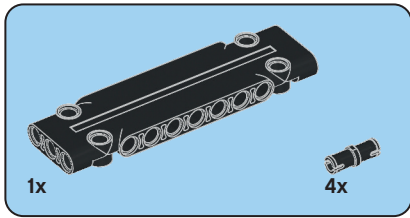

1

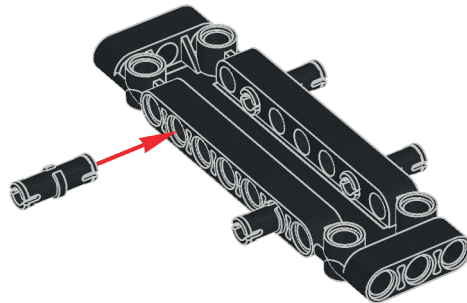

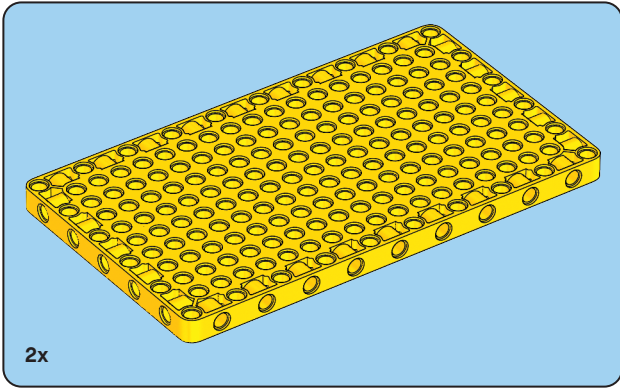

2



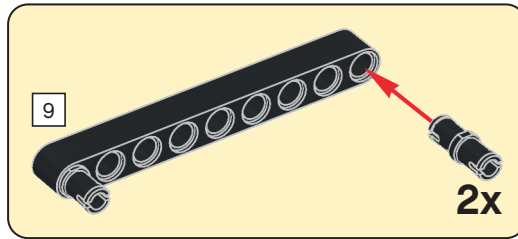
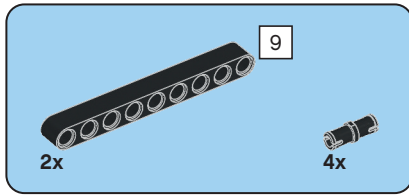

3

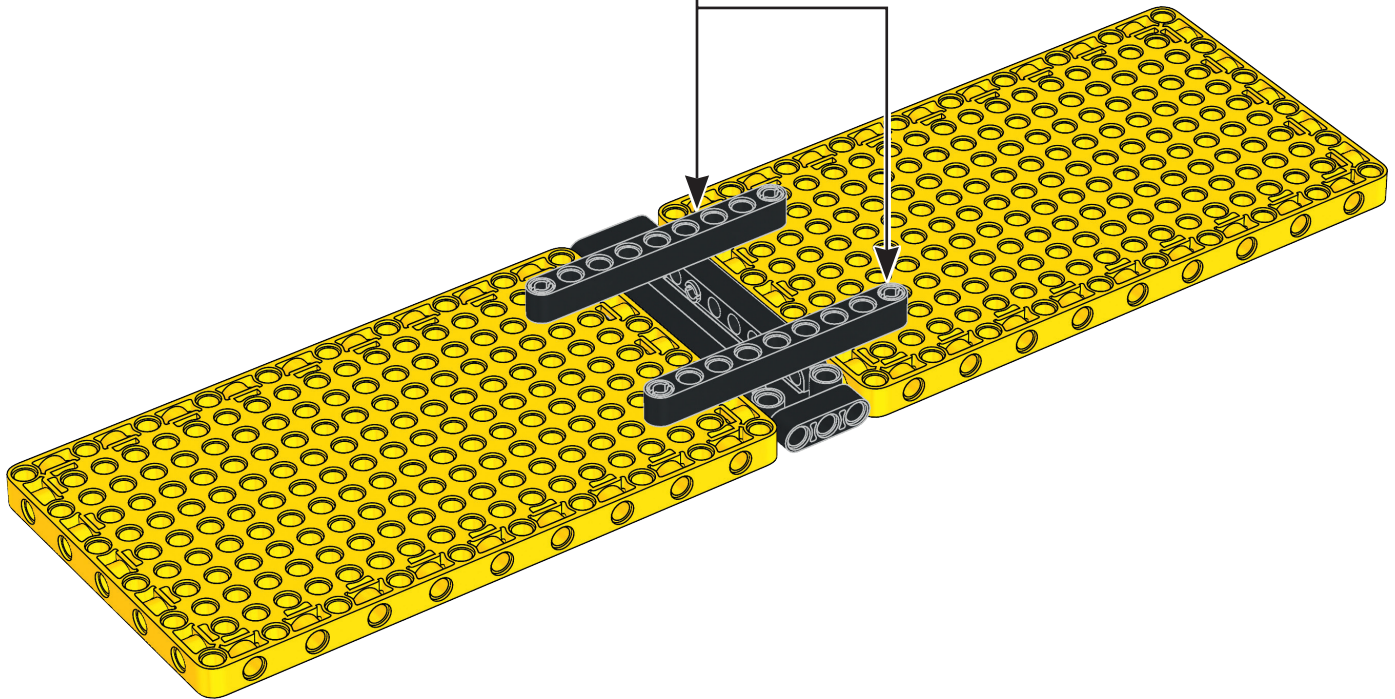

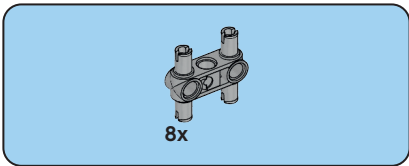

4

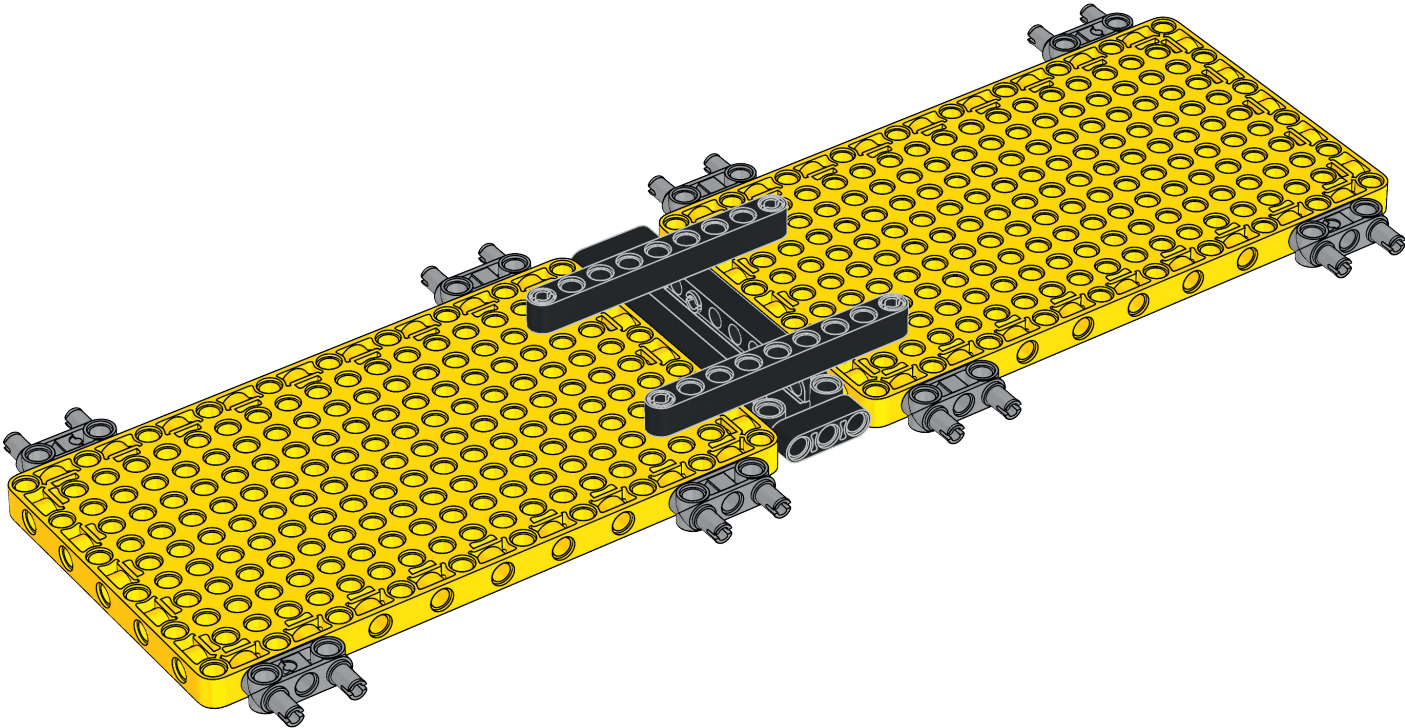



5

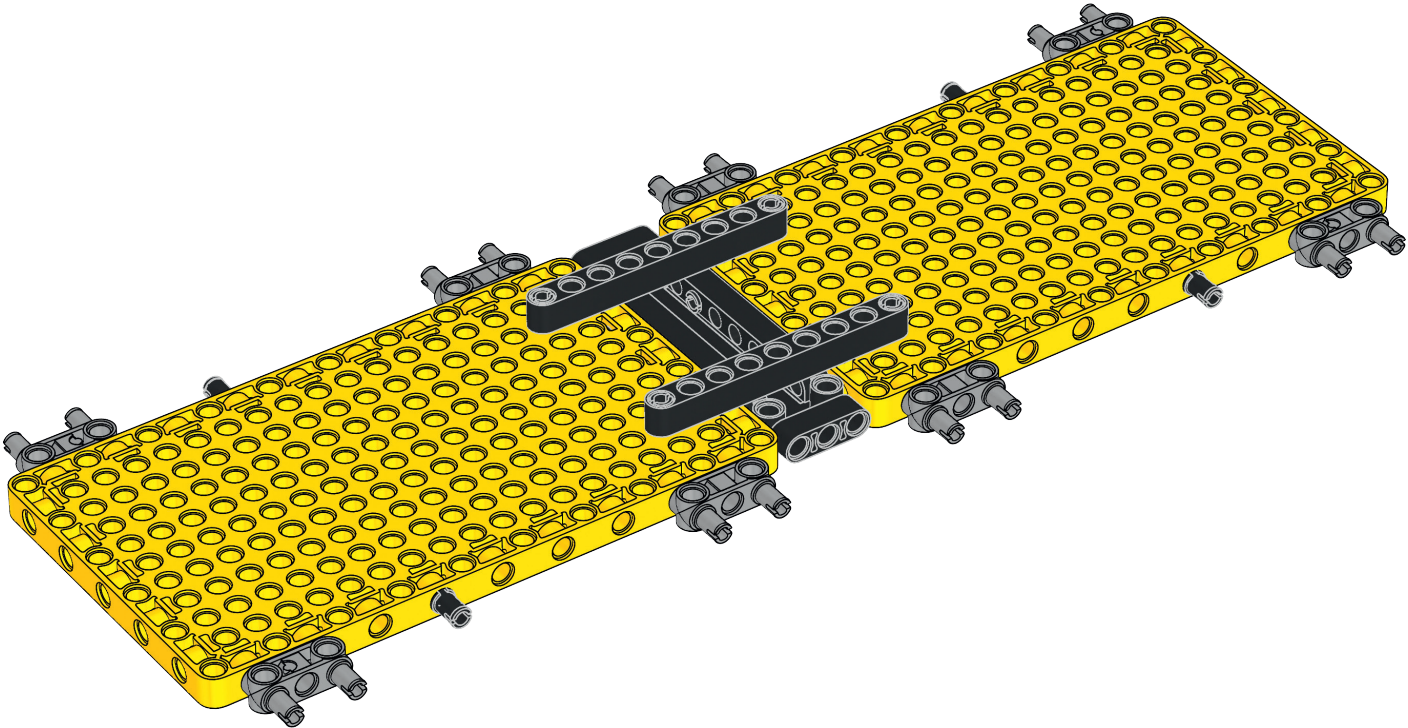

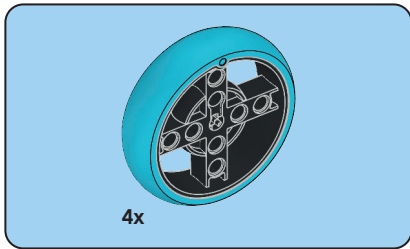

6

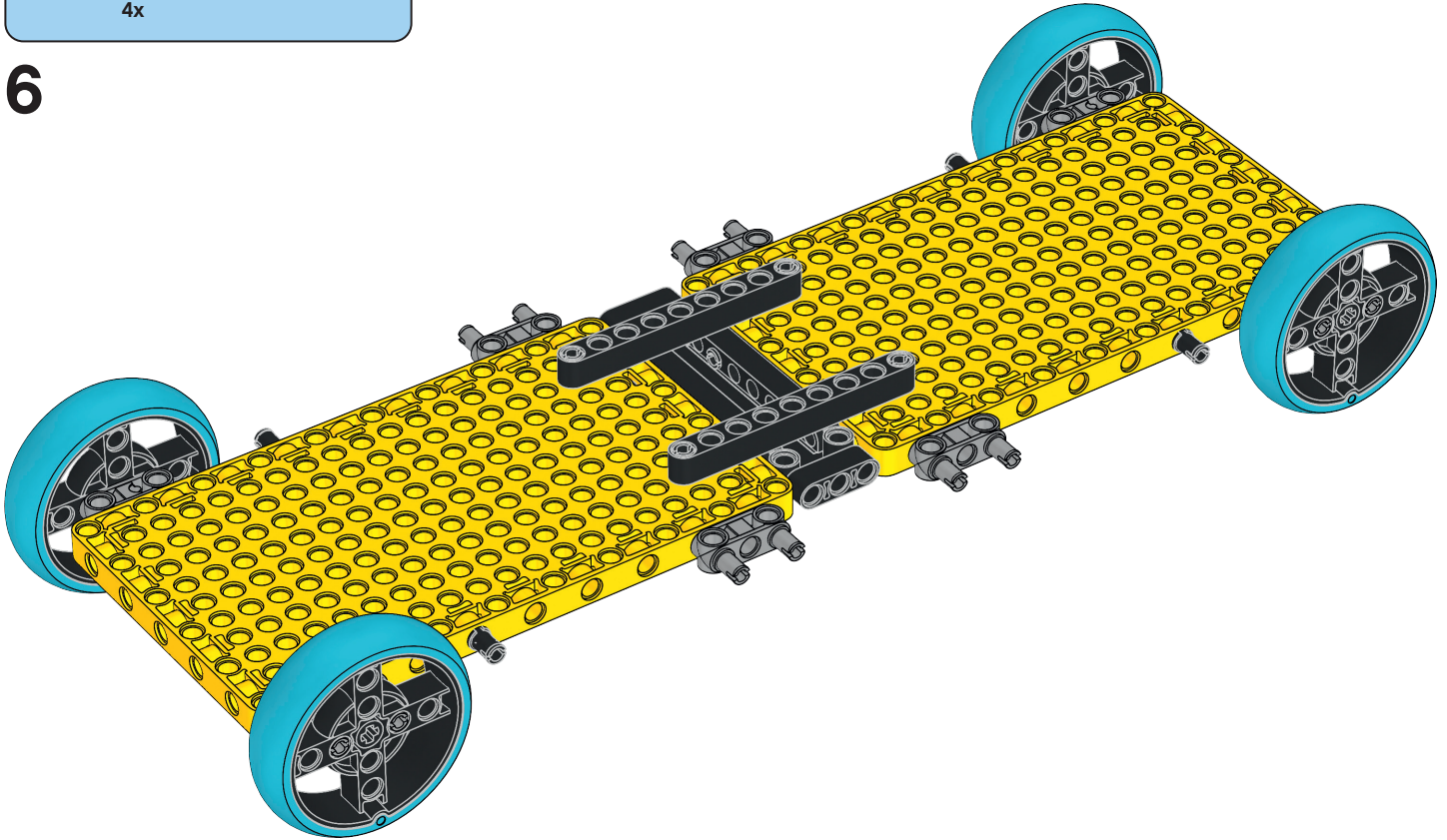

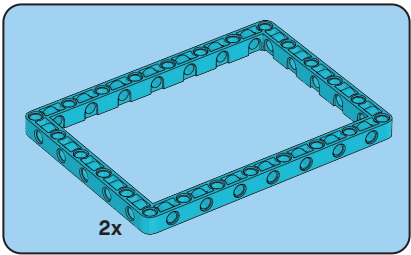

7

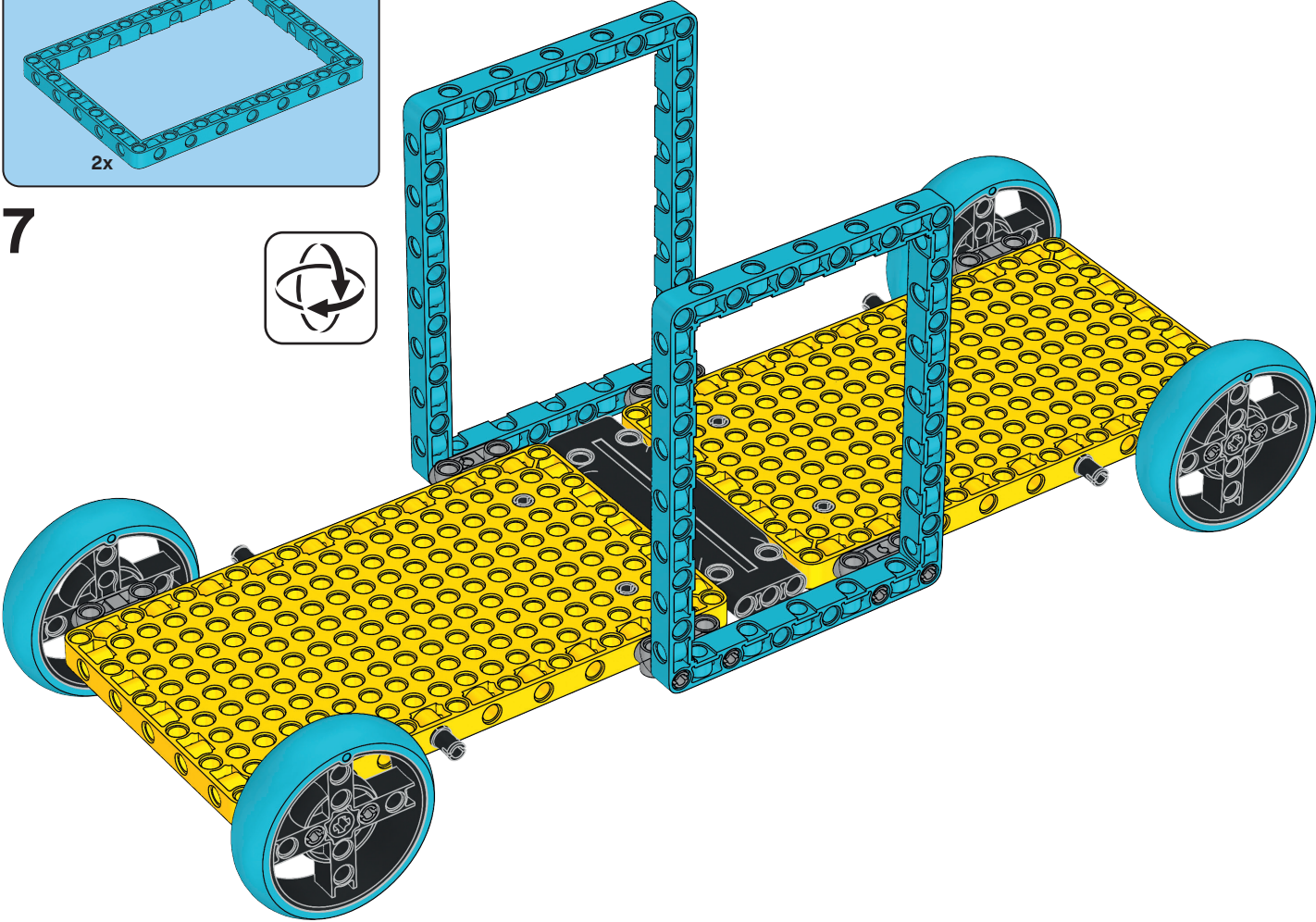

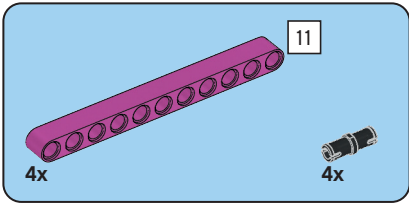
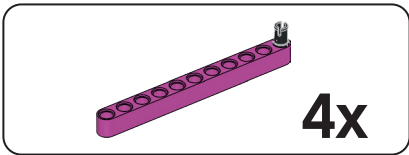

8

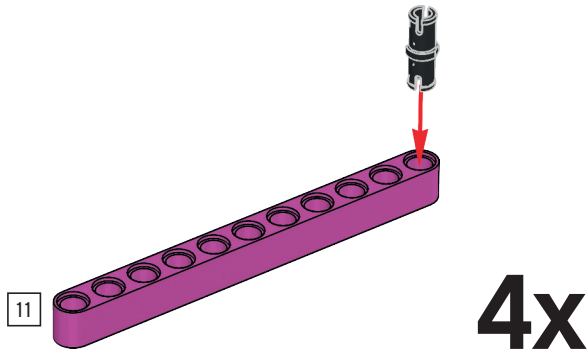

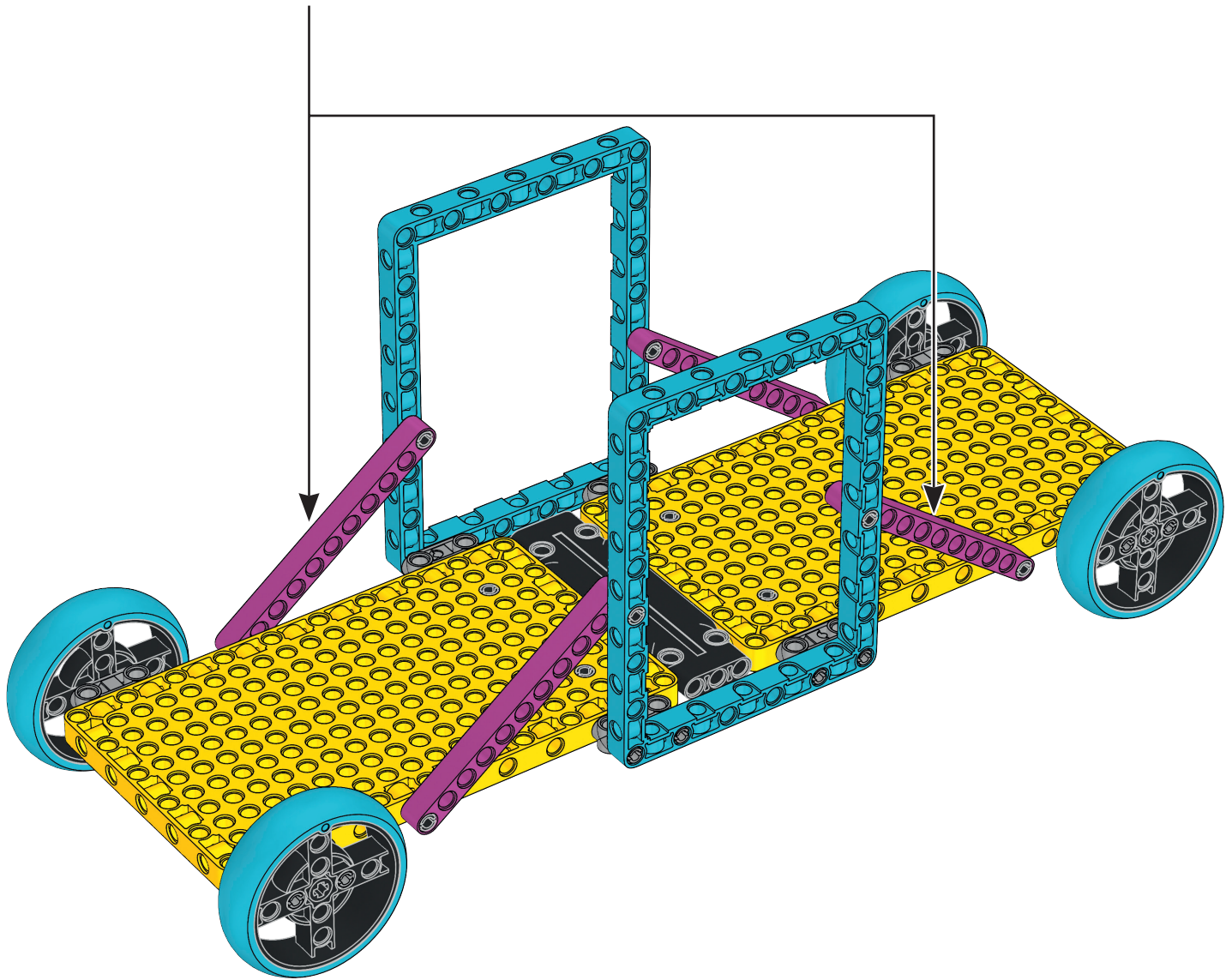

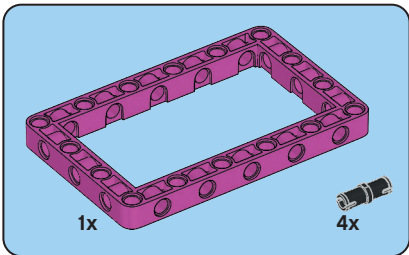
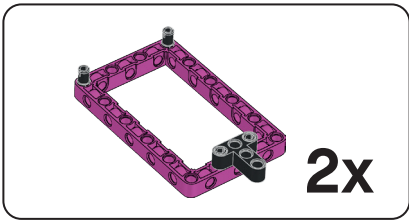

9

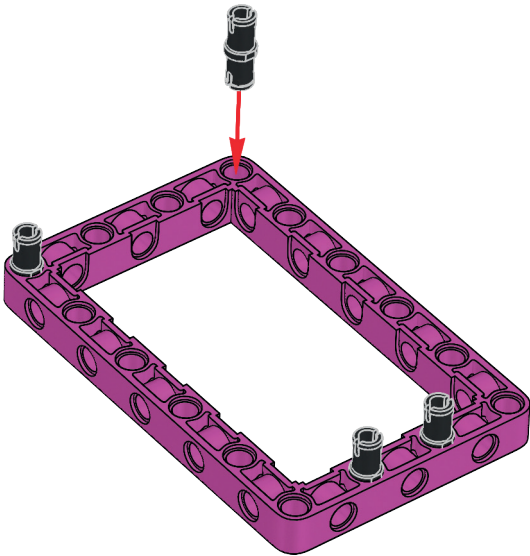

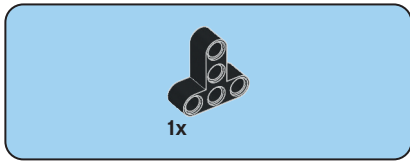

10

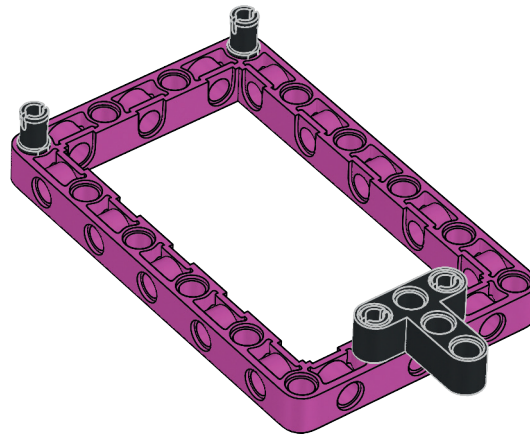

2x

11

