

45300

LEGO and the LEGO logo are trademarks of the/son des marques de commerce
du/son marcas registradas de LEGO Group. ©2015 The LEGO Group. 088360.



education



45300

LEGO and the LEGO logo are trademarks of the/son des marques de commerce
du/son marcas registradas de LEGO Group. ©2015 The LEGO Group. 088360.



education

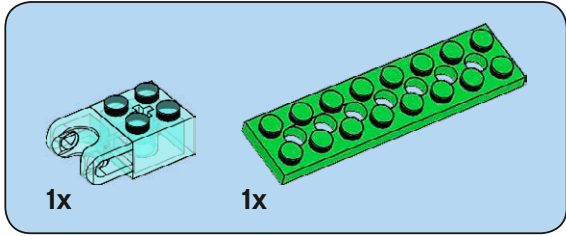

1

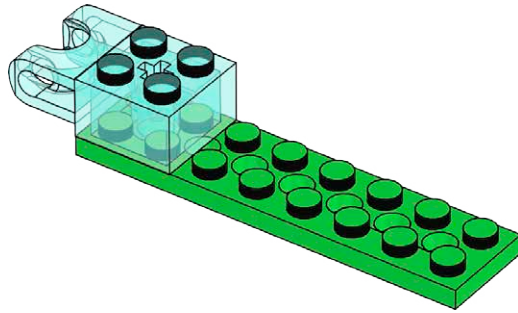

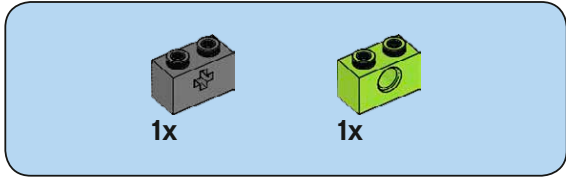

2

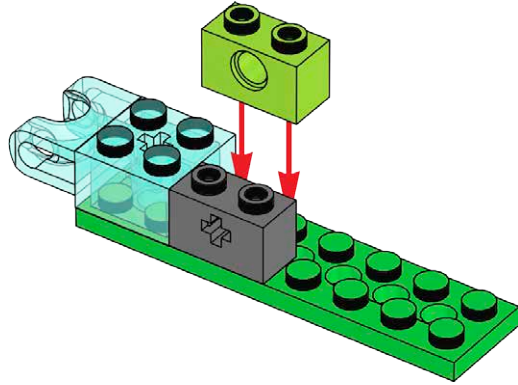

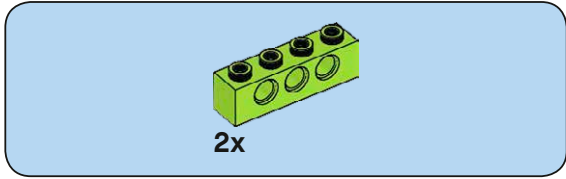

3

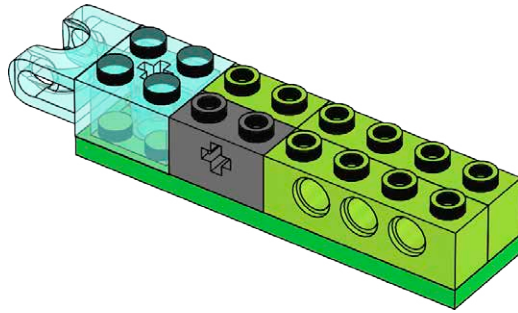

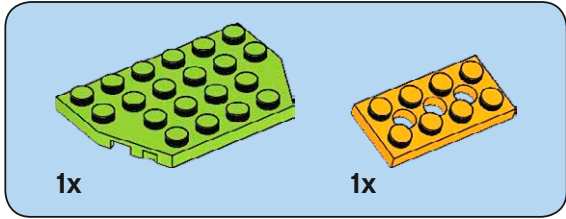

4

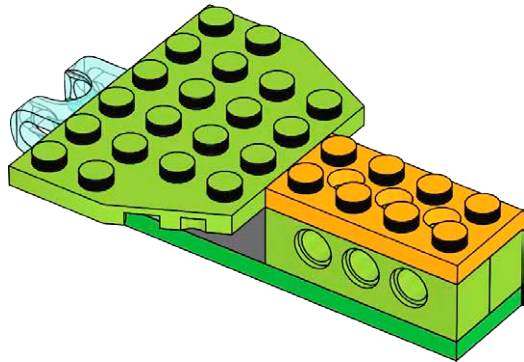

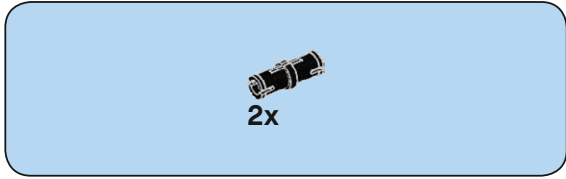

5

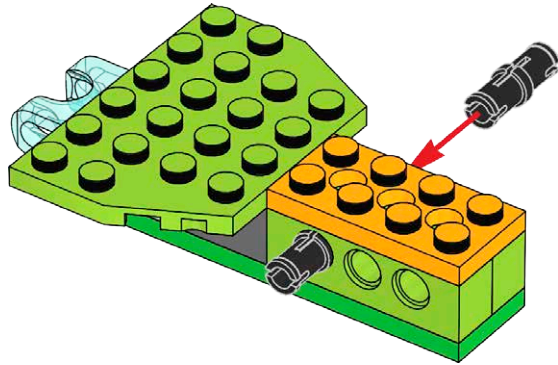

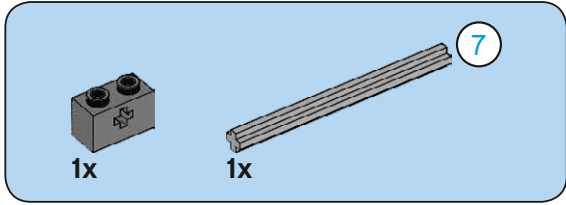

6

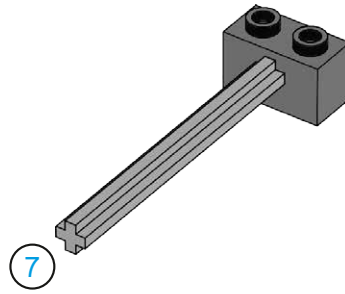

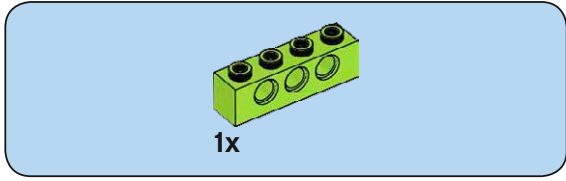

7

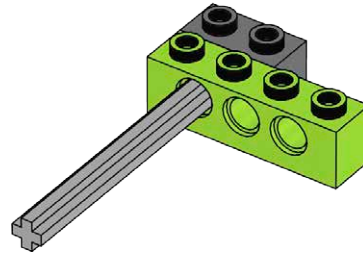

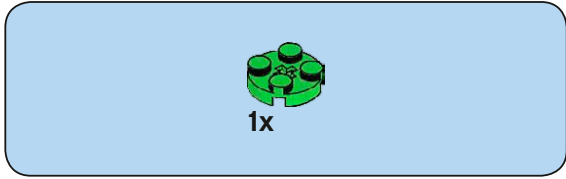

8

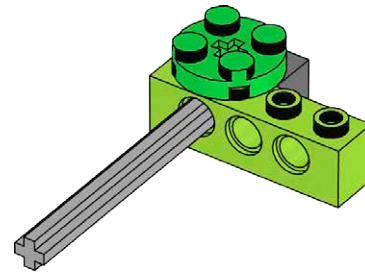

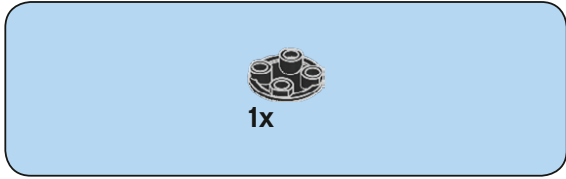

9

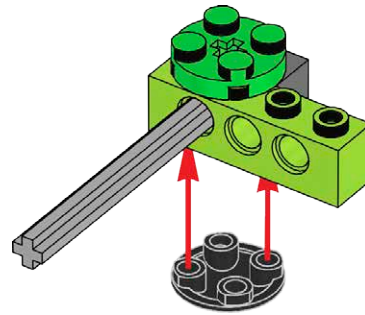

10

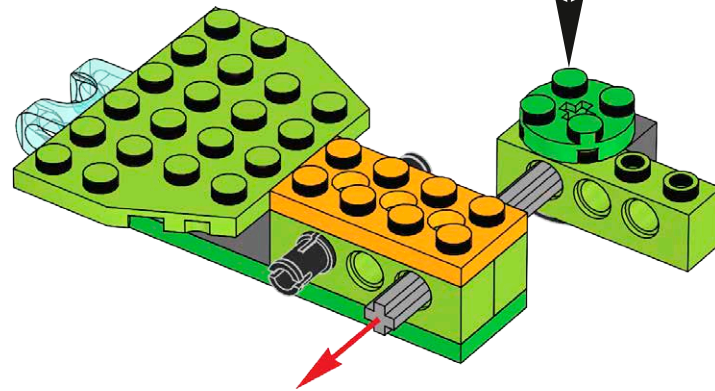

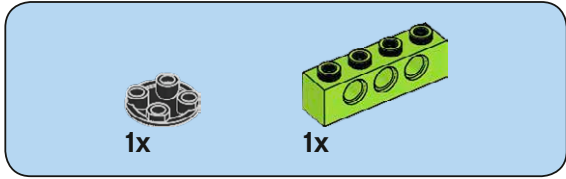

11

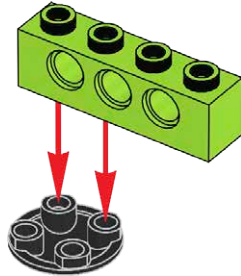

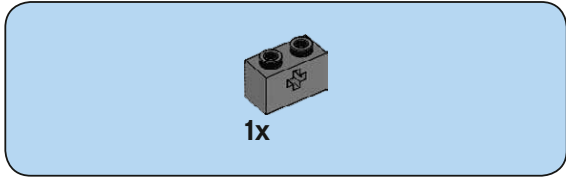

12

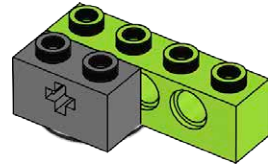

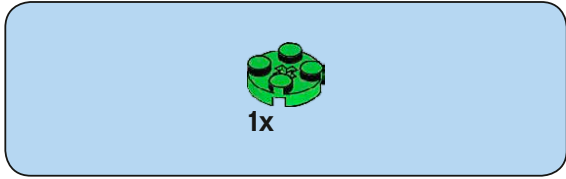

13

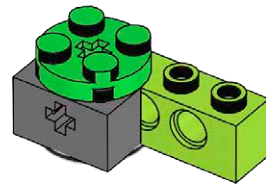

14

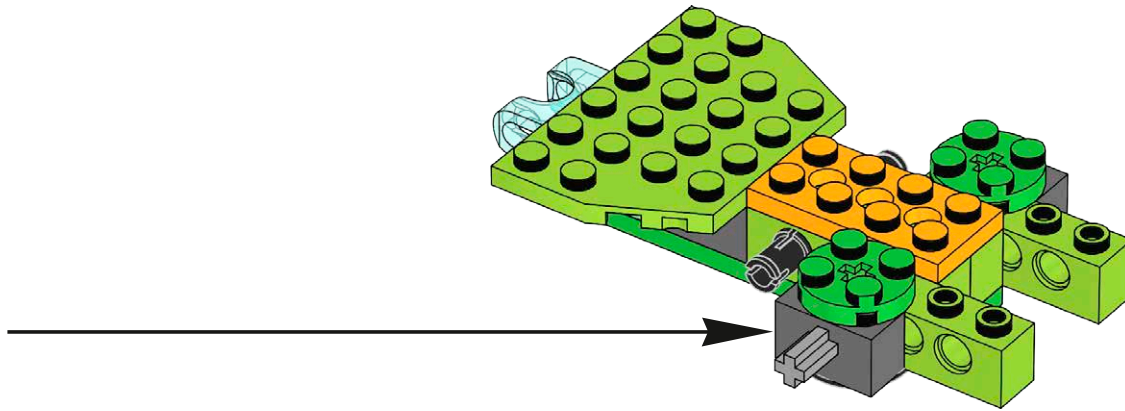

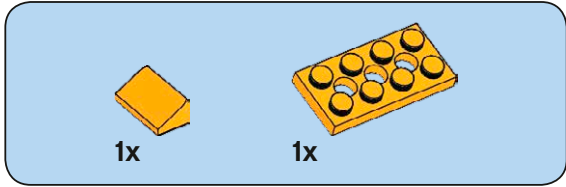

15

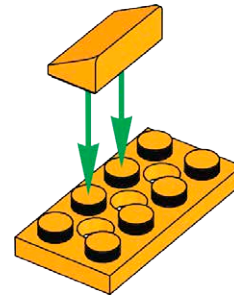

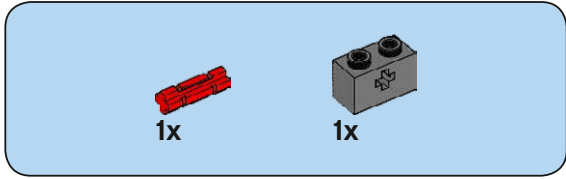

16

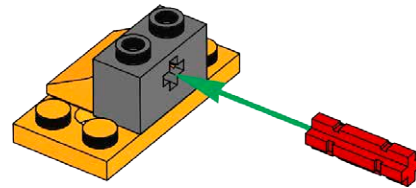

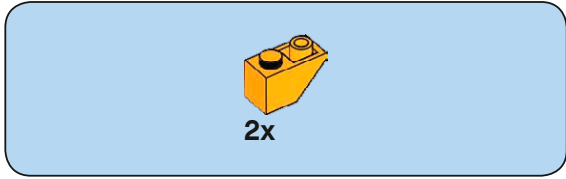

17

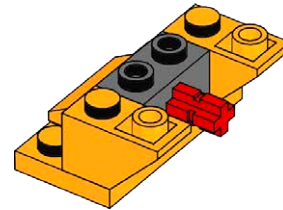

18

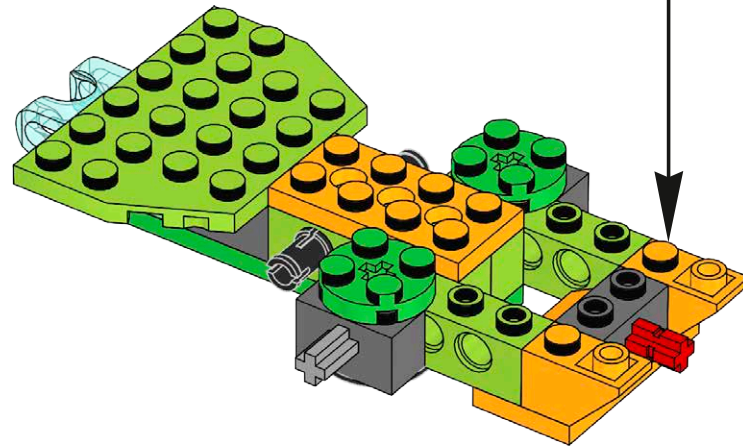

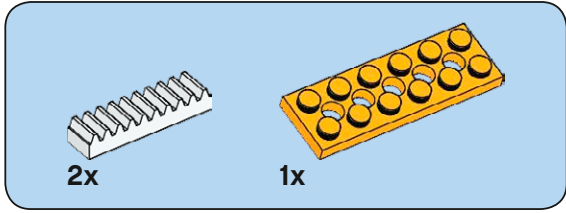

19

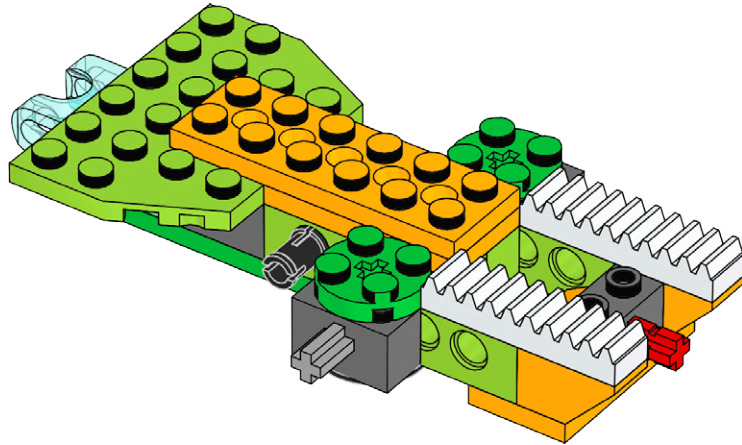

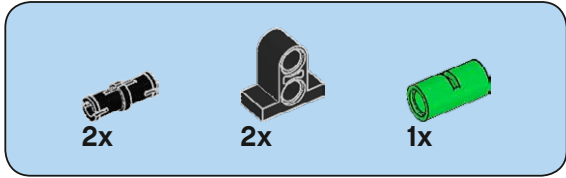

20

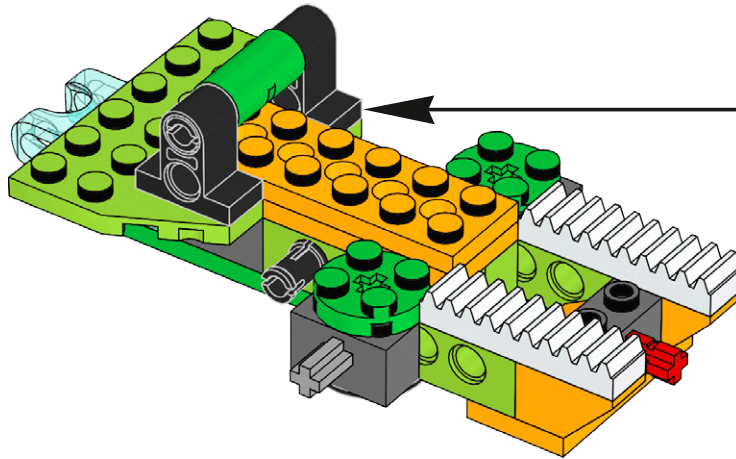
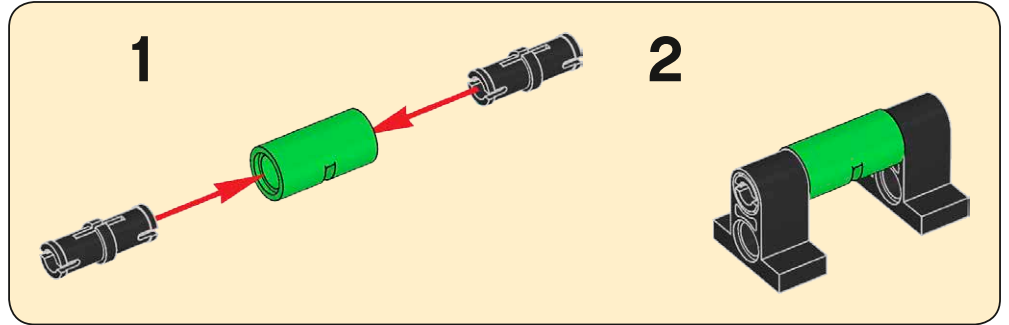

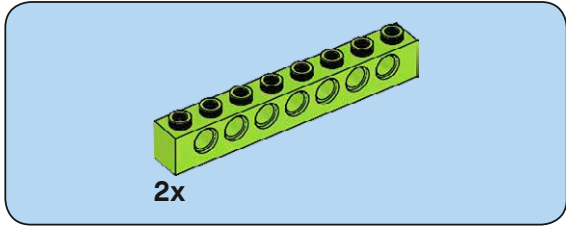

21

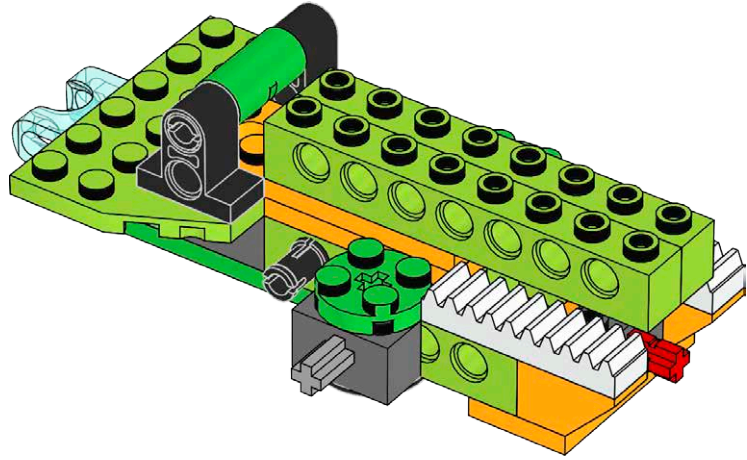

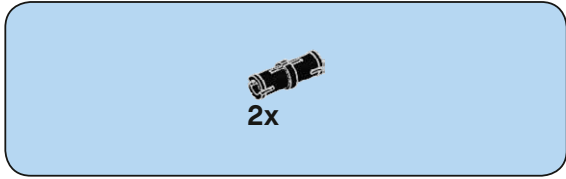

22

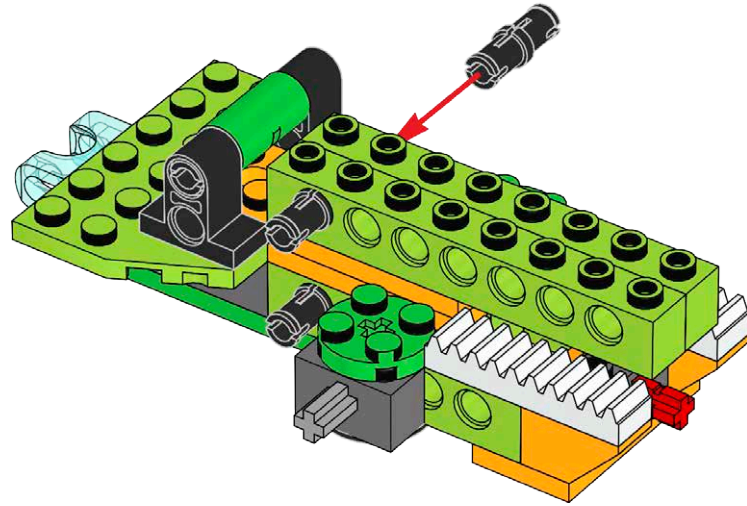

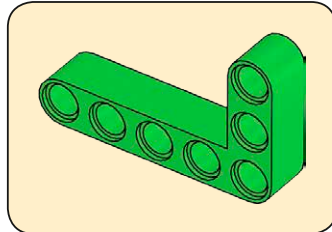
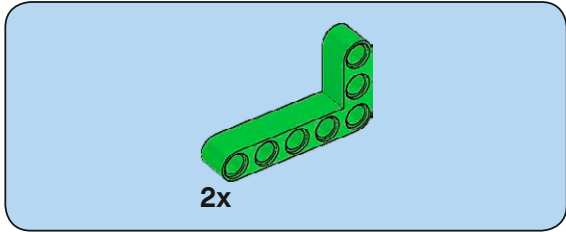

23

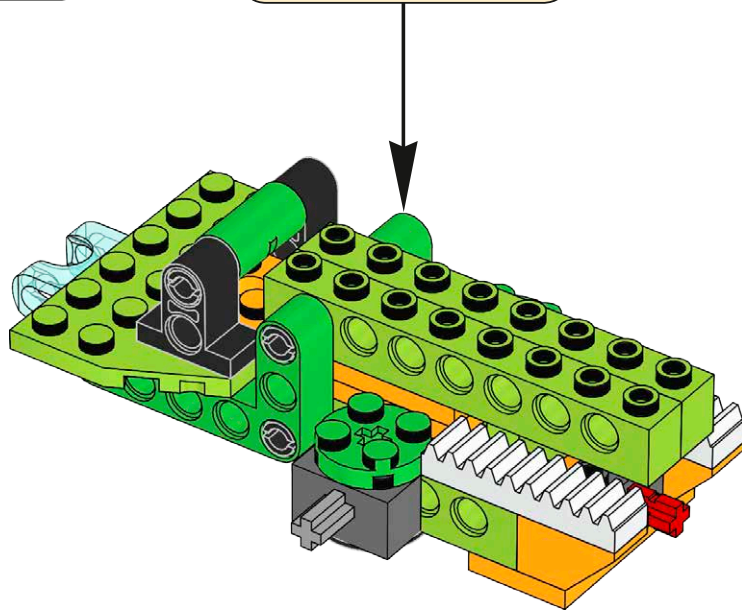

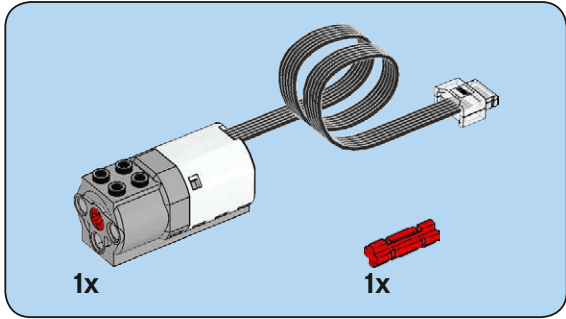

24

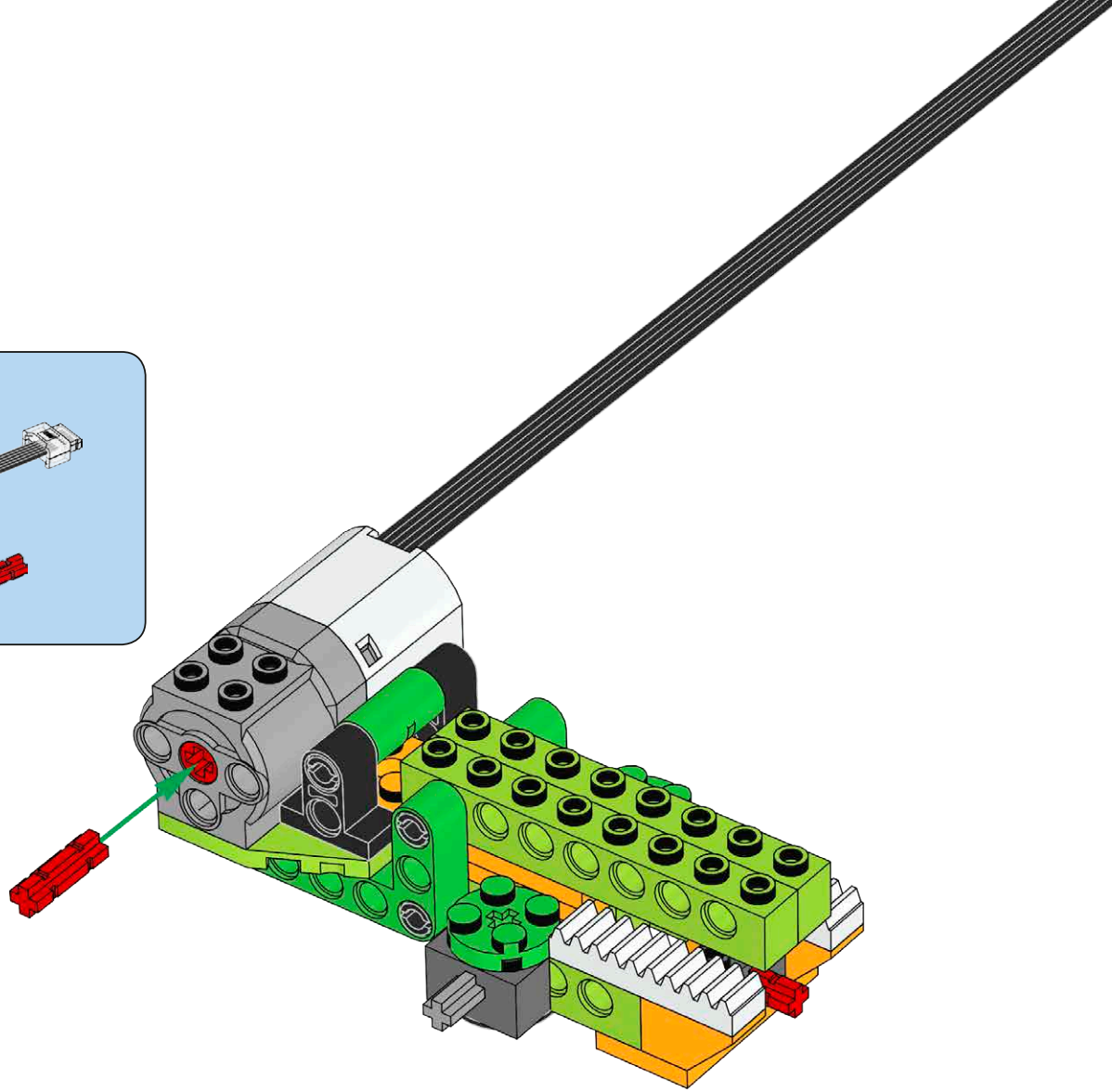

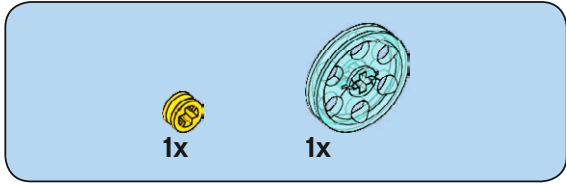

25

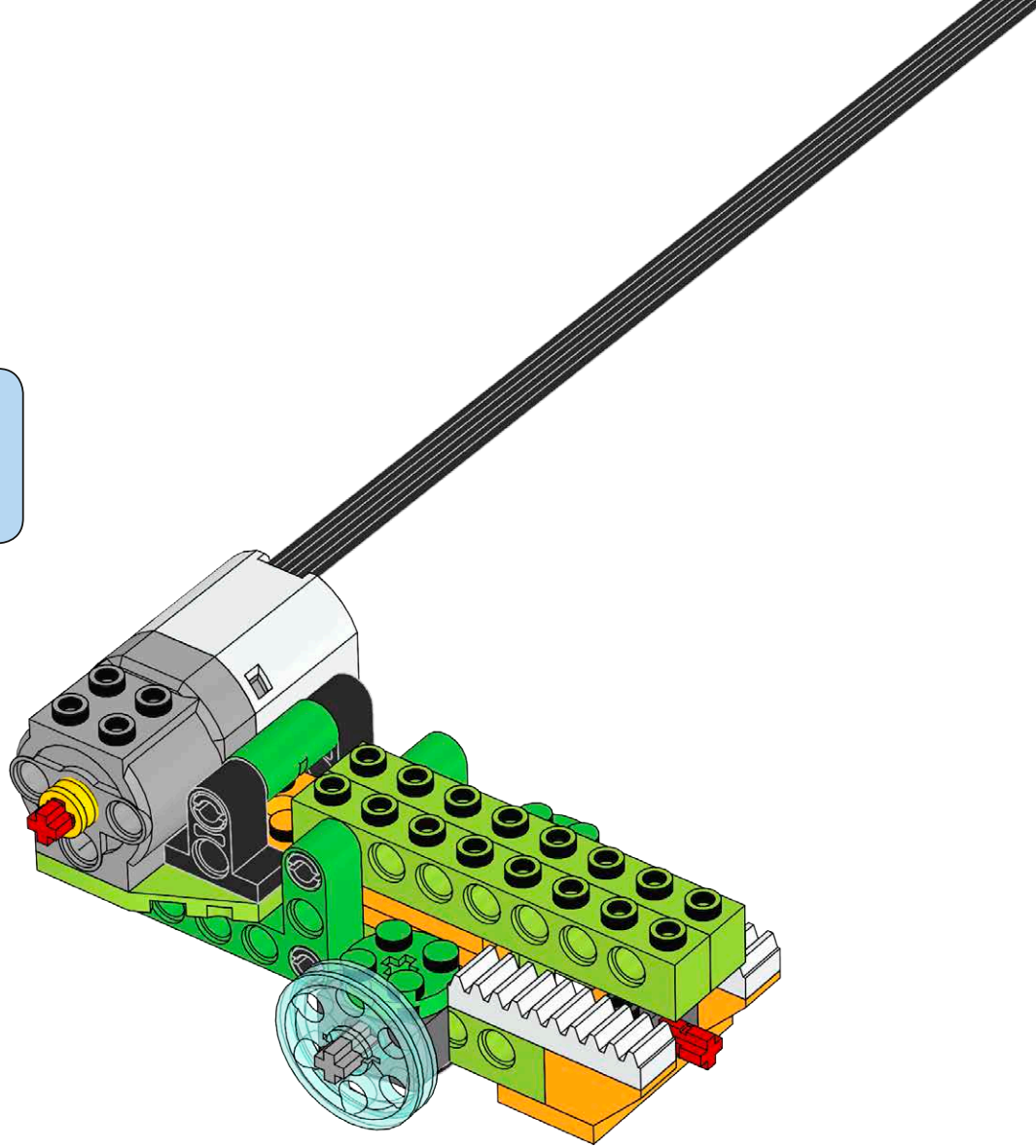

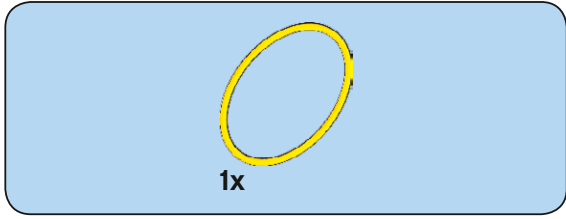

26

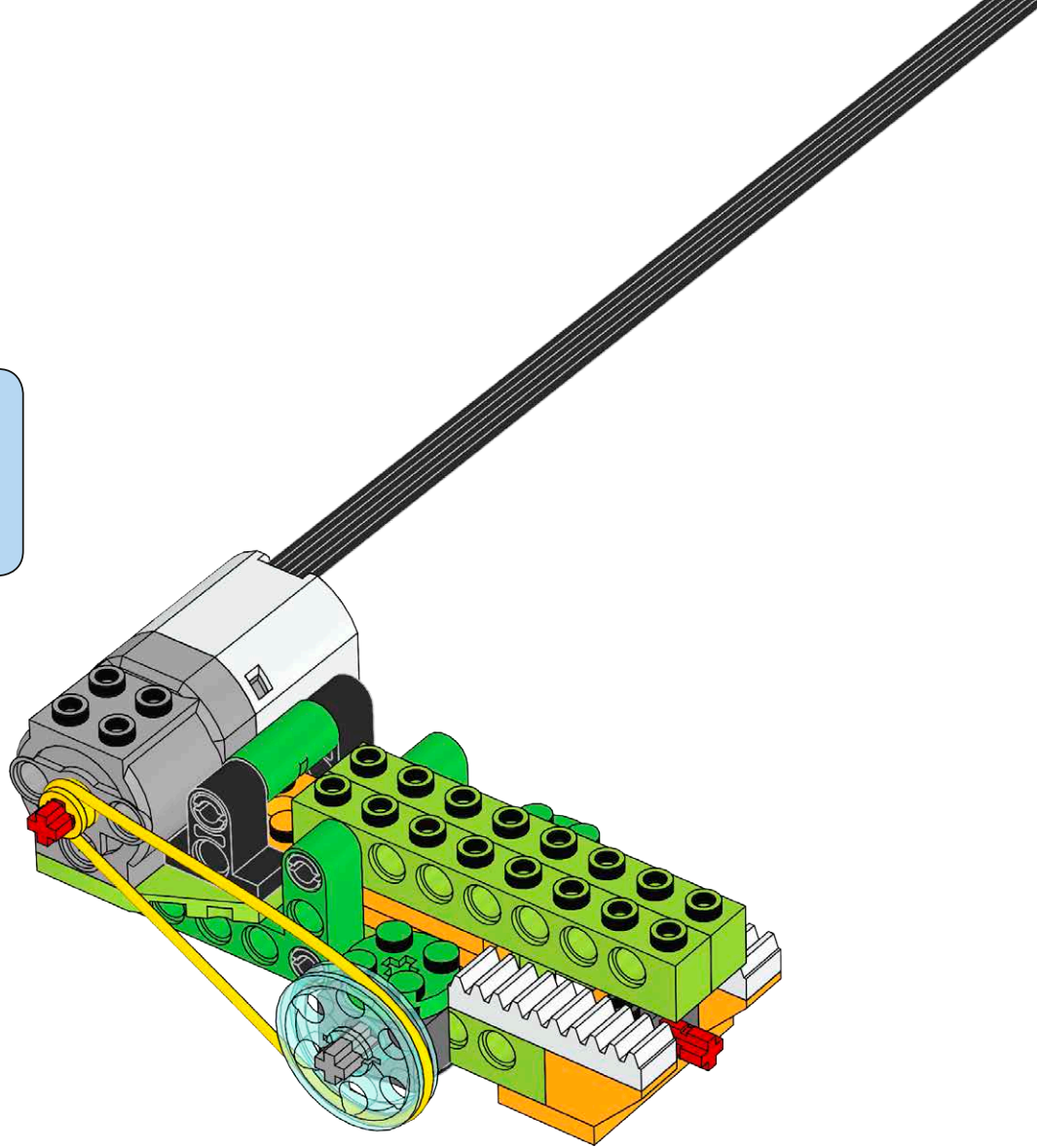

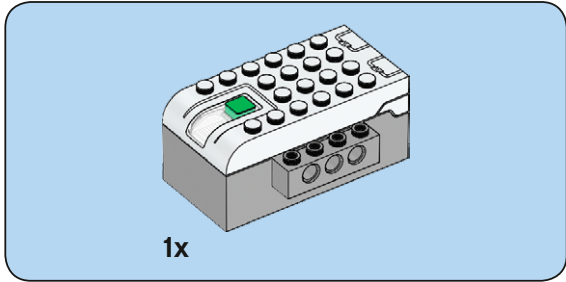

27

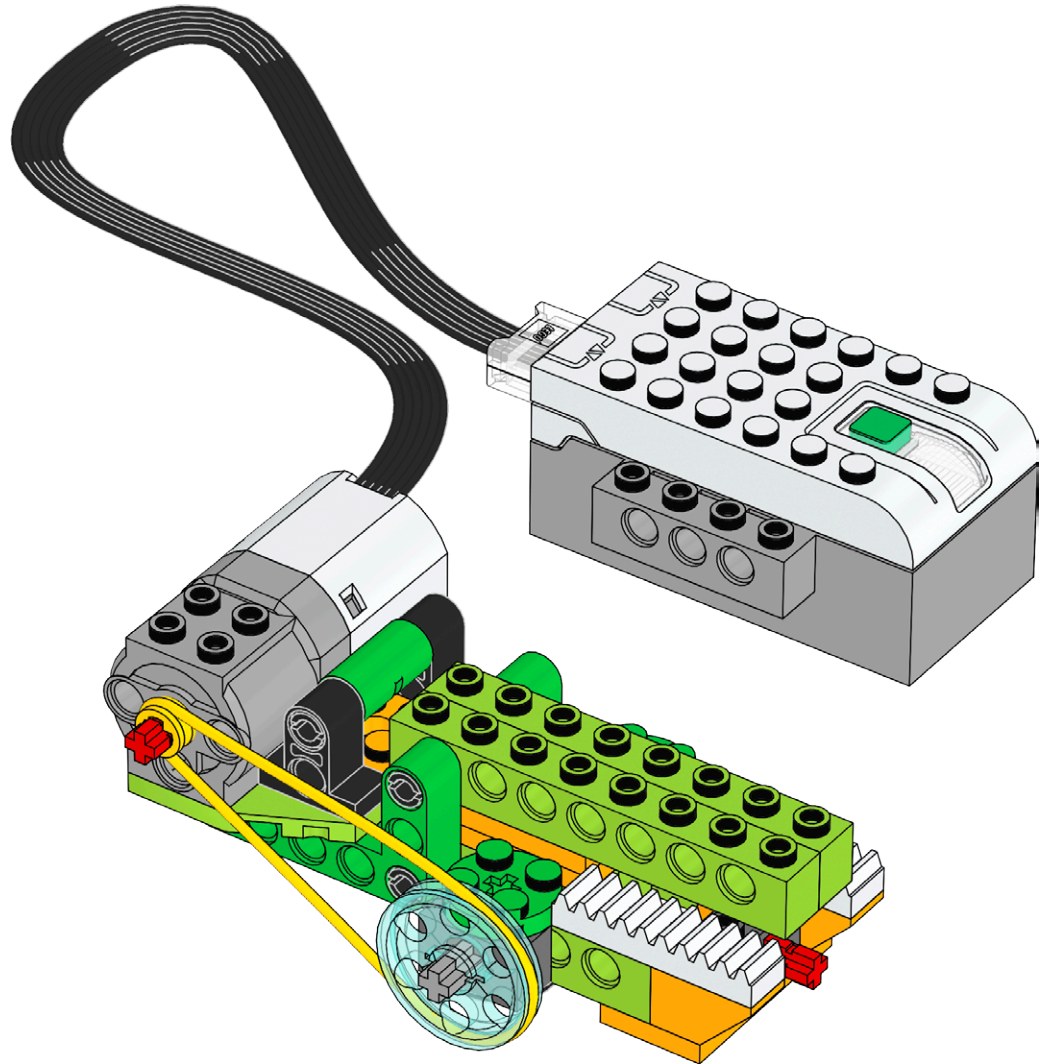

28

