

LEGO® Education WeDo 2.0 Toolbox



WeDo 2.0

Table of Contents

Program with WeDo 2.0
3-21

Build with WeDo 2.0
22-36



Program with WeDo 2.0

Programming is an important part of twenty-first century learning, and it is an essential part of all WeDo 2.0 projects.

It gives life to the models students have created and teaches them computational thinking.





Designing Solutions with LEGO® Programming Blocks

The WeDo 2.0 projects will take you and your students on a journey of using programming concepts to activate models and to create innovative solutions. These programming concepts have been organized by function in the Design Library.

These instructions are provided to inspire your students as they look for solutions. All of these functions can be used as described, or modified to suit a more specific need.

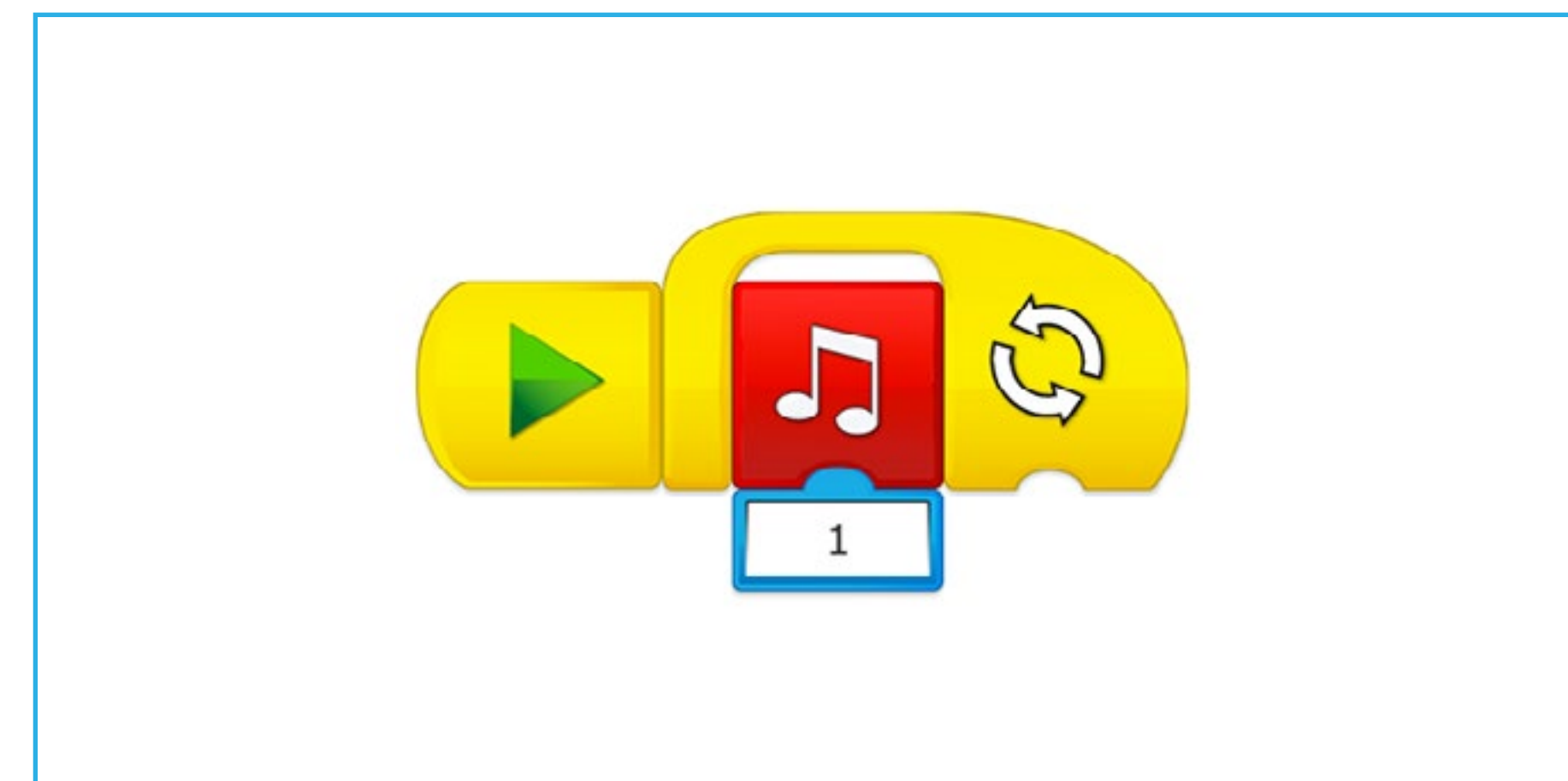
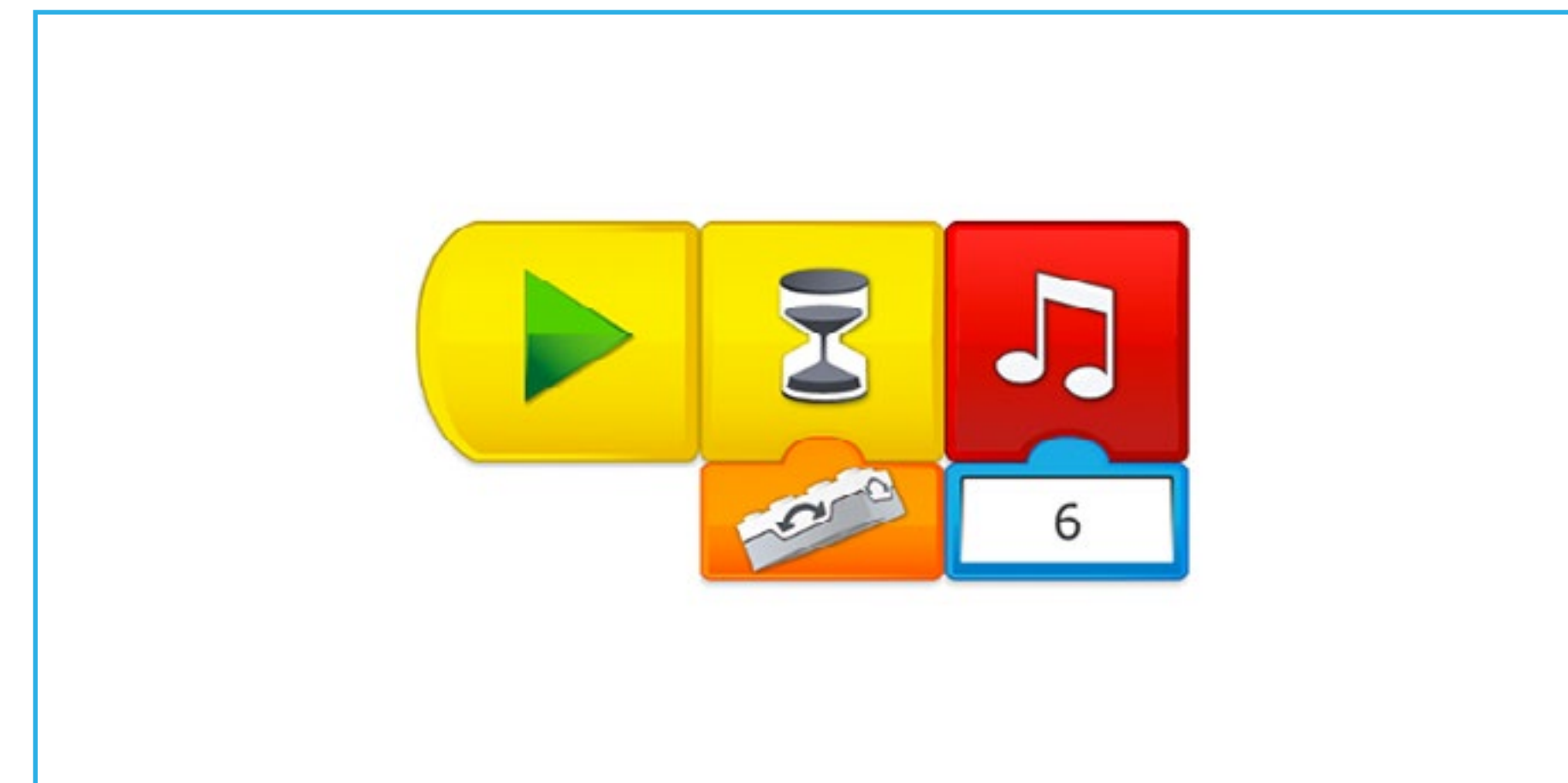



Introduction to a WeDo 2.0 Program String

When students want to bring their models to life, they will drag and drop blocks onto the Programming Canvas. As they do this, your students will be creating program strings. They can create multiple program strings on the canvas, but each of the strings will need to begin with a Start Block.

Here are some important terms to know:

1. Start Block

A Start Block is required in order to start a program string in WeDo 2.0. “Execute” means to start a series of actions until they are completed.

2. Programming Block

Programming blocks are used in WeDo 2.0 software to build a program string. These blocks with symbols are used instead of text-based code.

3. Program String

A program string is a sequence of programming blocks. The last block of the program string marks the end of the program.





Different Types of Program Strings

When students explore programming for the first time, they will probably line up as many blocks as possible on the Programming Canvas. To carry out an idea they have in mind, they will either arrange their blocks in a flow so that they are executed one after the other, or executed simultaneously.

Here are two important terms to know:

1. Linear Sequence

A linear sequence is when blocks are placed one after the other in a linear fashion. The LEGO® Education WeDo 2.0 software will then execute one action after the other in the order in which the blocks have been placed.

2. Parallel Sequence

A parallel sequence should be used when students want to perform two or more actions simultaneously. In this case, the actions should be placed on different program strings and executed at the same time, using the various techniques available in WeDo 2.0.

Suggestion

Tell your students to plan their programs in advance. This will help them when they are deciding the order in which the program actions should take place. They could use the Documentation tool to write the actions they wish to program, step-by-step. They could also use a mind map of their own to decide whether they should use a linear sequence or a parallel sequence.





Programming Principles

In developing program strings as part of their solutions, students will organize a series of actions and structures that will make their models come to life.

Here are some of the simplest programming principles your students can use:

1. Output

Output is something that is controlled by the program the students are writing. Examples of outputs for WeDo 2.0 are sounds, lights, display, and turning motors on and off.

2. Input

Input is information that a computer or device receives. It can be inputted through the use of sensors in the form of a numeric or text value. For example, a sensor that detects or measures something (such as distance) converts that value into a digital input signal so it can be used in a program.

3. Events (Wait for)

Students can tell their program to wait for something to happen before continuing to execute the sequence of actions. Programs can wait for a specific amount of time, or wait for something to be detected by a sensor.

4. Loop

Students can program actions to be repeated either forever or for a specific length of time.

5. Functions

Functions are a group of actions that are to be used together in specific situations.

For example, the group of blocks that could be used to make a light blink would together be called, “the blink function”.

6. Conditions

Conditions are used by students in order to program actions that are to be executed only under certain circumstances. Creating conditions within a program means that some part of the program will never be executed if the condition is never met. For example, if the Tilt Sensor is tilted left, the motor will start, and if the sensor is tilted right, the motor will stop; if the Tilt Sensor never tilts left, the motor will never start and if it never tilts right, then the motor will never stop.

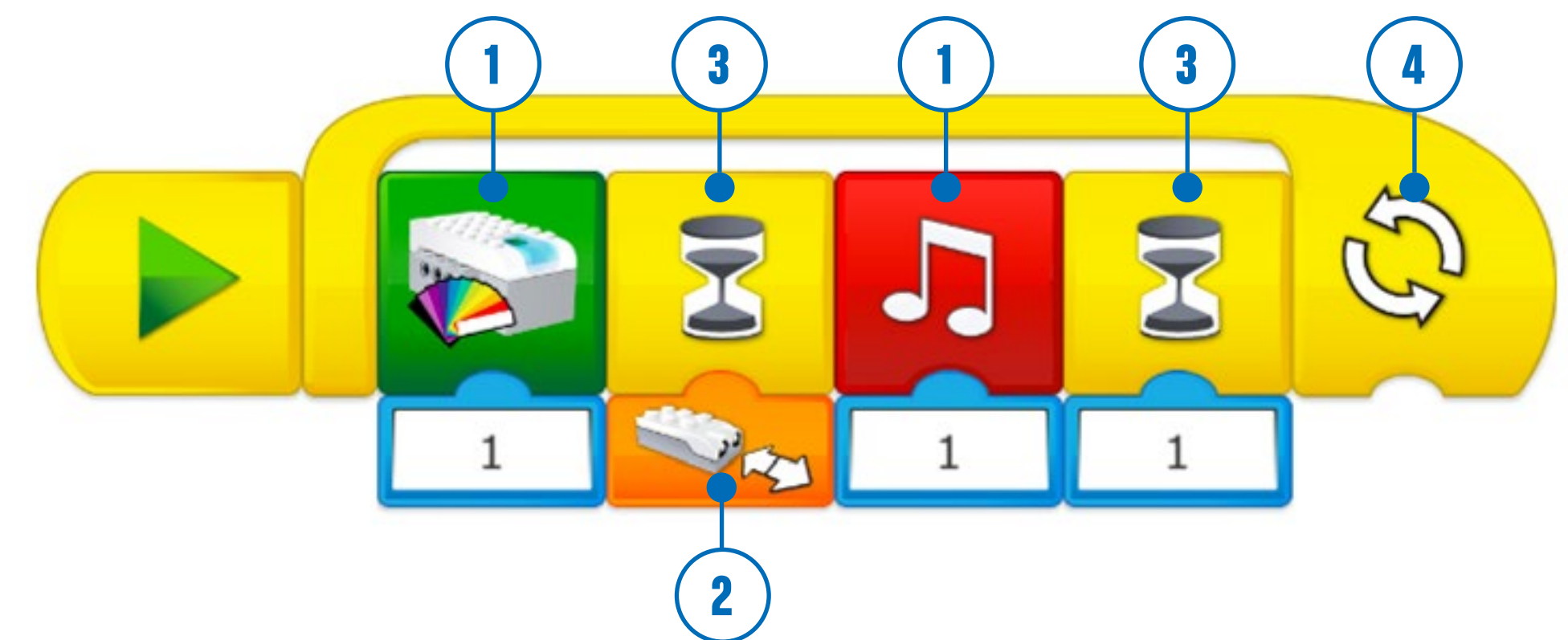



What is Pseudocode?

Program strings are designed for computers to understand, and pseudocode is a way to explain a program so that people can understand it. Good pseudocode respects program structures, but uses common words.

In WeDo 2.0, pseudocode can also be used to describe each step of a sequence. There are no specific rules to follow when writing pseudocode, but you will see that using a consistent structure will help you and your students while using it.

Example One

1. Start program
2. Start motor at power 1
3. Wait for 1 second
4. Stop motor



Example Two

1. Start program when "A" is pressed
2. Wait for Tilt Sensor to detect Shake
3. Start motor this way
4. Repeat steps 2 and 3 forever



Example Three

1. Start program when "A" is pressed
2. Wait for Tilt Sensor to detect No Tilt
3. Stop motor
4. Turn LED on color 9 (red)
5. Repeat steps 2 and 4 forever





Description of Flow Blocks

1



Start Block

When used, always placed at the beginning of a program string. Press on it to start the program string you have written.

Pseudocode: Start program

3



Send Message

Sends a message to the Programming Canvas. Every Start On Message Block with the same message will be activated. The message can be in the form of text or numbers.

Pseudocode: Send message "abc"

2



Start On Message Block

Always placed at the beginning of a program string. It will wait for the correct message and then start the program string you have written.

Pseudocode: Start program when receiving message "abc"

4



Wait For

Use this block to tell the program to wait for something to happen. It can wait for a set amount of time or for input from a sensor. This block always requires input in order to work properly.

Pseudocode: Wait for ...



5

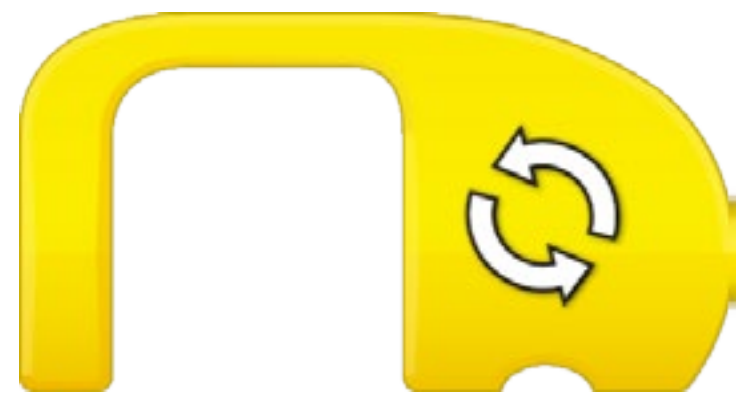

Repeat Block

Use this block to repeat actions. Blocks placed inside the Repeat Block will be looped. This can also be called the “loop block.” The loop can be repeated forever, for a certain amount of time, or until something happens.

Pseudocode: Repeat step ... forever

6



Start On Key Press Block

When used, always placed at the beginning of a program string. Press on it, or on the correct letter on the keyboard to start the program string you have written. All of the program strings with the same letter will start at the same time. To change the letter of activation, long press on the block to get access to the keyboard.

Pseudocode: Start program on tap “A”



Description of Output Motor Blocks

1



Motor This Way Block

Sets the motor to turn the axle clockwise and starts the motor. Tap on the block to quickly change the direction of the rotation.

Pseudocode: Start motor this way

3



Motor Power Block

Sets the motor power to the specified level and starts the motor. The level can be set with a numeric input from 0 to 10.

Pseudocode: Start motor at power 10

2



Motor That Way Block

Sets the motor to turn the axle counterclockwise and starts the motor. Tap on the block to quickly change the direction of the rotation.

Pseudocode: Start motor that way

4

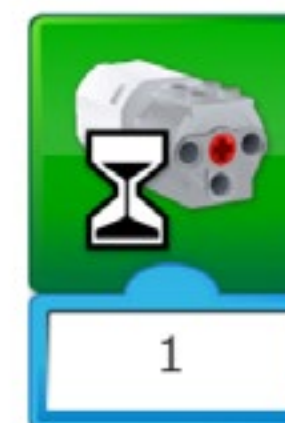

Motor On For Block

Starts the motor for a chosen amount of time specified in seconds. The amount of time can be set with a numeric input, using whole or decimal numbers.

Pseudocode: Start motor for 2 seconds



5



Motor Off Block

Stops any movement of the motor.

Pseudocode: Stop motor



Description of Light and Sound Blocks

1



Light Block

Lights up the LED on the Smarthub in a specific color. The color can be changed with a numeric input between 0 and 10.

Pseudocode: Turn LED on to color 9 (red)

Pseudocode: Turn LED off to color 0 (no color)

2



Play Sound

Plays a sound. The sound is chosen from a list available within the software. You can choose a sound using a numeric input. Choose sound number 0 to play a sound that you have recorded yourself.

Pseudocode: Play sound number 1



Description of Output Display Blocks

1



Display Background

Use this block to display an image chosen from a list available within the software. You can set an image using a numeric input.

Pseudocode: Show image 1 on display

3



Add to Display

Adds a quantity to the number currently shown on the display. Enter the number you wish to add. Tap on the block to change the mathematical operation.

Pseudocode: Add ... to the number on display

2



Display Block

Use this block to open the display area on the software screen. Numbers or text will appear in the display area.

Pseudocode: Show ... on display

4



Subtract from Display

Subtracts a quantity from the number shown on the display. Enter the number you wish to subtract. Tap on the block to change the mathematical operation.

Pseudocode: Subtract ... from the number on display



5



Multiply Display

Multiplies the number shown on the display by a specified number. Enter the number you wish to multiply by. Tap on the block to change the mathematical operation.

Pseudocode: Multiply by ... the number on display

7



Display Closed

Use this block to close the display area on the software screen. Tap on the block to change the size.

Pseudocode: Close the display

6



Divide Display

Divides the number shown on the display by another number. Enter the number you wish to divide by. Tap on the block to change the mathematical operation.

Pseudocode: Divide by ... the number on display

8



Display Full Size

Use this block to set the display area to full size. Tap on the block to change the size.

Pseudocode: Change the size of the display to maximum



Description of Output Display Blocks

1



Display Medium Size

Use this block to set the display area to medium size. Tap on the block to change the size.

Pseudocode: Change the size of the display to medium



Description of Sensor Change Inputs

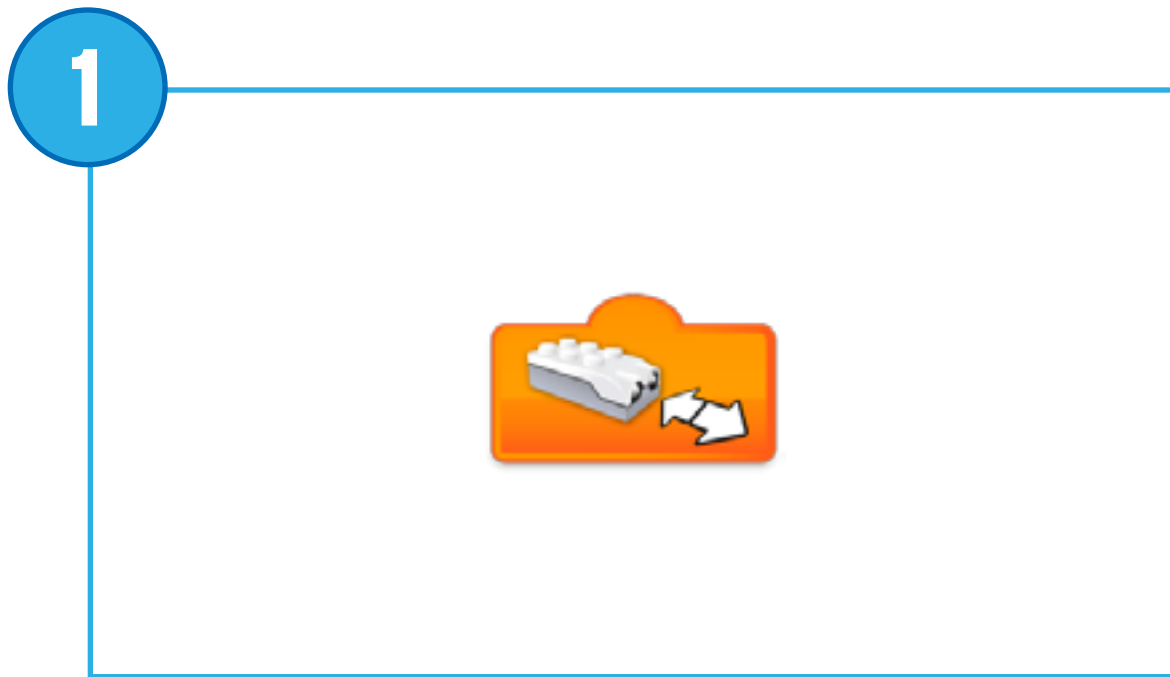

1 Any Distance Change
Inputs the Motion Sensor mode “ Any Distance Change” to a block.

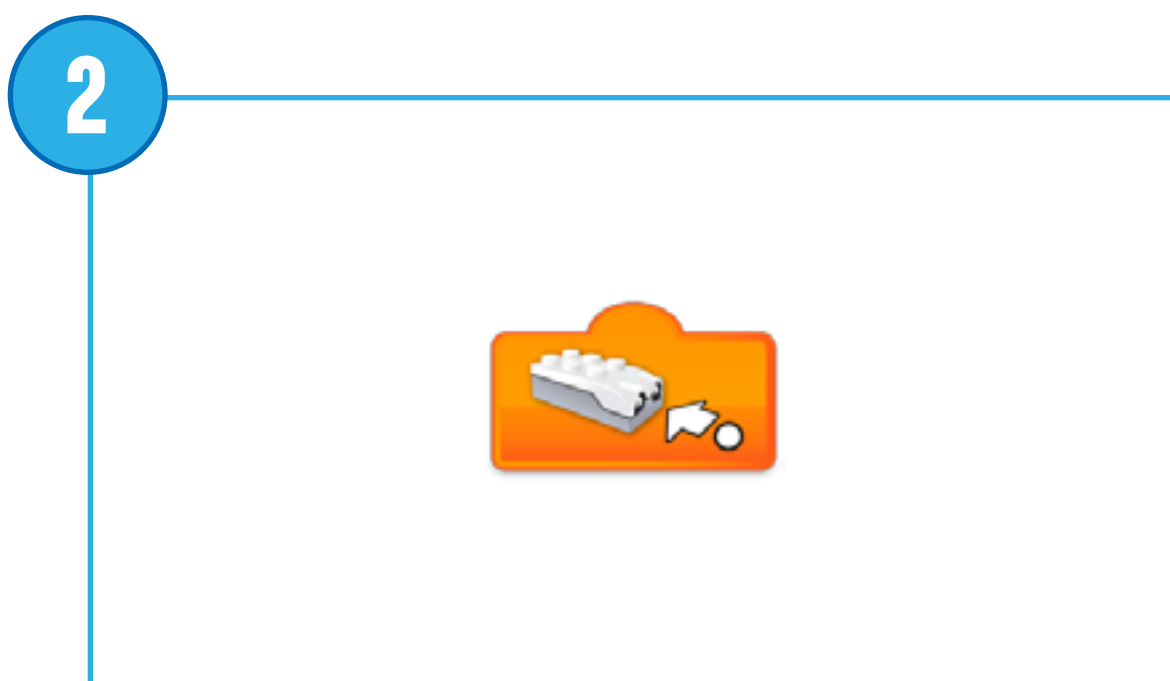

2 Distance Change Closer
Inputs the Motion Sensor mode “decreasing distance between the sensor and an object” to a block.

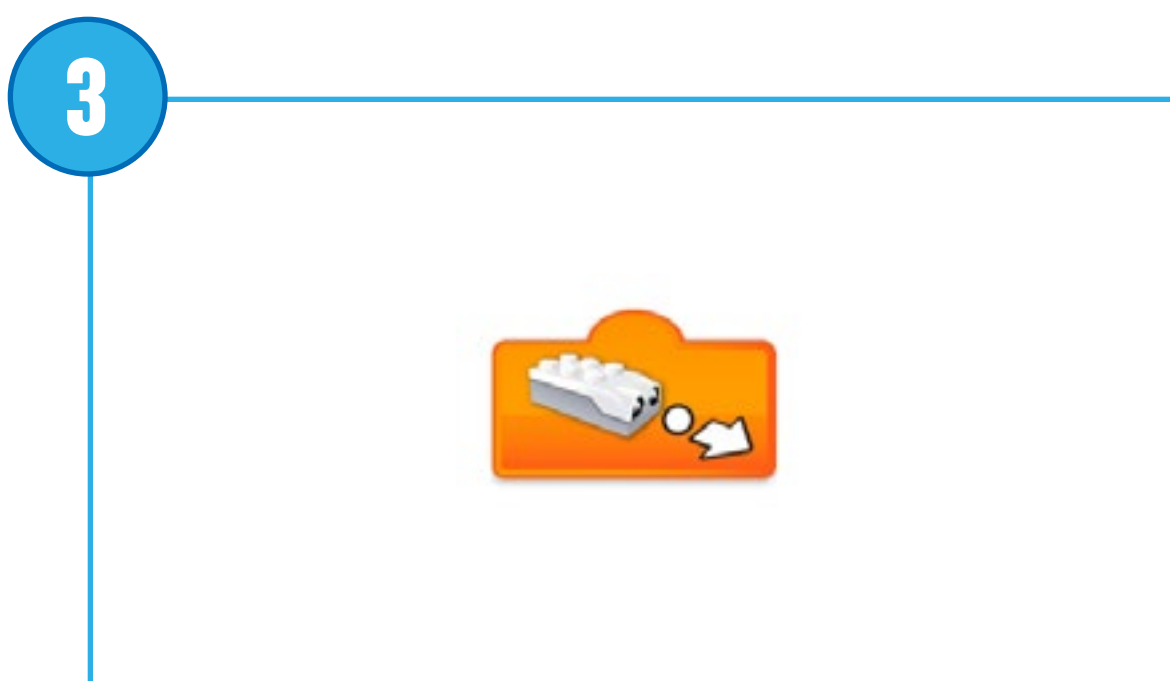

3 Distance Change Further
Inputs the Motion Sensor mode “increasing distance between the sensor and an object” to a block.

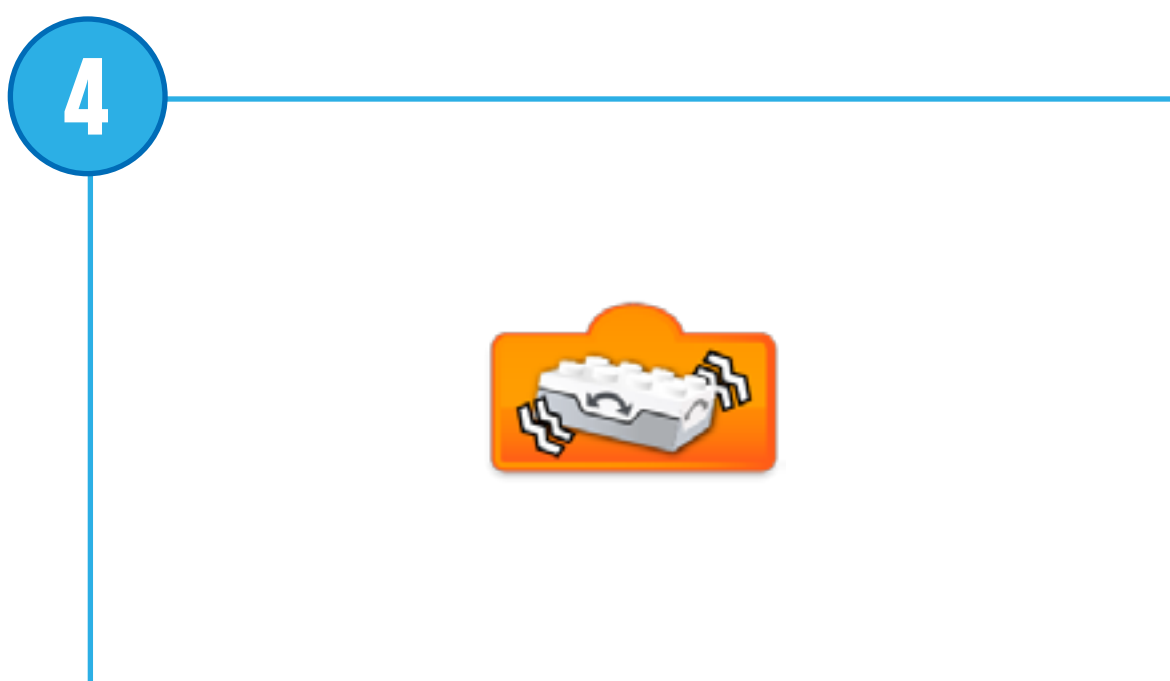

4 Shake
Inputs the Tilt Sensor mode “Shake” to a block.

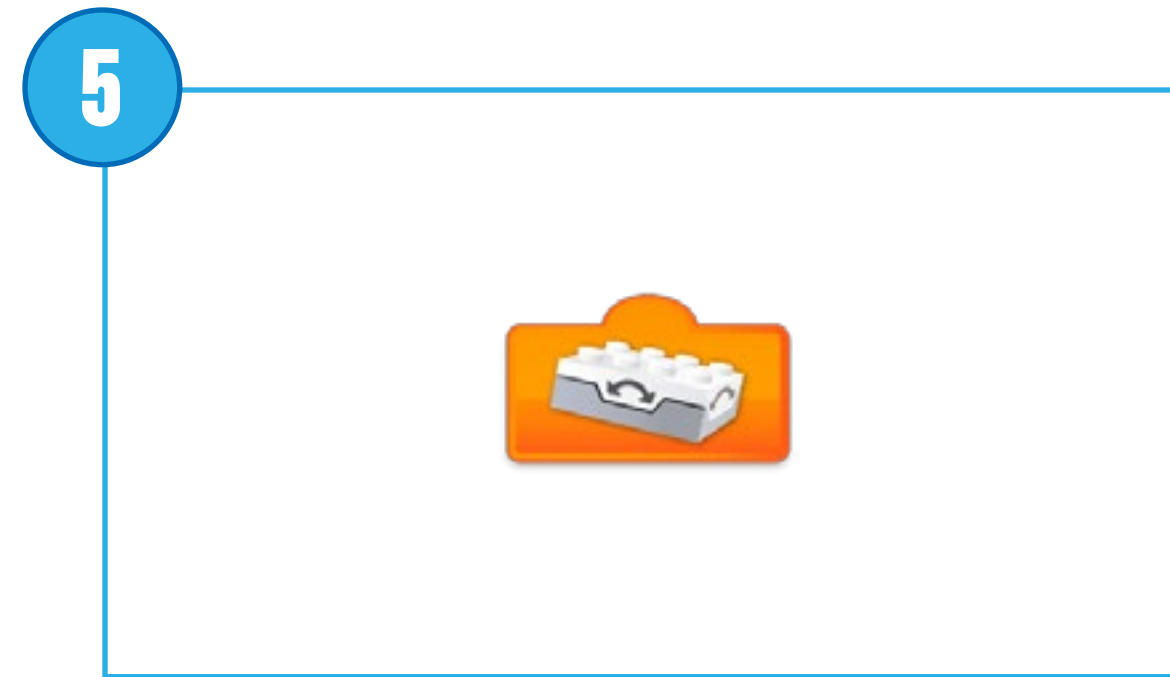

5 Tilt Down
Inputs the Tilt Sensor mode “Tilt Down” to a block.

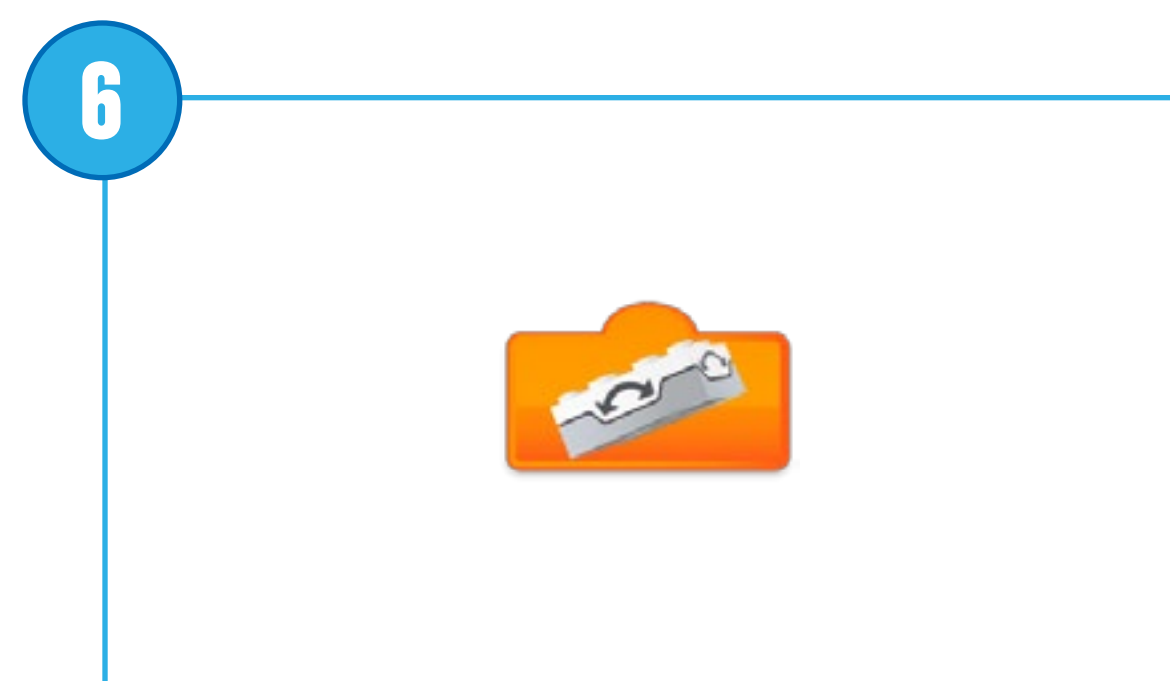

6 Tilt Up
Inputs the Tilt Sensor mode “Tilt Up” to a block.

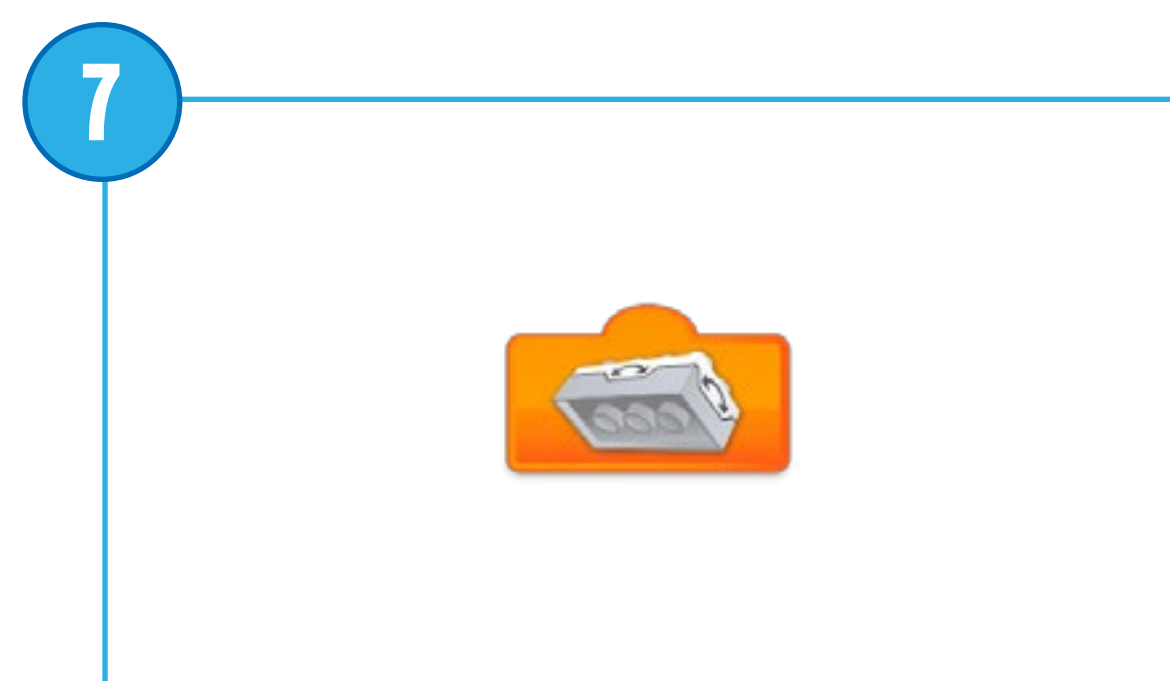

7 Tilt Left
Inputs the Tilt Sensor mode “Tilt Left” to a block.

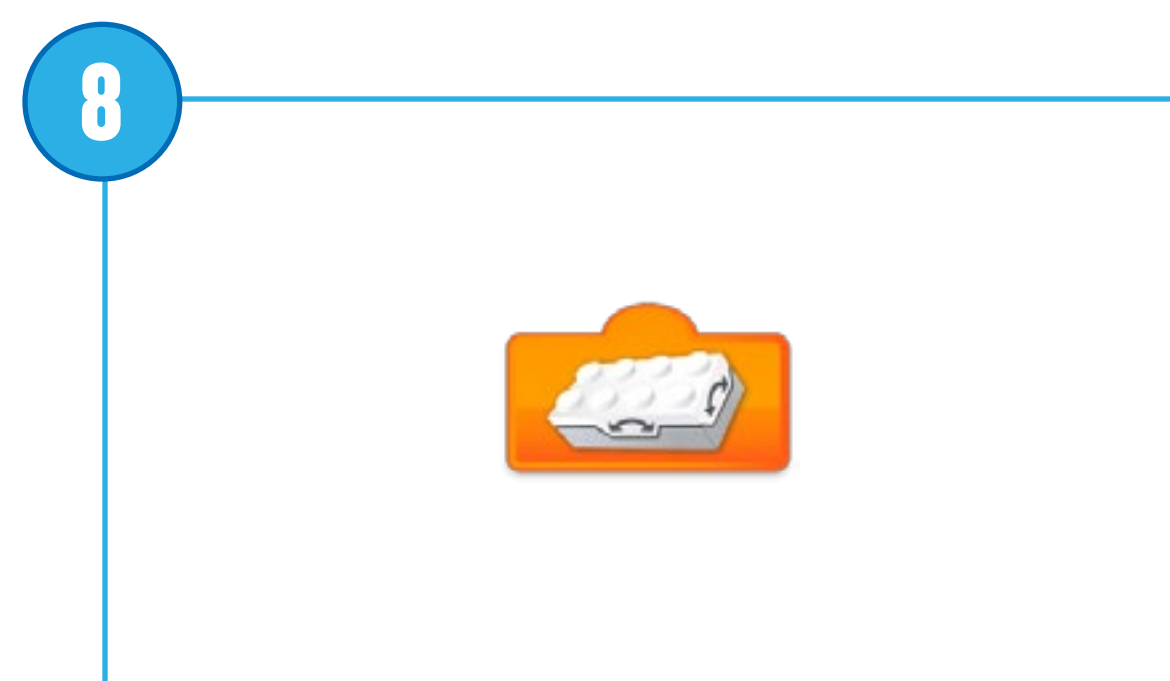

8 Tilt Right
Inputs the Tilt Sensor mode “Tilt Right” to a block.



Description of Sensor Change Inputs

1



Tilt Sensor No Tilt

Inputs the Tilt Sensor mode “No Tilt” (or horizontal position) to a block.

2



Sound Sensor Change

Inputs the Sound Sensor (from the device) mode “sound level change” to a block.



Description of Numeric and Text Inputs

1

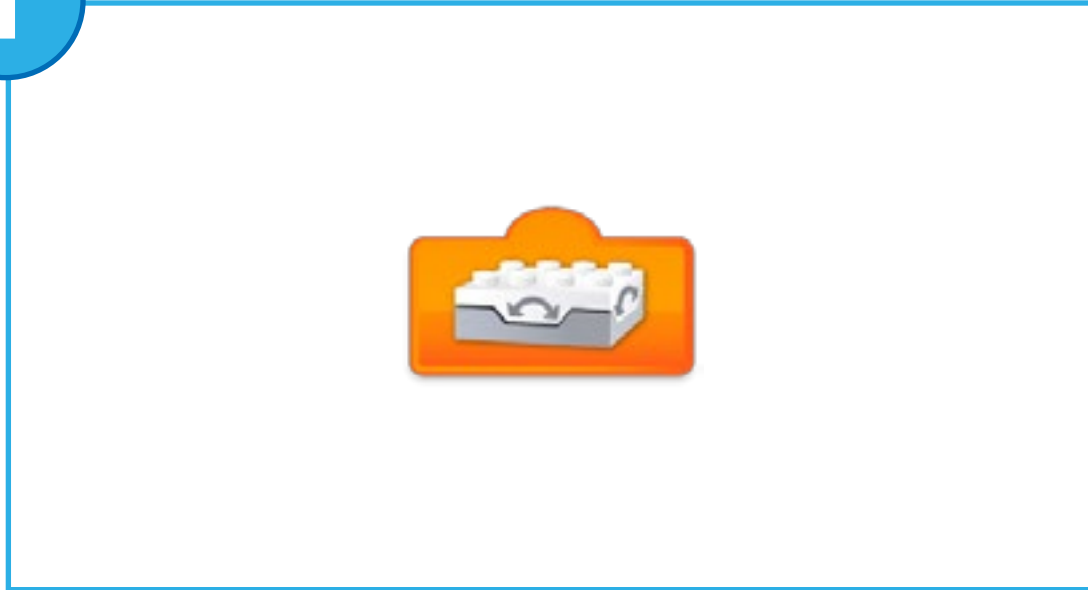

Tilt Sensor Input

Inputs the numeric value generated by the Tilt Sensor (0, 3, 5, 7, or 9) to a block.

2

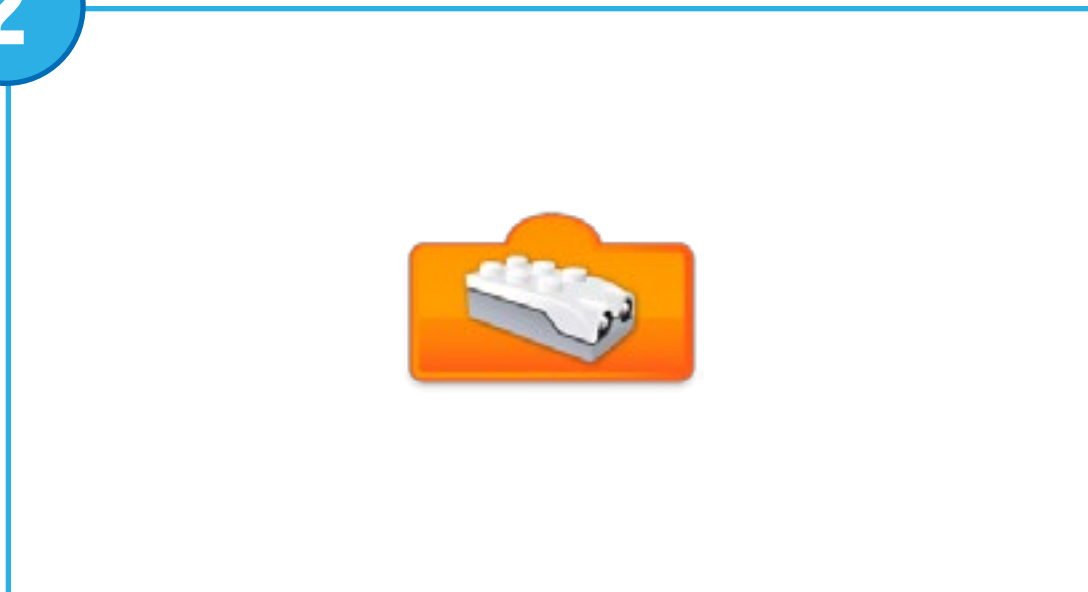

Distance Sensor Input

Inputs the value detected by the Motion Sensor (from 0 to 10) to a block.

3

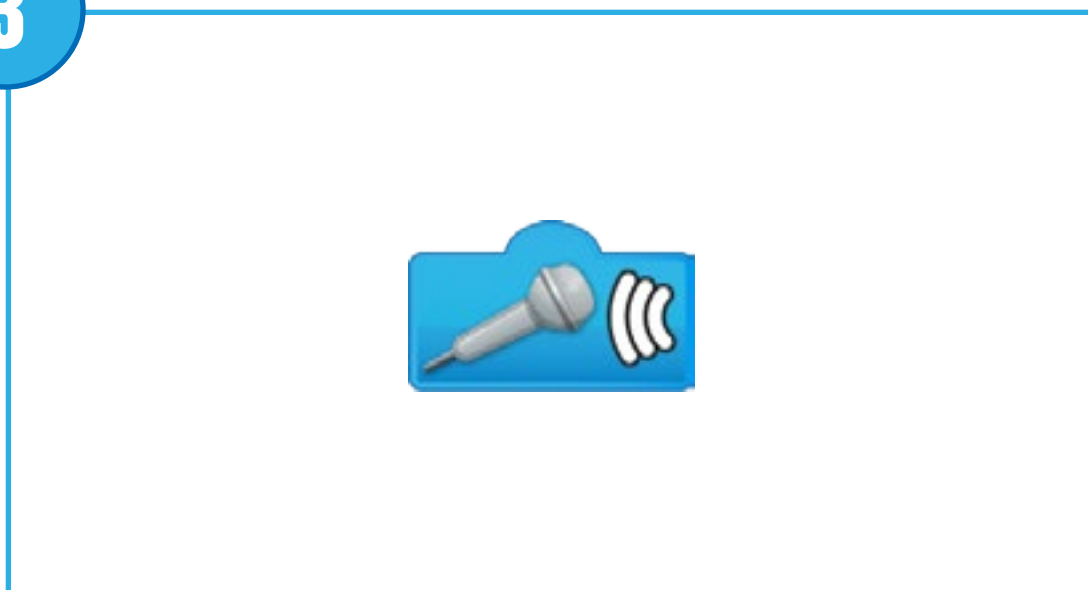

Sound Sensor Input

Inputs the value detected by the Sound Sensor (from 0 to 10) to a block.

4

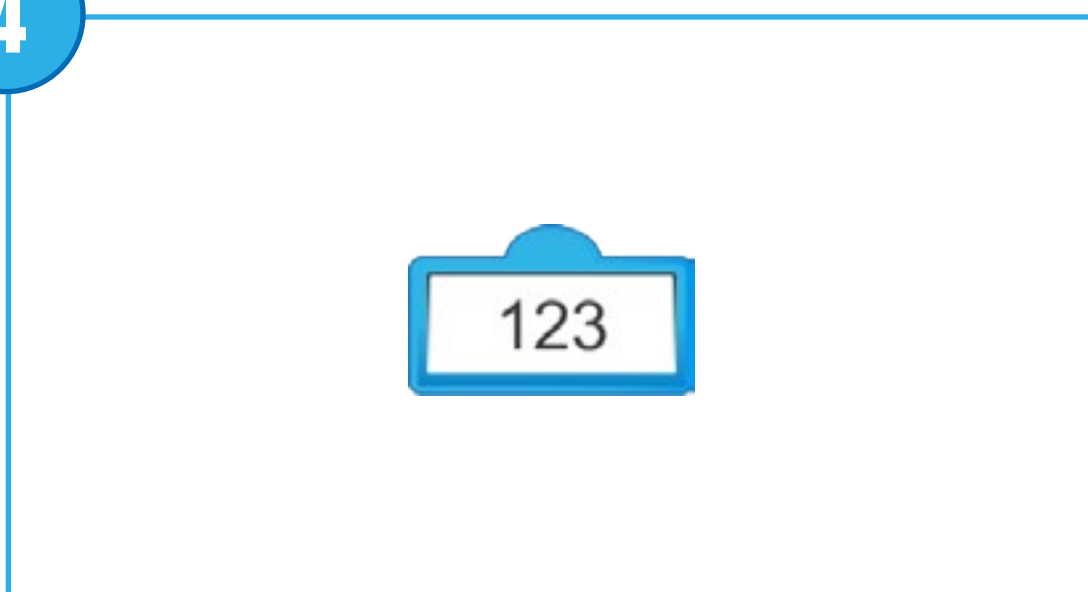

Number Input

Inputs a numeric value to a block.

5

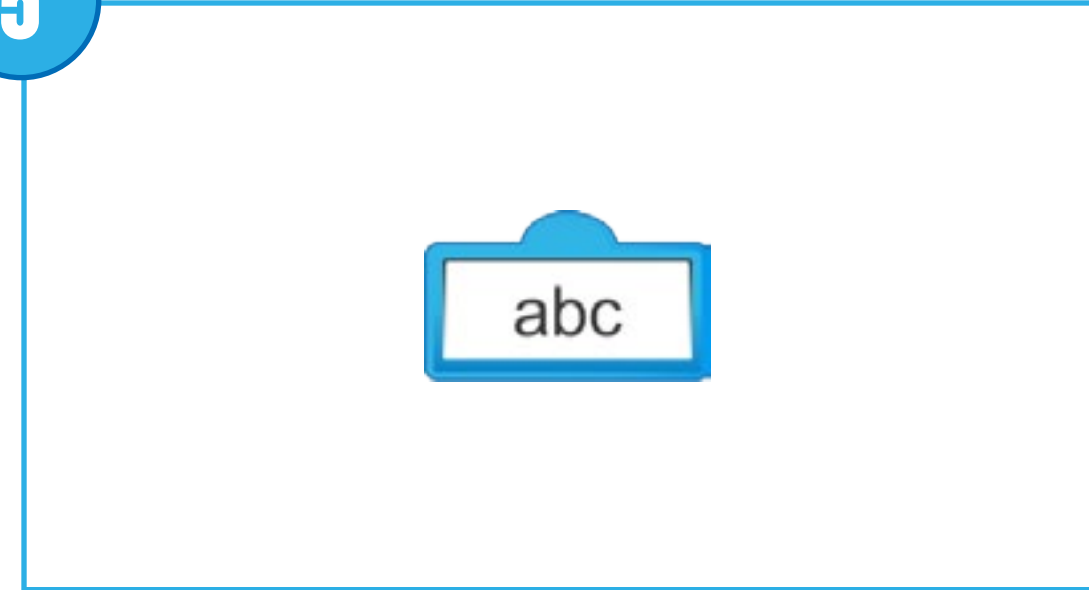

Text Input

Inputs a text value to a block.

6

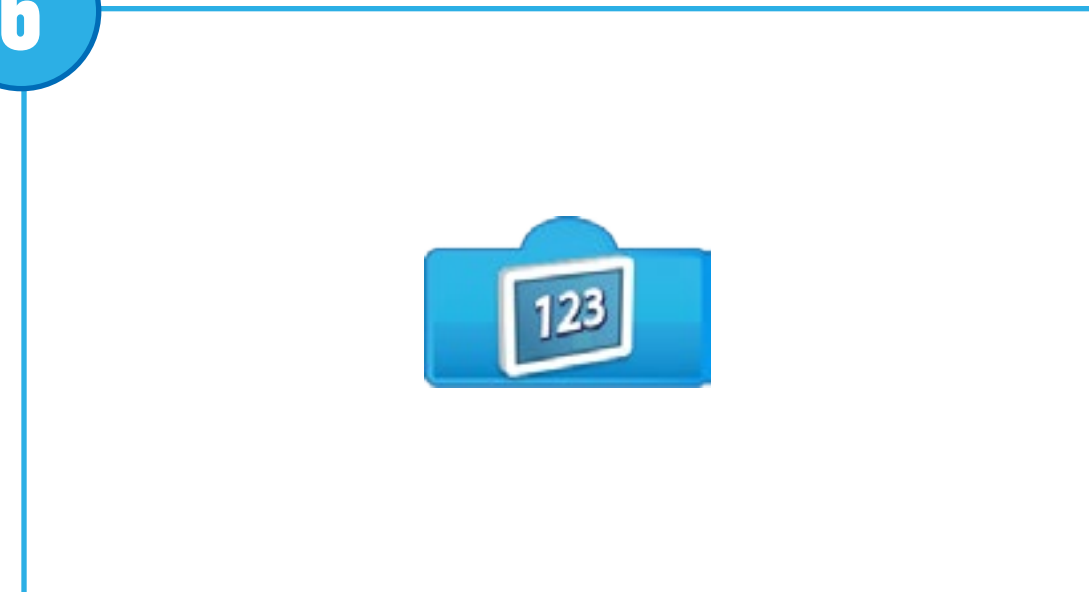

Display Input

Inputs the numeric value shown on the display area to a block.

7

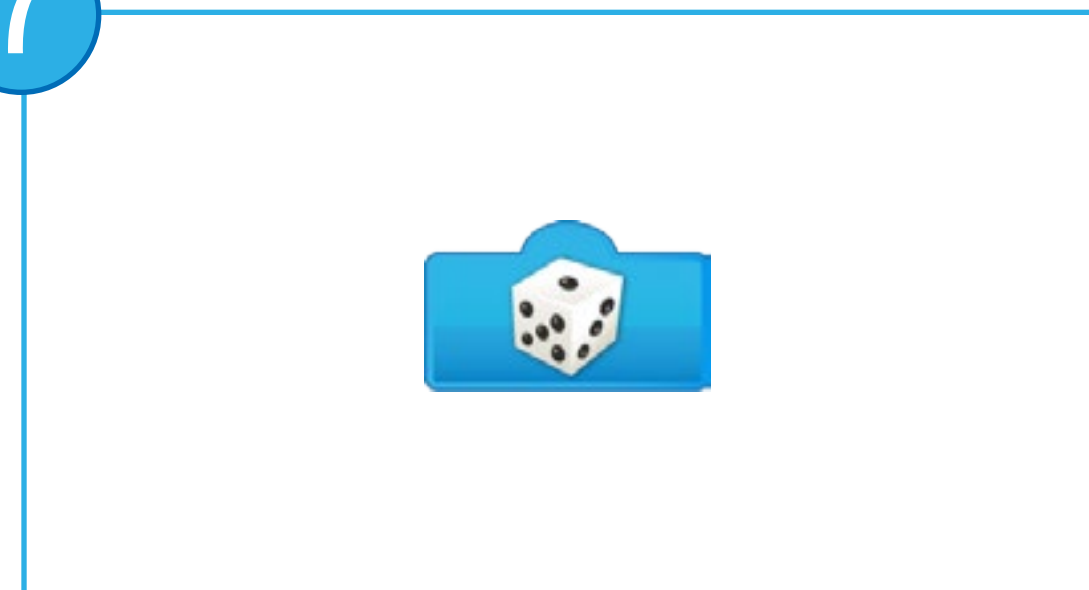

Random Input

Inputs a random value to a block. The range of numbers is determined by the block to which it is attached.



Description of the Documenting Block

1



Bubble

Use the bubble to insert comments into your program. This is not a programming block.



Planning Your Work with Flowcharts

Flowcharts are an excellent tool for practicing Abstraction, and they can be a great way to help students plan and structure their solutions.

A simple flowchart can be explored by students at any grade level, but more complex charts should be reserved for students in the higher elementary grades.

Some conventions exist in regard to flowcharts, but you should focus on implementing these conventions only when your students completely understand the concept of mapping their ideas.

These conventions are:

- Use a circle (or oval) to represent the beginning and end of the flow
- Use arrows to indicate the flow direction
- Use a rectangle to indicate an input or output
- Use a diamond to indicate conditions

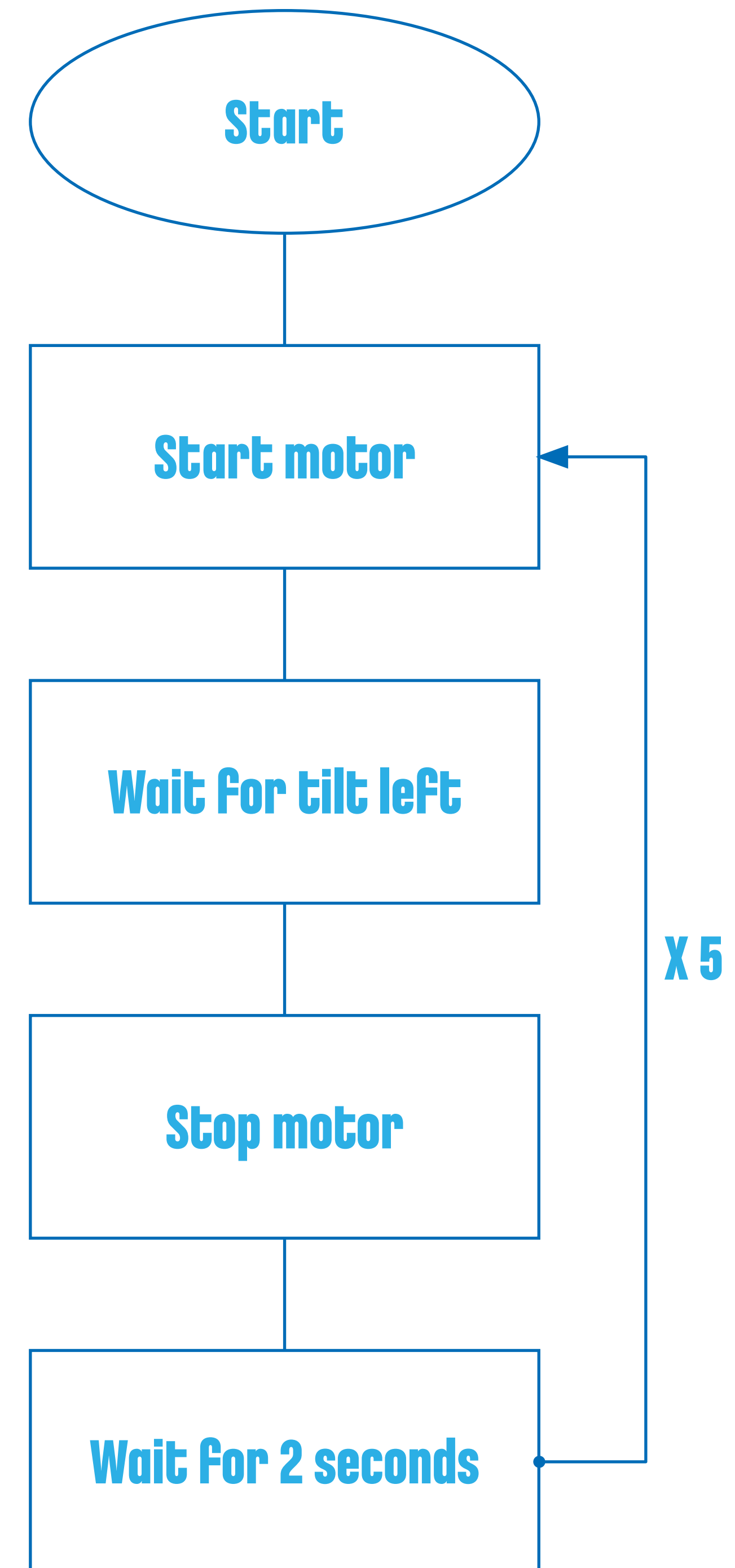

Build with WeDo 2.0

WeDo 2.0 has been designed to provide opportunities for students to sketch, build, and test prototypes and representations of objects, animals, and vehicles that have a real-world focus.

The hands-on approach encourages students to be fully engaged in the designing and building process.





Designing Solutions with LEGO® Bricks

The WeDo 2.0 projects will take you and your students on a journey of using mechanisms to bring models to life. These mechanisms have been ordered by function in the Design Library.

These instructions are provided to inspire your students as they look for solutions. All of these functions use what are called “simple machines” that you can explore with your students as they develop their ideas.





Base Models Exploration

Name of the Part: Gear

A gear is a toothed wheel that rotates and makes another part move. You can find gear wheels on your bike, they are linked together with a chain. A “gear train” is when gears are placed directly alongside each other.

Types of Gear Trains

Gear up: a large gear drives a small gear in order to produce more rotations.

Gear down: a small gear drives a larger gear in order to produce fewer rotations.

For example, used in these Design Library base models:

Walk, Spin, Turn



Name of the Part: Bevel Gear

A bevel gear is an angled gear that can be placed perpendicular to another gear, changing the axis of the rotation.

For example, used in these Design Library base models:

Flex, Wobble, Push, Turn

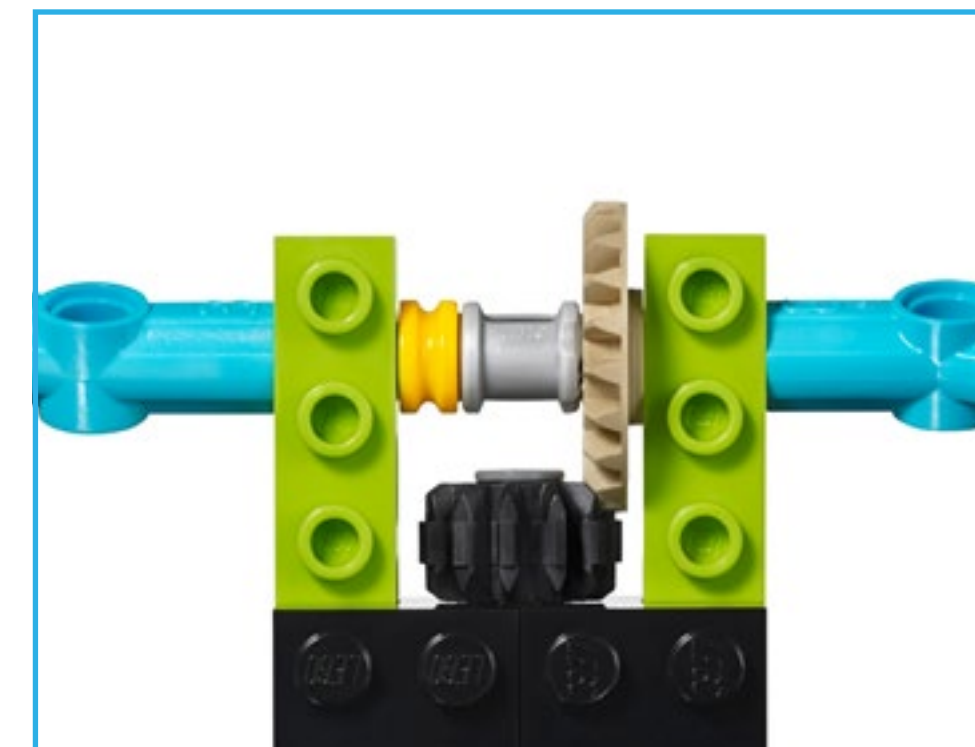



Base Models Exploration

Name of the Part: Rack

A rack is a flat element with teeth that engages a circular gear, in this case often called a pinion. This pair of gears change ordinary rotational motion, as the gear turns into linear motion.

For example, used in these Design Library base models:

Push



Name of the Part: Worm Gear

A worm is a continual spiral groove like a screw, which meshes with a gear. The worm is designed to turn a normal gear, but the gear cannot turn the worm, therefore, it functions as a brake.

For example, used in these Design Library base models:

Revolve

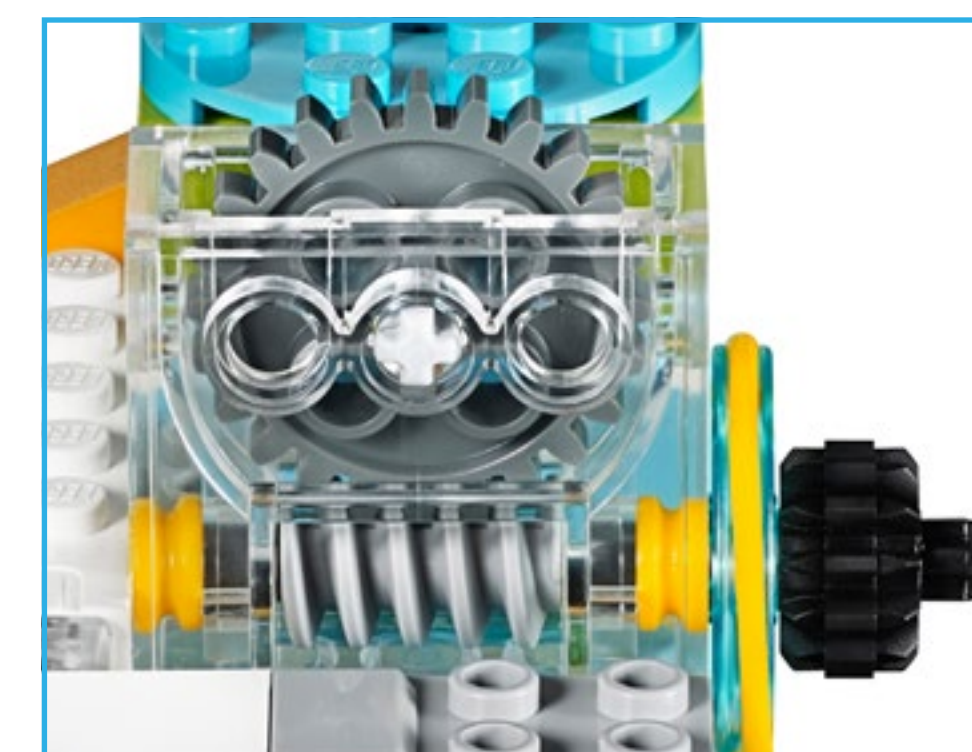



Base Models Exploration

Name of Part: Beam

A beam attached to a rotating part will become a piston. A piston is a moving component of a machine, transferring the energy created by the motor into an up/down or forward/backward motion. The piston can push, pull, or drive other mechanical elements of the same machine.

For example, used in these Design Library base models:

Crank



Name of the Part: Wheels

It's a circular element that rotates on an axis to produce propelled movement.

For example, used in these Design Library base models:

Wobble, Drive, Steer





Base Models Exploration

Name of the Part: Pulley

The pulley is a wheel with a groove in it where the belt rests. The belt is like a small rubber band, which connects to a part of the model that is rotating, transferring the rotation to a different part of the model.

Pulley up: a large pulley drives a small pulley to produce more rotations.

Pulley down: a small pulley drives a large pulley to produce less rotations.

Pulley twist: it is used to make shafts that are parallel but rotate in opposite directions.

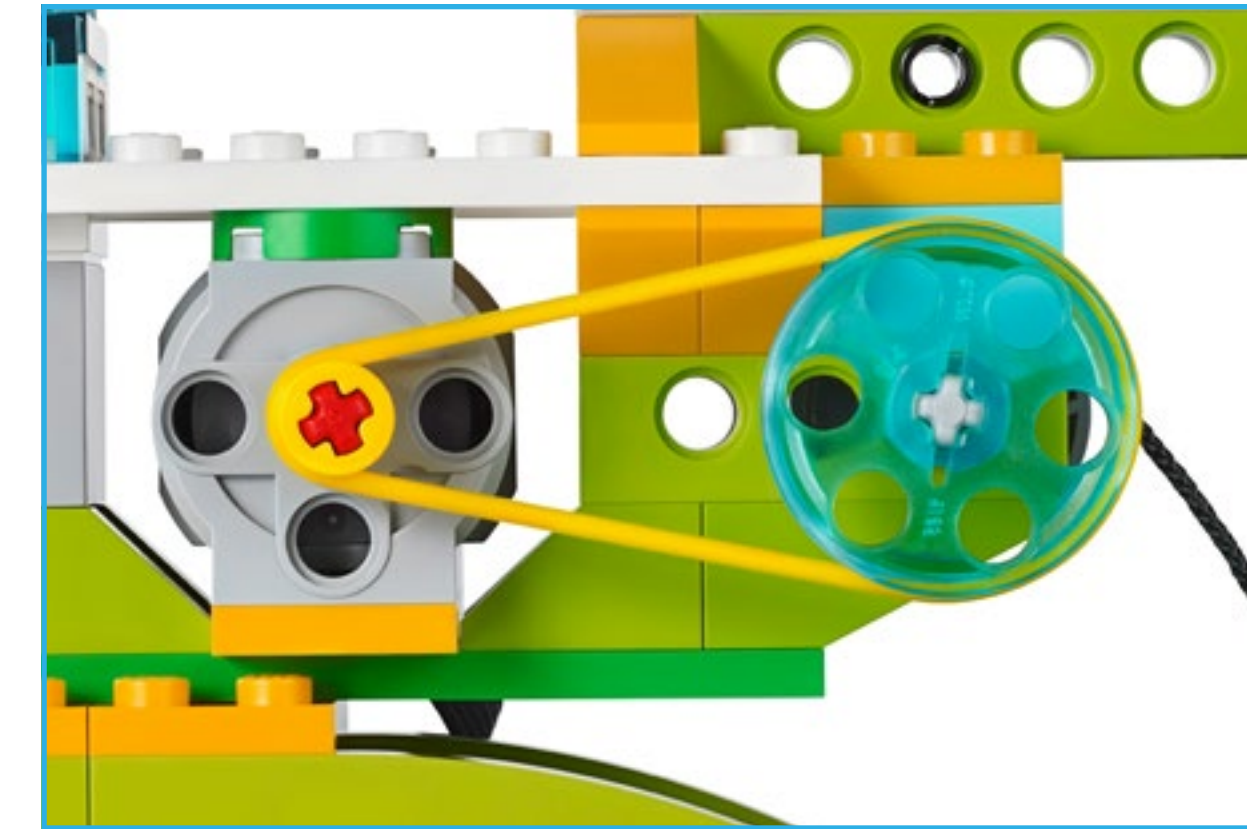

For example, used in these Design Library base models:

Reel, Lift, Drive, Sweep, Revolve, Grab

▶ Important

Using a pulley in a mechanism will prevent the model from breaking when it meets resistance as the belt will slip in the pulley.

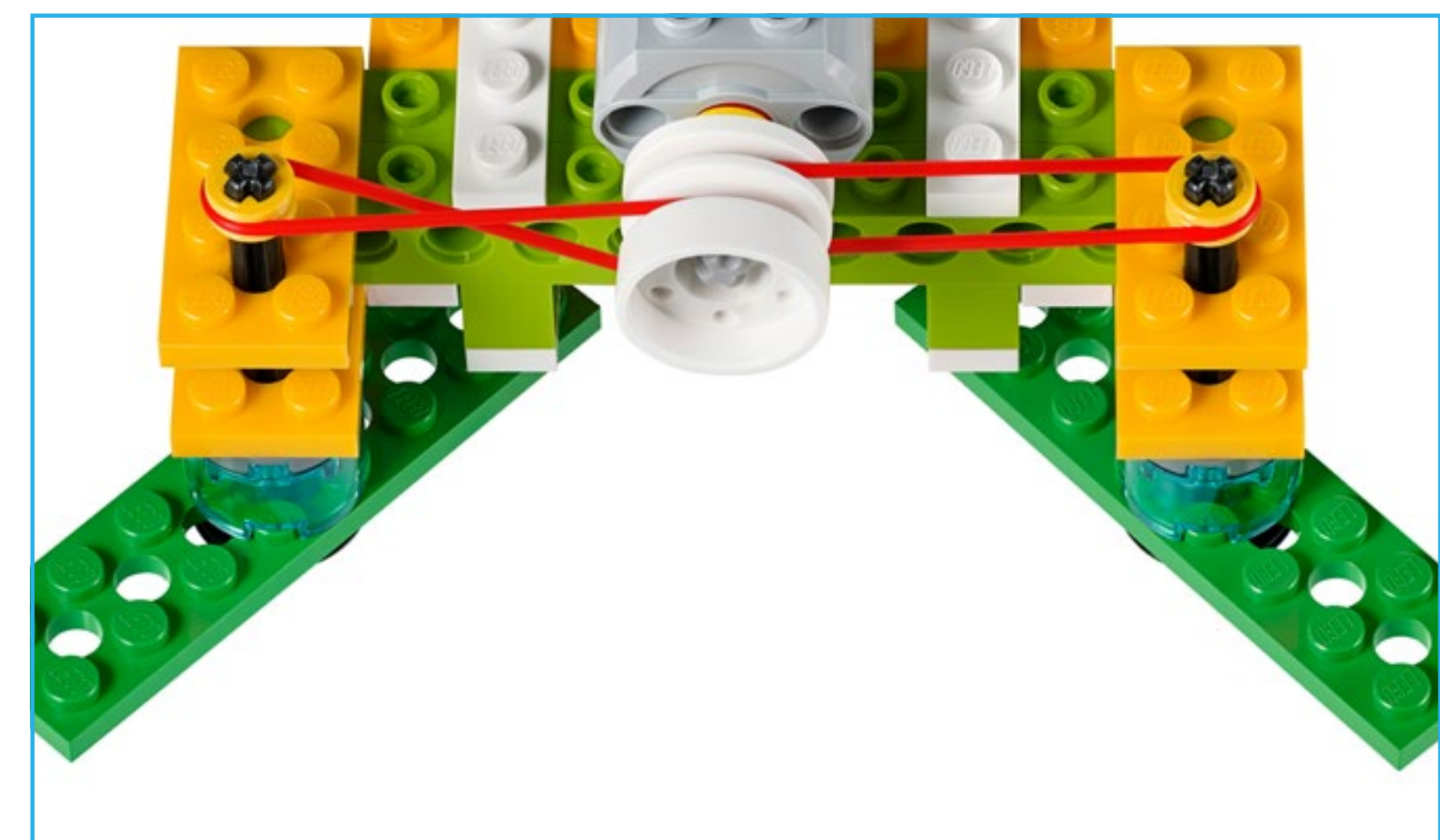



Electronic Parts

Smarthub

The Smarthub acts as a wireless connector among your device and the other electronic parts, using Bluetooth Low Energy. It receives program strings from the device and executes them.

The Smarthub has important features:

- Two ports to connect sensors or motors
- One LED
- Power button

The Smarthub uses AA batteries or the supplementary Rechargeable Battery as a power source.

The Bluetooth connection procedure between the Smarthub and your device is explained in the WeDo 2.0 Software.

The Smarthub will use color patterns to signal messages:

- Flashing white light: it is waiting for a Bluetooth connection.
- Blue light: a Bluetooth connection is established.
- Flashing orange light: the power provided to the motor is at its limit.





Electronic Parts

Smarthub Rechargeable Battery (Supplementary Item)

Here are some guidelines for the Smarthub Rechargeable Battery:

- To have optimal hours of play without the adaptor connected, fully charge the battery first.
- There is no special demand for a charging pattern.
- Preferably, store the battery in a cool place.
- If the battery is installed in the Smarthub and not used from one to two months, recharge it again after this period.
- Do not let the battery charge for an extended period of time.



Medium Motor

A motor is what makes other things move. This Medium Motor uses electricity to make an axle rotate.

The motor can be started in both directions, can be stopped, and can turn at different speeds and for a specific amount of time (specified in seconds).





Electronic Parts: Sensors

Tilt Sensor

To interact with this sensor, tilt the part in different ways following the arrows.

This sensor detects changes within six different positions:

- Tilt This Way
- Tilt That Way
- Tilt Up
- Tilt Down
- No Tilt
- Shake

Make sure you have the correct icon in your program that corresponds to the position you are trying to detect.



Motion Sensor

This sensor detects changes in distance from an object within its range in three different ways:

- Object moving closer
- Object moving farther away
- Object changing position

Make sure you have the correct icon in your program that corresponds to the position you are trying to detect.





Part Names and Primary Functions

As students use the bricks, you may want to discuss proper vocabulary as well as functions for each part in the set.

- Some of them are structural parts that hold your model together.
- Some parts are connectors that link elements to each other.
- Some parts are used to produce movement.

▶ Important

Remember that these categories are guidelines. Some parts have many functions and can be used in many ways.

▶ Suggestion

Use the cardboard box to help you sort the parts in the WeDo 2.0 storage box. This will help you and your students view and count the parts.

©2016 The LEGO Group. 6145262

45300



Structural Parts



2x - Angular plate, 1x2/2x2, white. No.6117940

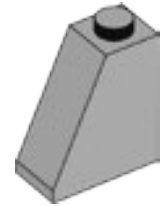

4x - Roof brick, 1x2x2, gray. No.4515374



2x - Tile, 1x2, azure blue. No.4649741



4x - Roof brick, 1x2/45°, lime green. No.4537925



2x - Curved brick, 1x3, lime green. No.4537928



4x - Roof brick, 1x2x2/3, bright orange. No.6024286

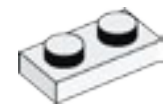

6x - Plate, 1x2, white. No.302301

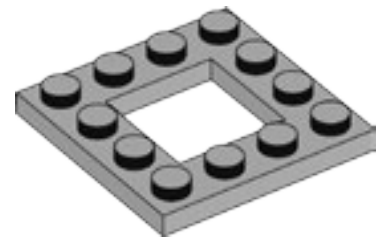

2x - Frame plate, 4x4, gray. No.4612621

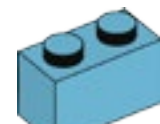

6x - Brick, 1x2, azure blue. No.6092674

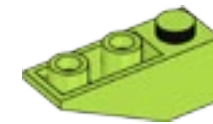

4x - Inverted roof brick, 1x3/25°, lime green. No.6138622

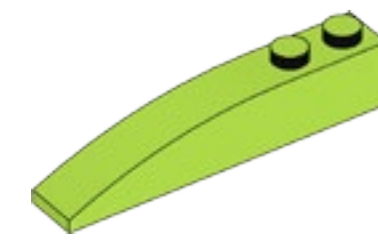

4x - Curved brick, 1x6, lime green. No.6139693



4x - Inverted roof brick, 1x2/45°, bright orange. No.6136455



4x - Plate, 1x4, white. No.371001

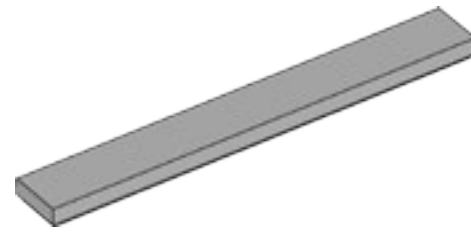

4x - Tile, 1x8, gray. No.4211481



2x - Brick, 2x2, azure blue. No.4653970

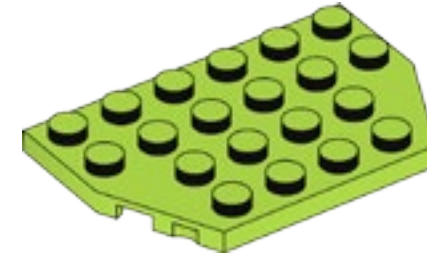

2x - Plate, 4x6/4, lime green. No.6116514

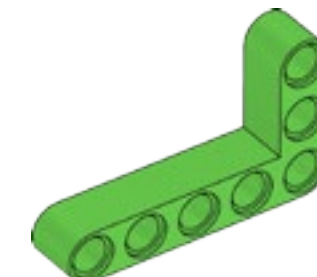

2x - Angular beam, 3x5-modules, bright green. No.6097397

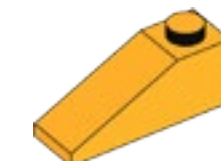

4x - Roof brick, 1x3/25°, bright orange. No.6131583



4x - Plate, 1x6, white. No.366601

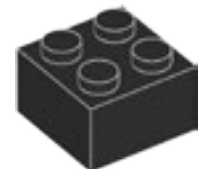

4x - Brick, 2x2, black. No.300326

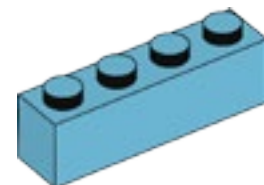

2x - Brick, 1x4, azure blue. No.6036238



4x - Studded beam, 1x2, lime green. No.6132372

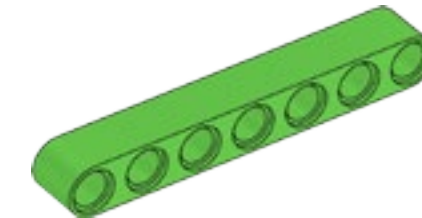

2x - Beam, 7-modules, bright green. No.6097392

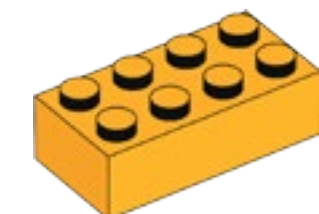

4x - Brick, 2x4, bright orange. No.6100027

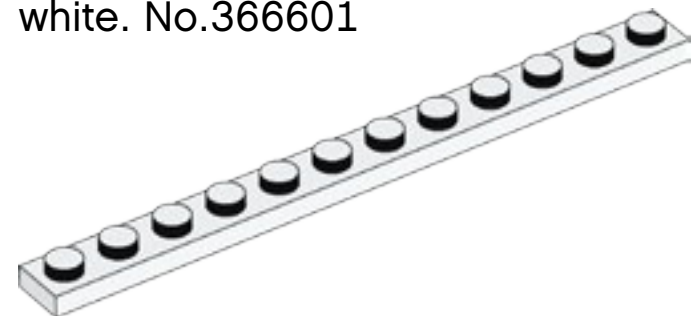

2x - Plate, 1x12, white. No.4514842

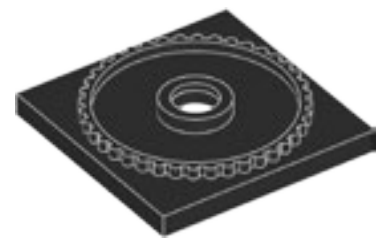

1x - Bottom for turntable, 4x4, black. No.4517986

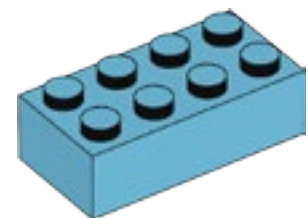

2x - Brick, 2x4, azure blue. No.4625629

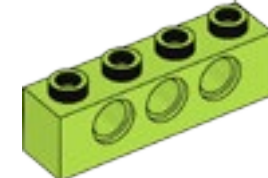

4x - Studded beam, 1x4, lime green. No.6132373

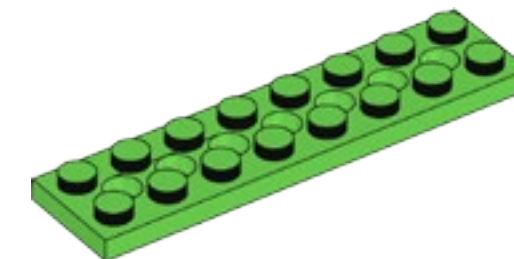

2x - Plate with holes, 2x8, bright green. No.6138494

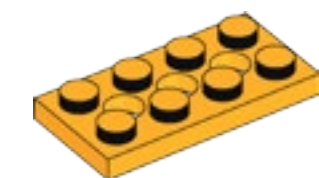

4x - Plate with holes, 2x4, bright orange. No.6132408



4x - Beam with plate, 2-modules, black. No.4144024



2x - Curved plate, 1x4x2/3, azure blue. No.6097093

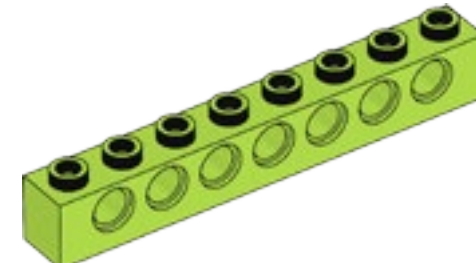

2x - Studded beam, 1x8, lime green. No.6132375

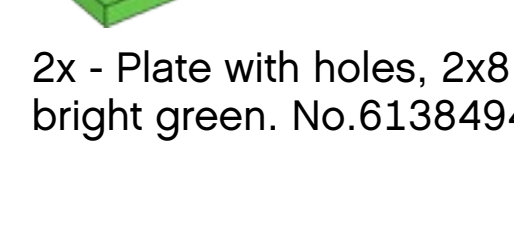

4x - Plate with holes, 2x6, bright orange. No.6132409



2x - Roof brick, 1x2/45°, black. No.4121966



2x - Round plate, 4x4, azure blue. No.6102828

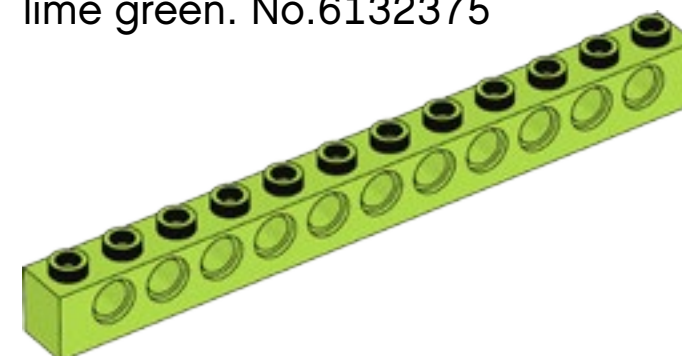

2x - Studded beam, 1x12, lime green. No.6132377

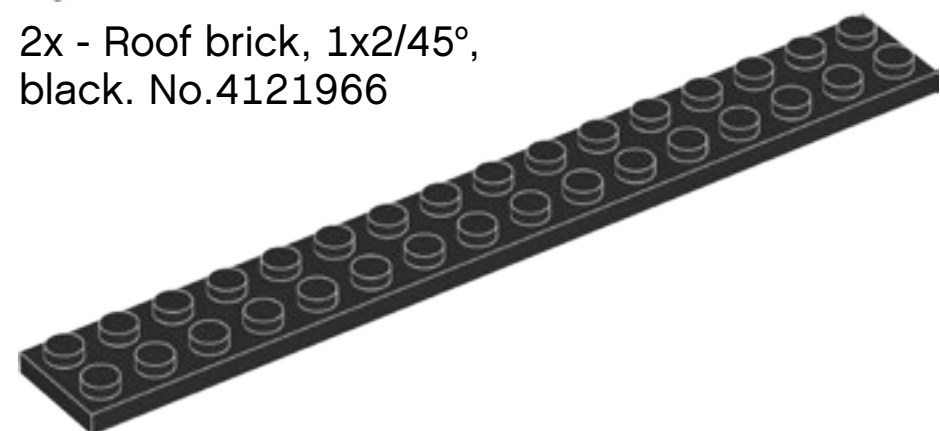

2x - Plate, 2x16, black. No.428226

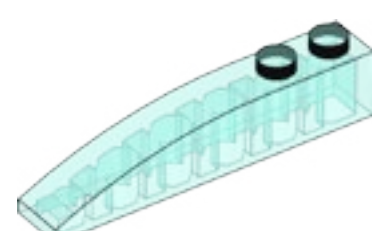

2x - Curved brick, 1x6, transparent light blue. No.6032418

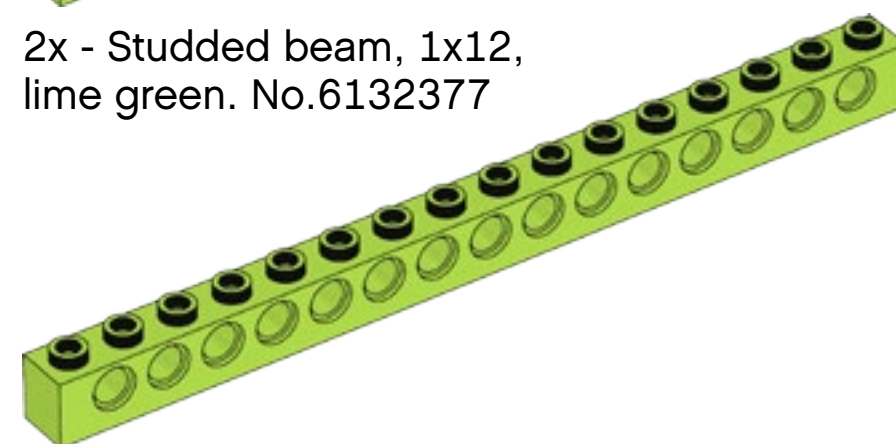

2x - Studded beam, 1x16, lime green. No.6132379

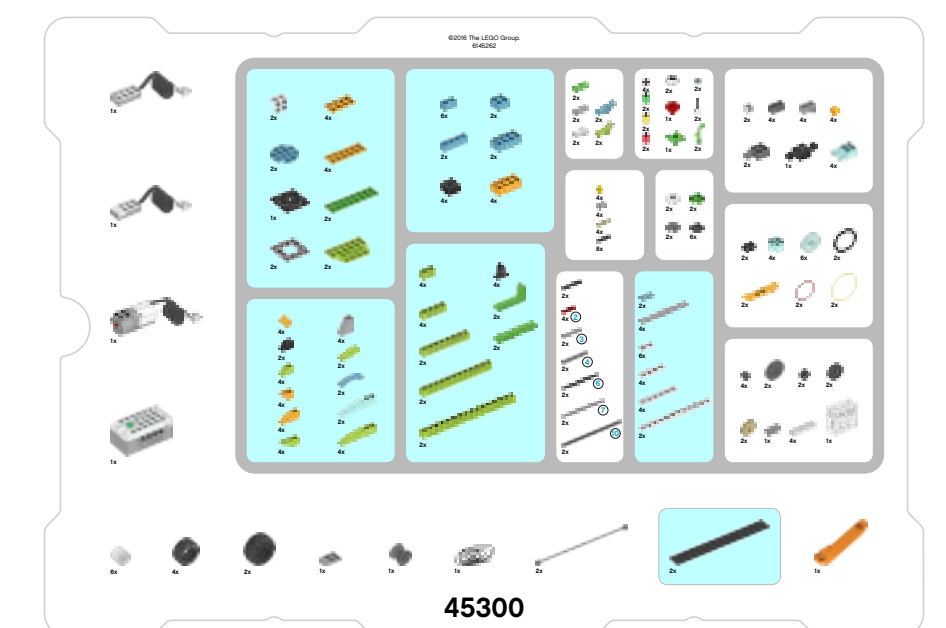



Connecting Parts



2x - Brick with stud on side, 1x1, white. No.4558952



4x - Bushing, 1-module, gray. No.4211622



8x - Connector peg, with friction, 2-modules, black. No.4121715

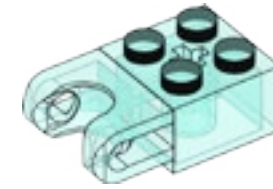

4x - Brick with ball bearing, 2x2, transparent light blue. No.6045980



2x - Angular block 4, 135°, lime green. No.6097773



4x - Connector peg, without friction/axle, 1-module/1-module, beige. No.4666579



2x - Angular block 1, 0°, white. No.4118981



2x - Bushing/axle extender, 2-module, gray. No.4512360

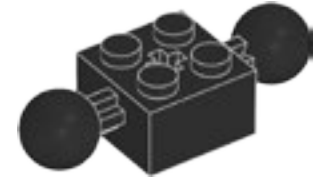

1x - Brick with 2 ball joints, 2x2, black. No.6092732

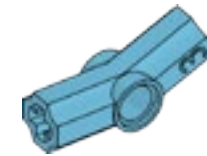

2x - Angular block 3, 157,5°, azure blue. No.6133917



2x - Tube, 2-modules, bright green. No.6097400



4x - Ball with crosshole, bright orange. No.6071608

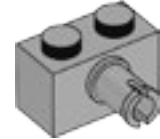

4x - Brick with connector peg, 1x2, gray. No.4211364



1x - String, 50 cm, black. No.6123991



1x - Plate with hole, 2x3, gray. No.4211419



4x - Studded beam with crosshole, 1x2, dark gray. No.4210935

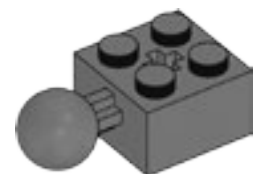

2x - Brick with 1 ball joint, 2x2, dark gray. No.4497253



1x - Bobbin, dark gray. No.4239891



2x - Chain, 16-modules, dark gray. No.4516456

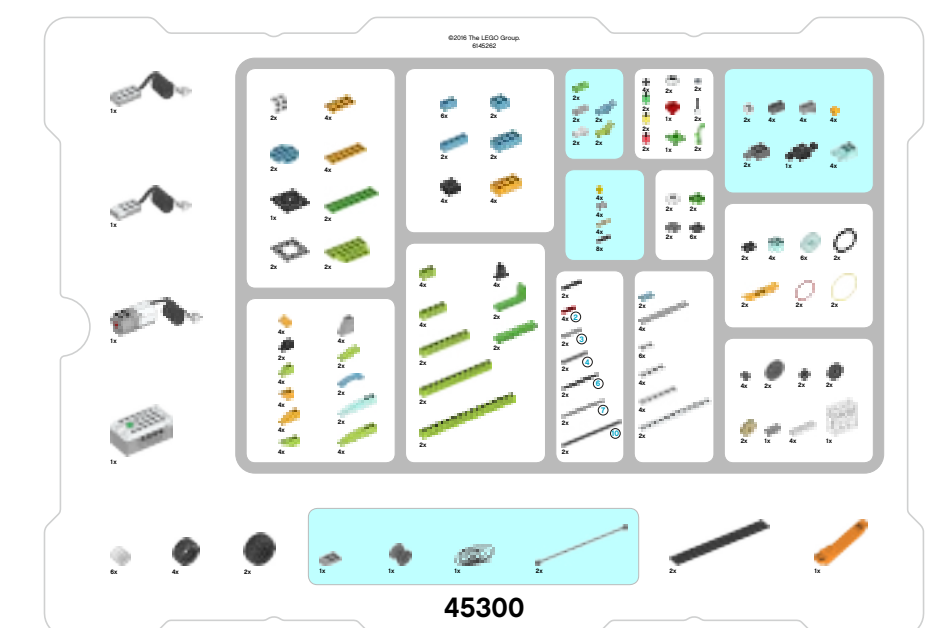



Movement Parts



6x - Hub/pulley, 18x14 mm, white. No.6092256



1x - Worm gear, gray. No.4211510



2x - Rubber beam with crossholes, 2-modules, black. No.4198367



4x - Axle, 2-modules, red. No.4142865



2x - Bevel gear, 20-tooth, beige. No.6031962

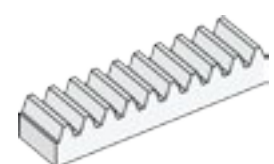

4x - Gear rack, 10-tooth, white. No.4250465



4x - Gear, 8-tooth, dark gray. No.6012451



2x - Double bevel gear, 12-tooth, black. No.4177431



2x - Connector peg with axle, 3-modules, black. No.6089119



2x - Belt, 33 mm, yellow. No.4544151

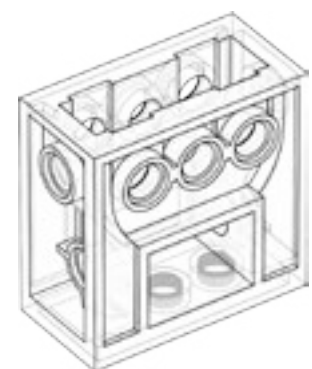

1x - Gear block, transparent. No.4142824



2x - Gear, 24-tooth, dark gray. No.6133119



2x - Double bevel gear, 20-tooth, black. No.6093977



2x - Axle, 3-modules, gray. No.4211815



2x - Snowboard, bright orange. No.6105957



2x - Tire, 30.4x4 mm, black. No.6028041



2x - Axle with stop, 4-modules, dark gray. No.6083620



2x - Belt, 24 mm, red. No.4544143



4x - Round brick, 2x2, transparent light blue. No.4178398



4x - Tire, 30.4x14 mm, black. No.4619323

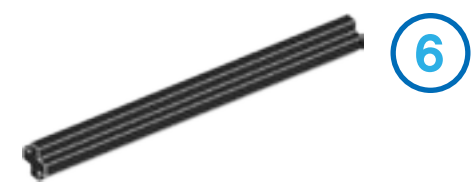

2x - Axle, 6-modules, black. No.370626

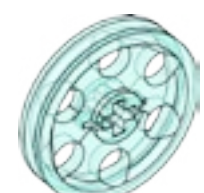

6x - Hub/pulley, 24x4 mm, transparent light blue. No.6096296



2x - Tire, 37x18 mm, black. No.4506553

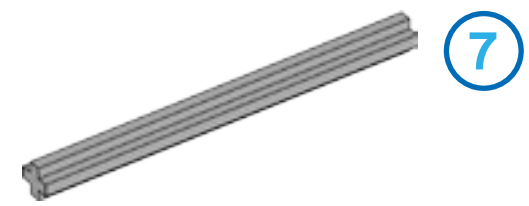

2x - Axle, 7-modules, gray. No.4211805

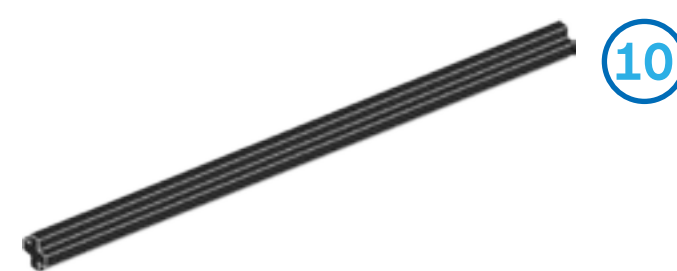

2x - Axle, 10-modules, black. No.373726

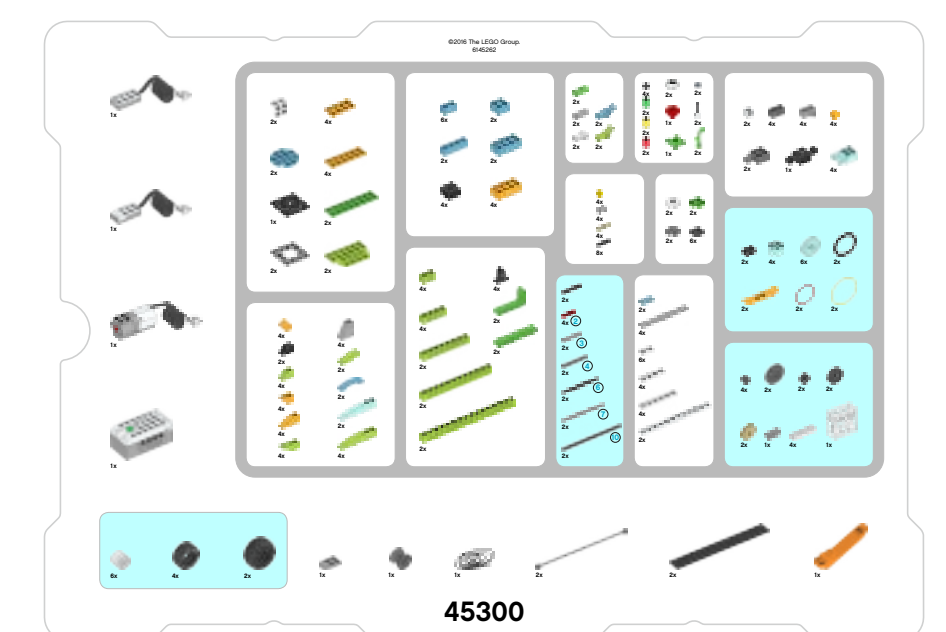



Decorative Parts



2x - Antenna, white. No.73737



2x - Round brick, 1x1, transparent green. No.3006848



2x - Round brick, 1x1, transparent yellow. No.3006844



2x - Round tile with eye, 1x1, white. No.6029156



2x - Grass, 1x1, bright green. No.6050929



2x - Round brick, 1x1, transparent red. No.3006841



2x - Round tile with eye, 2x2, white. No.6060734



2x - Round plate, 2x2, bright green. No.6138624



1x - Flower, 2x2, red. No.6000020



2x - Round plate with 1 stud, 2x2, white. No.6093053



1x - Leaves, 2x2, bright green. No.4143562

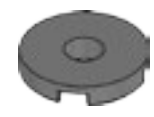

2x - Round tile with hole, 2x2, dark gray. No.6055313



4x - Round plate, 1x1, black. No.614126



6x - Skid plate, 2x2, black. No.4278359

Brick Separator

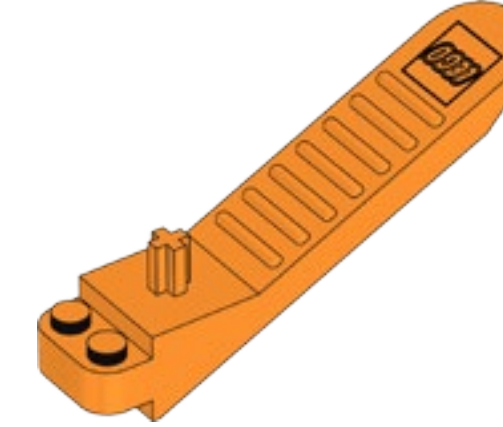

1x - Element separator, orange. No.4654448

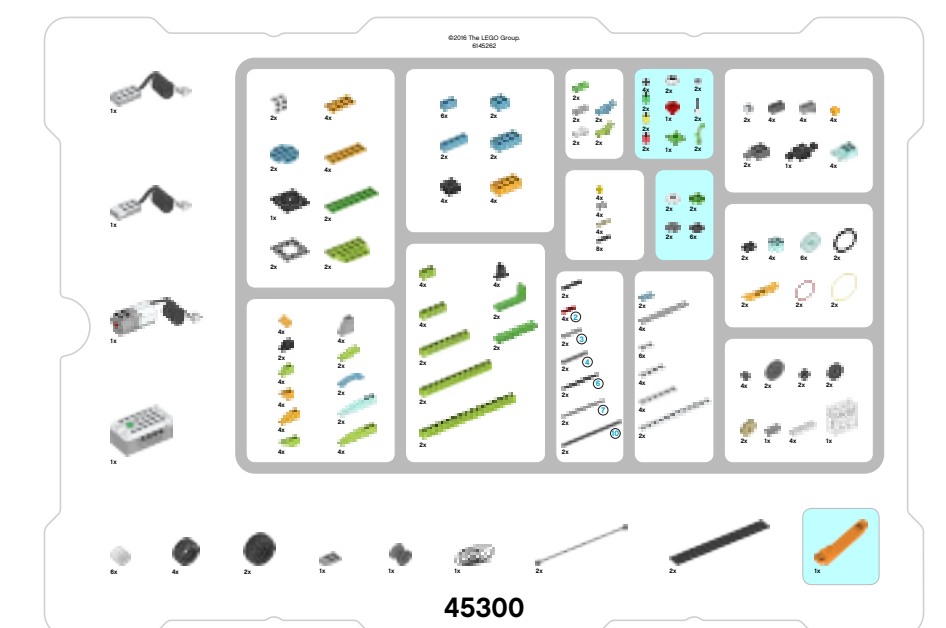

Electronic Parts



1x - Tilt Sensor,
white. No.6109223

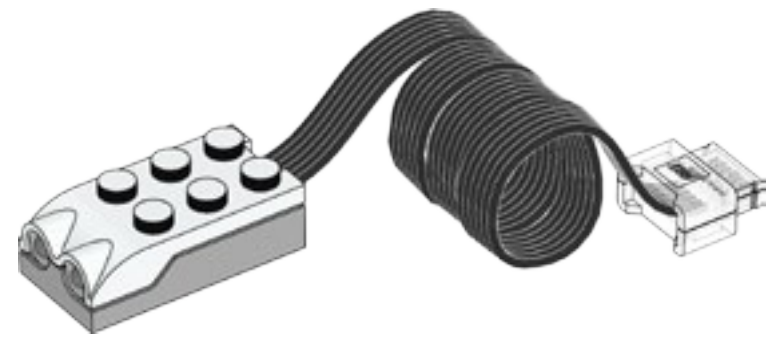

1x - Motion Sensor,
white. No.6109228

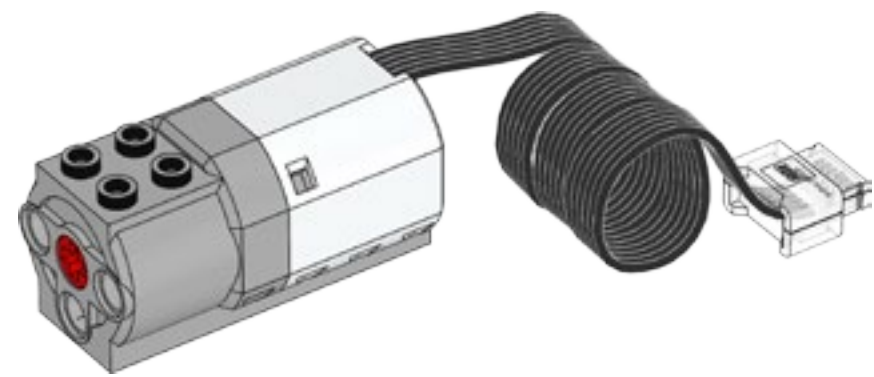

1x - Medium Motor,
white. No.6127110

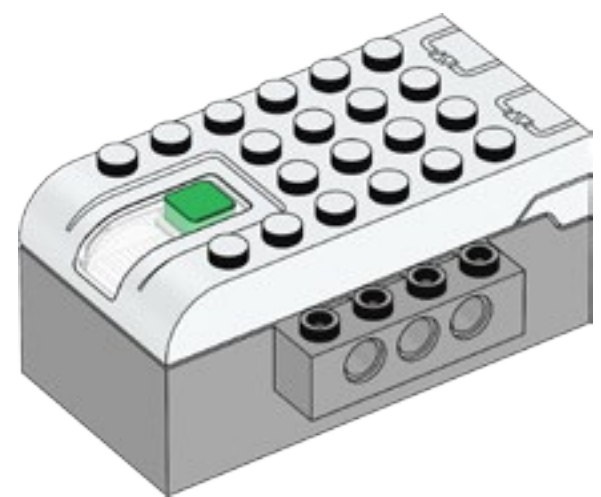

1x - Smarthub,
white. No.6096146

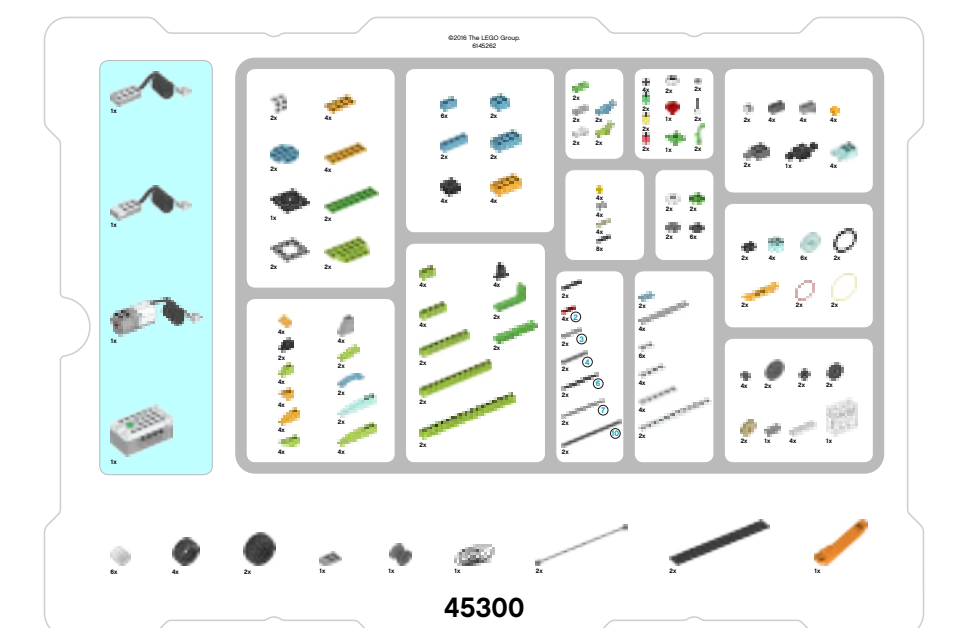

LEGO® Education WeDo 2.0



LEGOeducation.com

LEGO and the LEGO logo are trademarks of the/son des marques de commerce du/son marcas registradas de LEGO Group. ©2017 The LEGO Group. 2017.01.01. - VI.

