

1

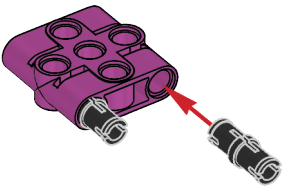



2x

2

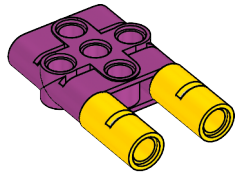

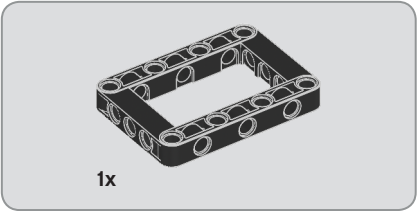

**3**

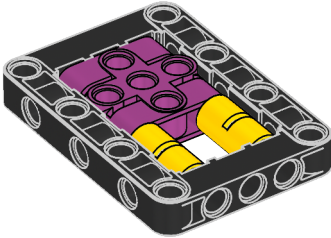



4x

4

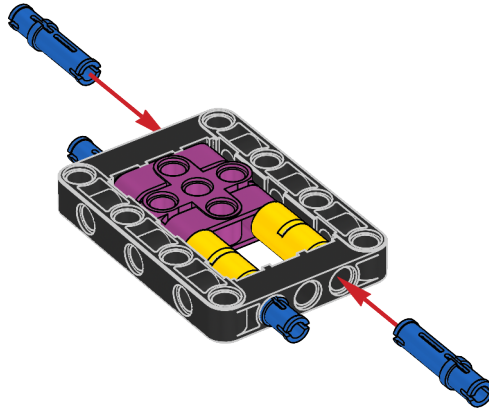

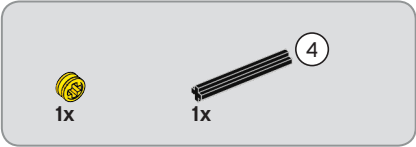
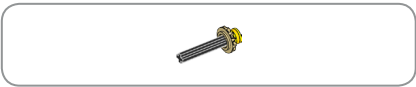

5





1x

6

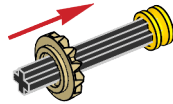



1x

7

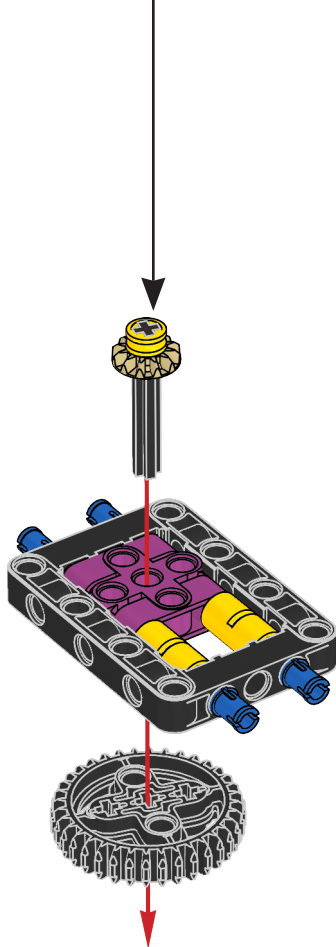



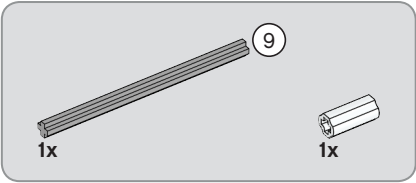
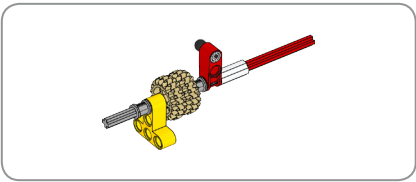

8

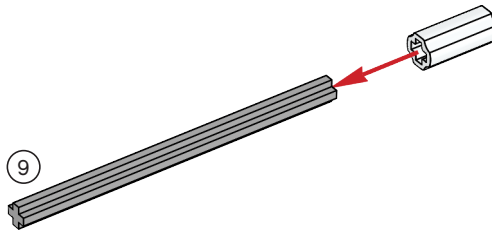



1x

9

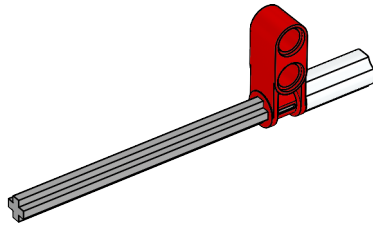



1x

10

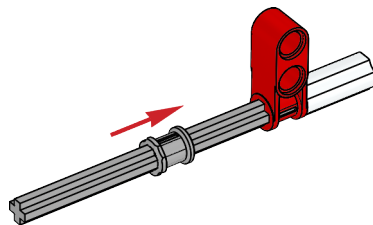



2x

11

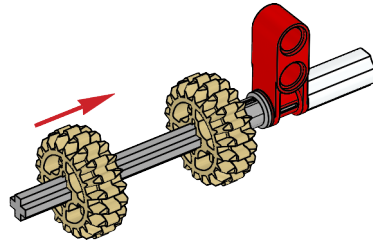



1x



1x

12

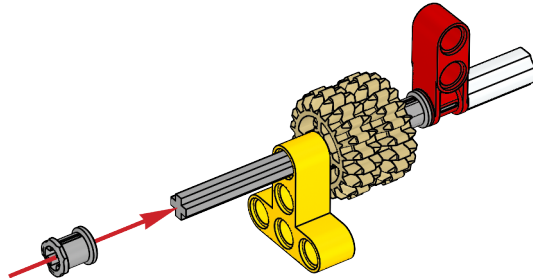

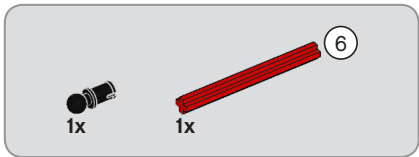

13

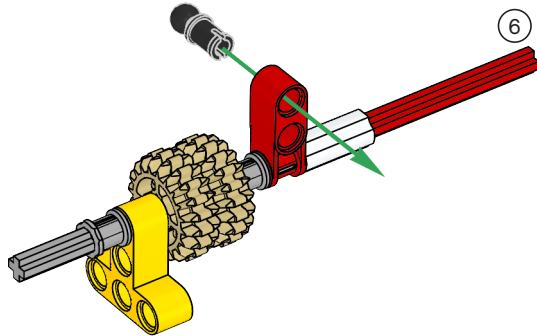

14

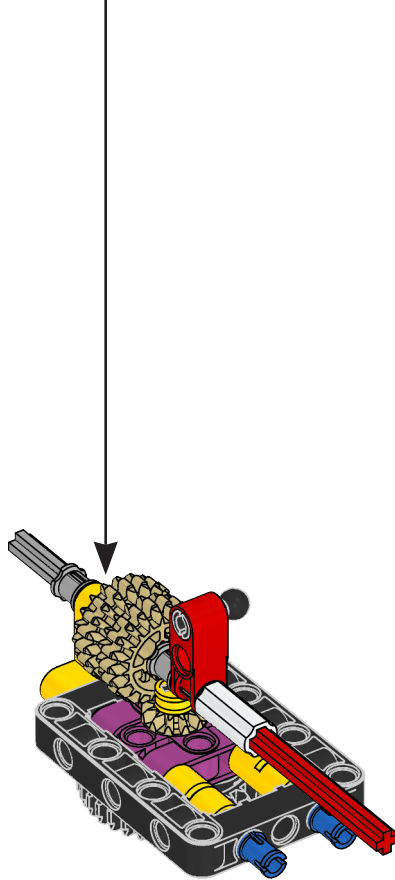

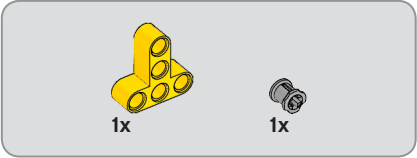

15

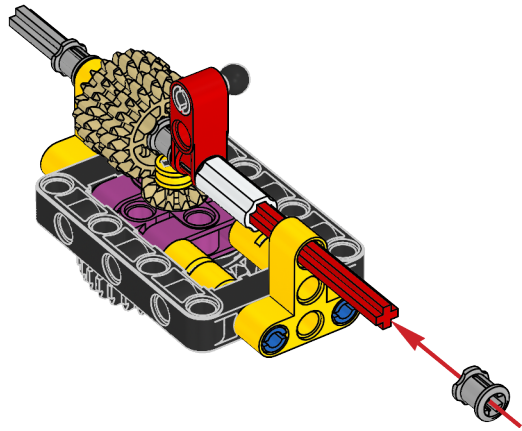



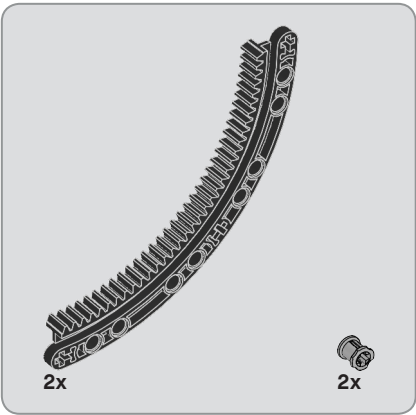

16

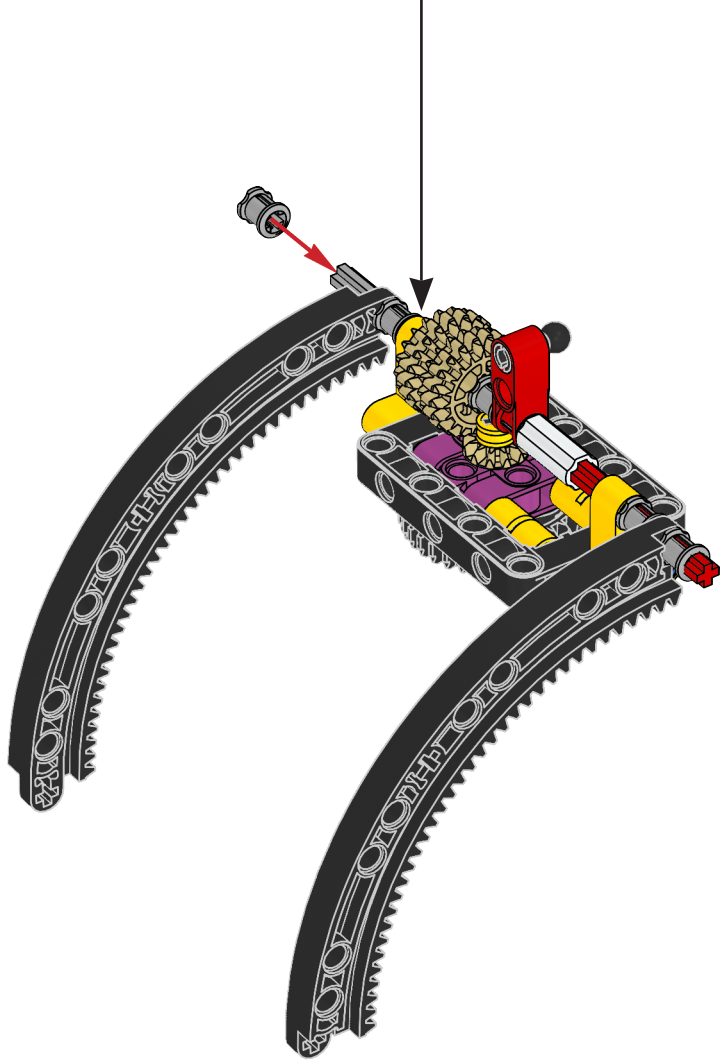

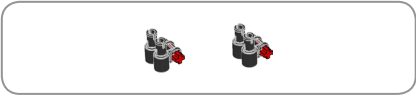

17

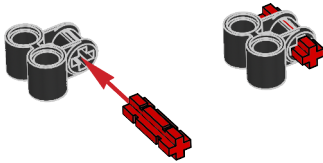



4x

18



19

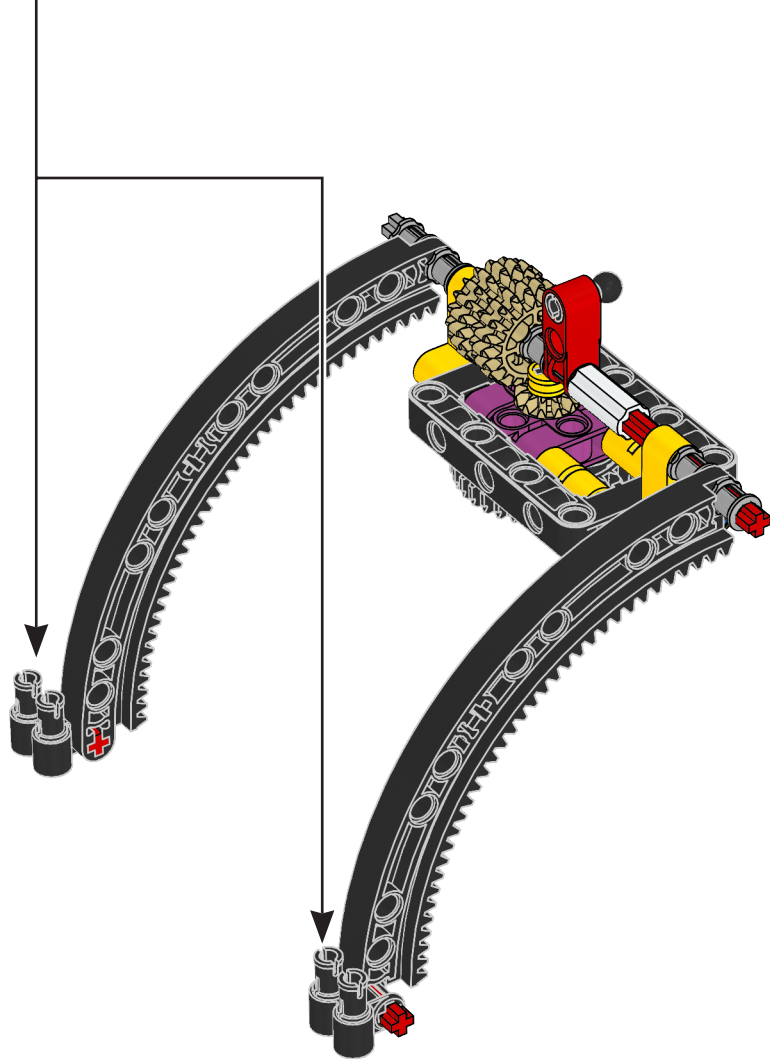



4x

20

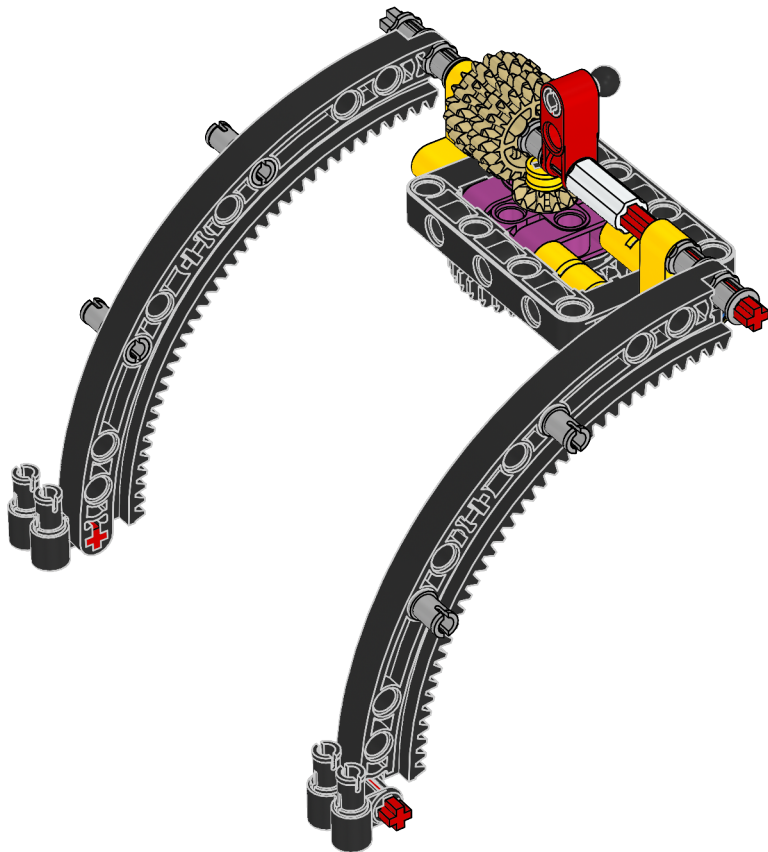

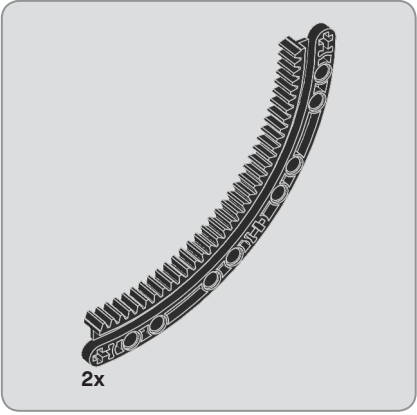

21

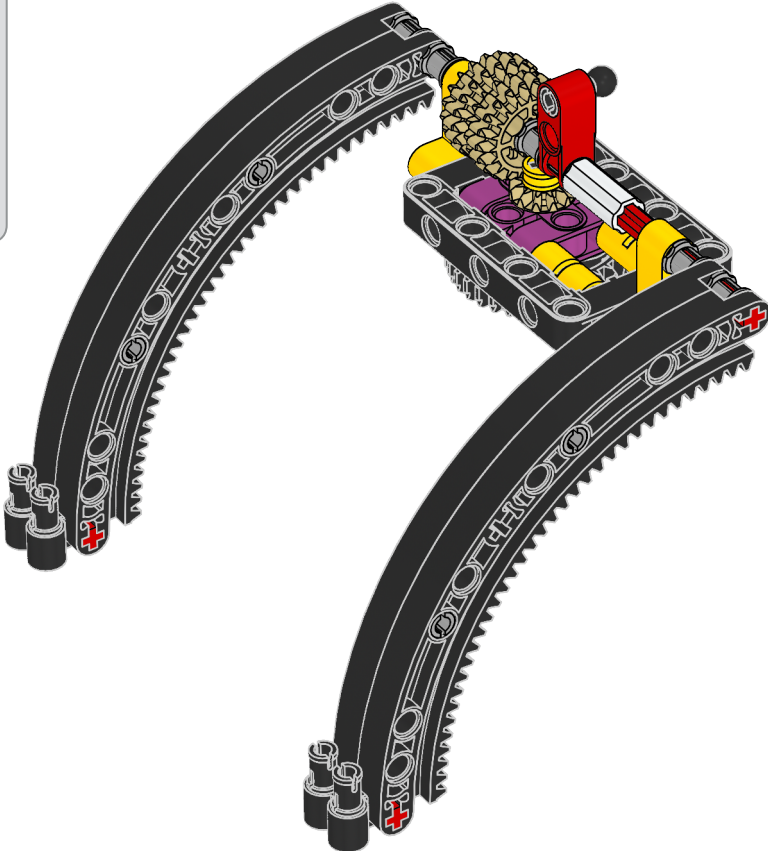

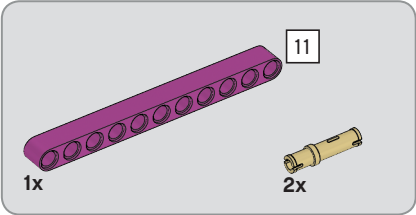
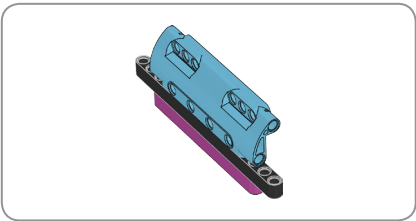

22

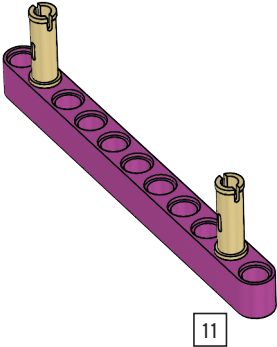

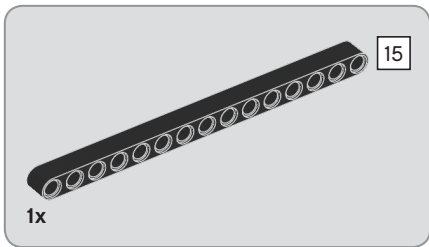

23

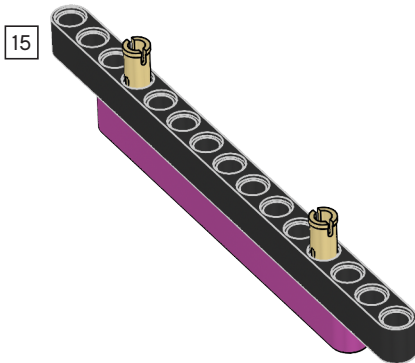



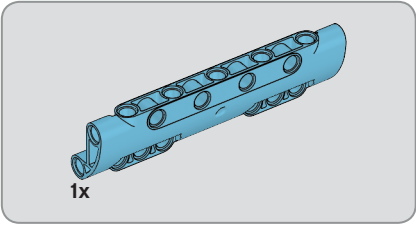

24

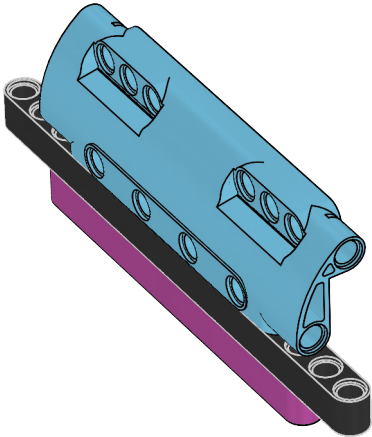

25

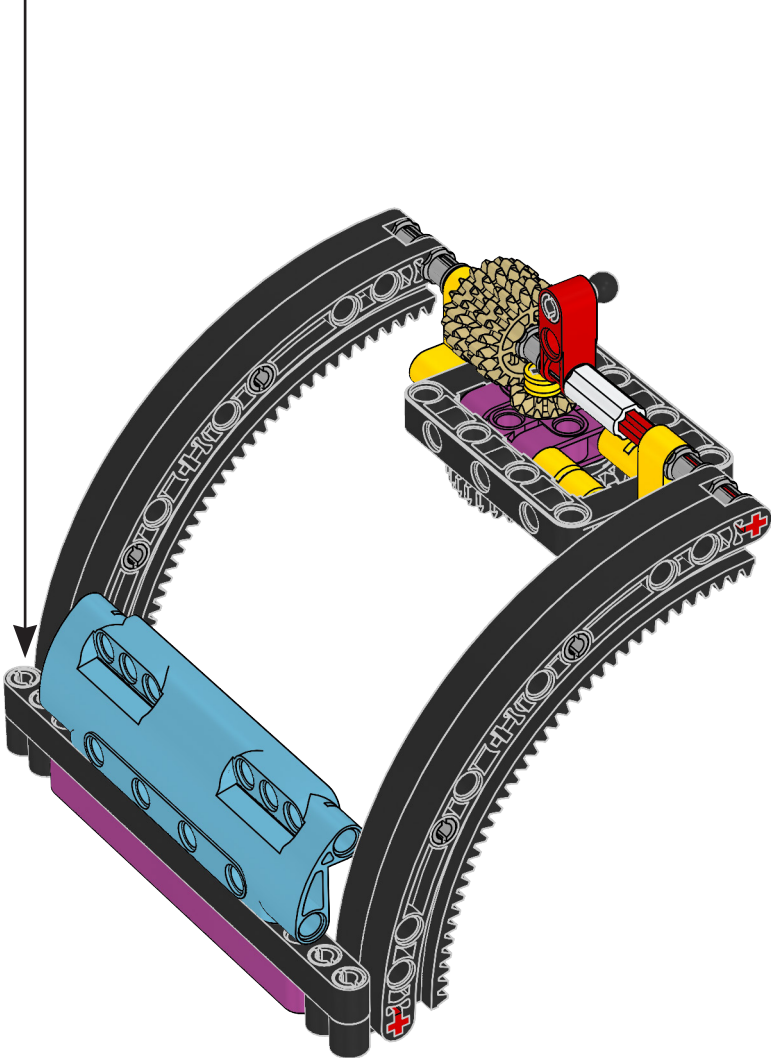

26

