

1

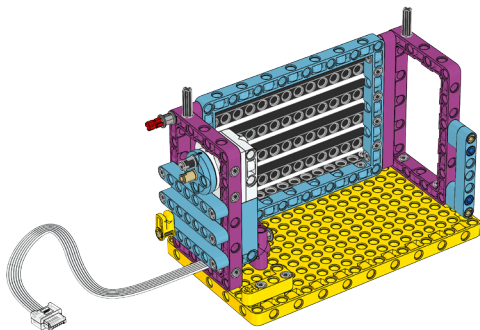

+

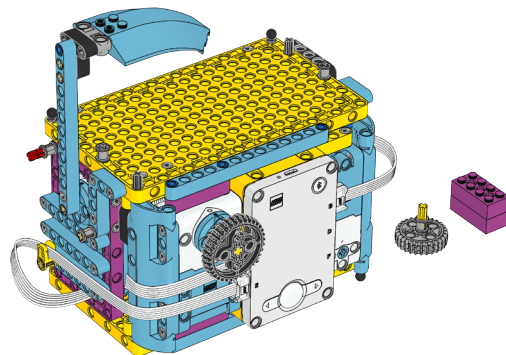

2

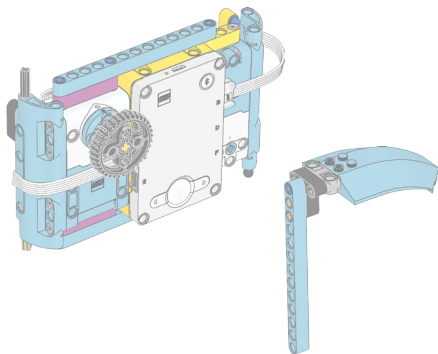

1 x





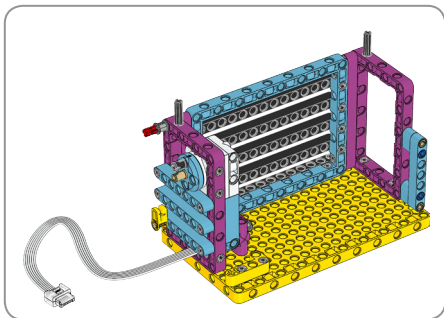

2x

1

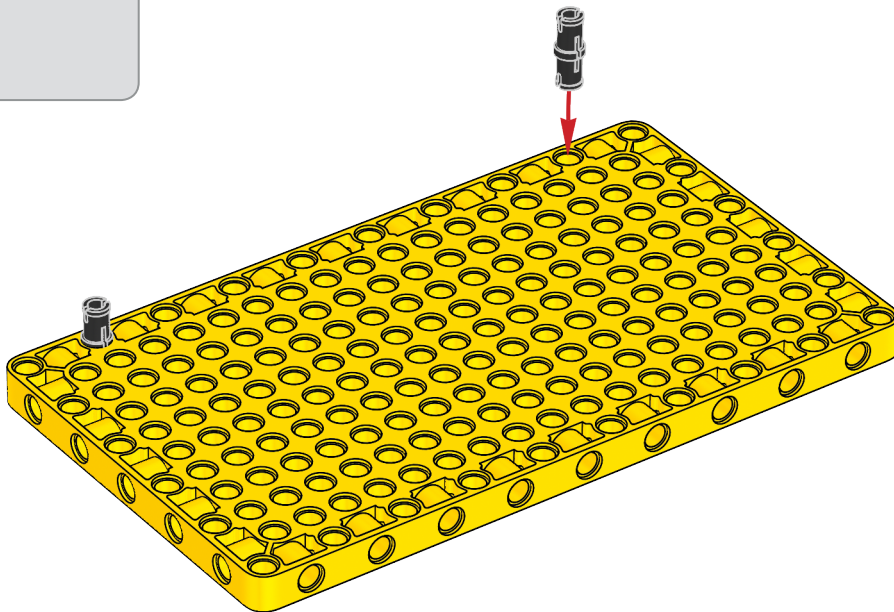

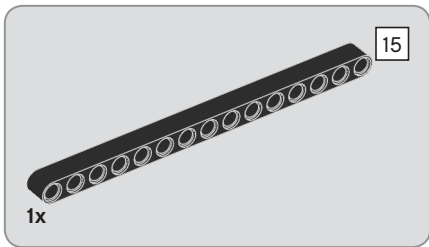

2

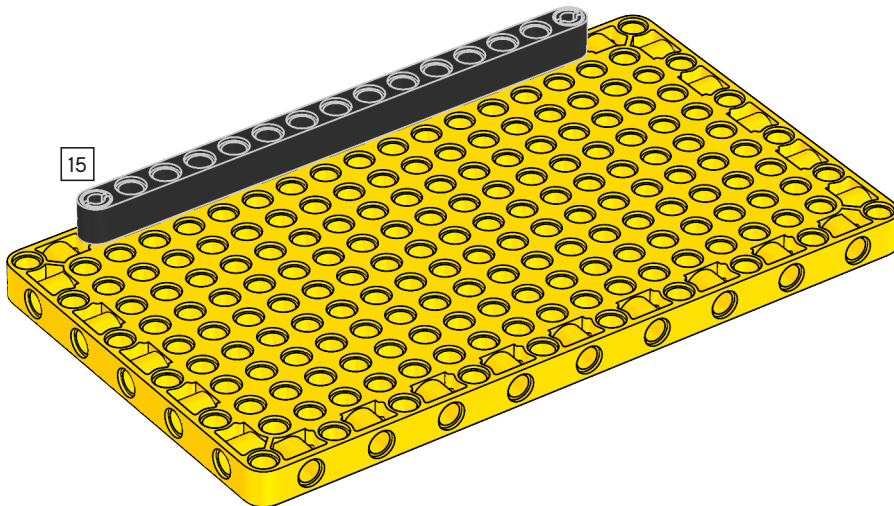



4x

3

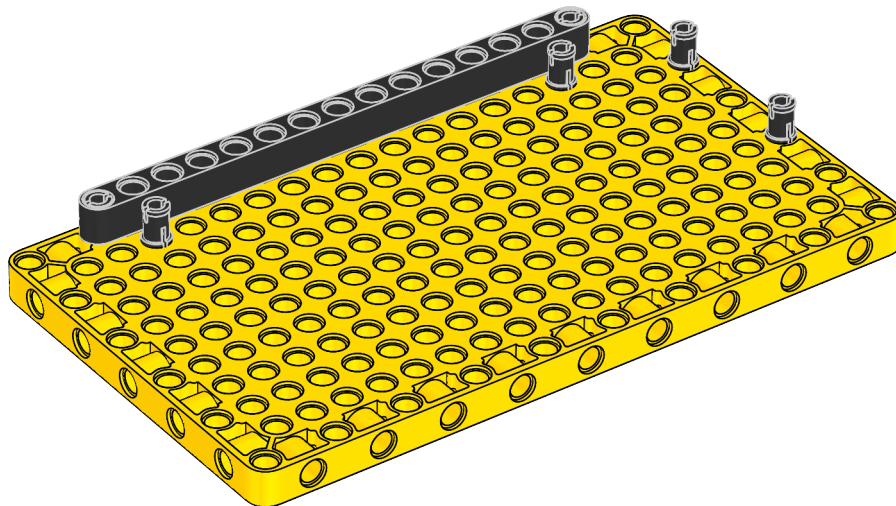

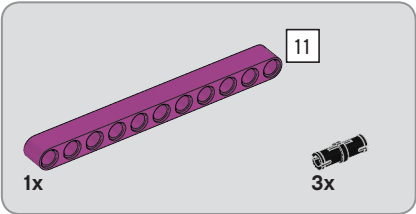
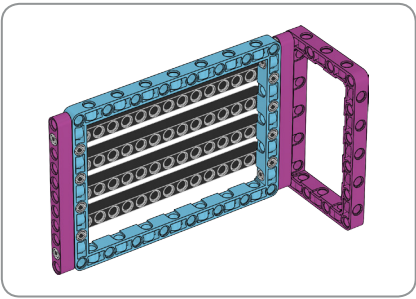

4

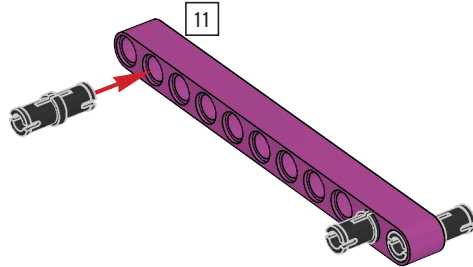

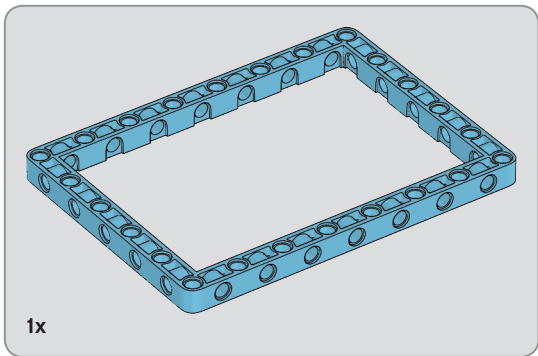

5

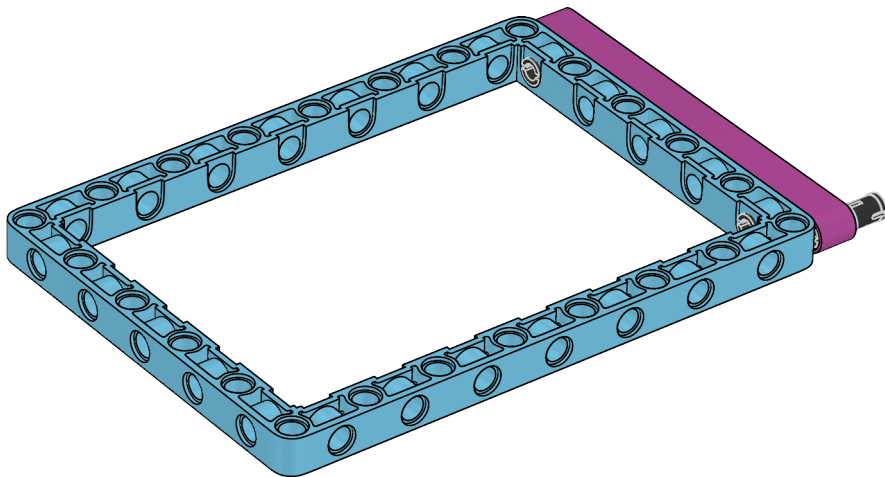



8x

6

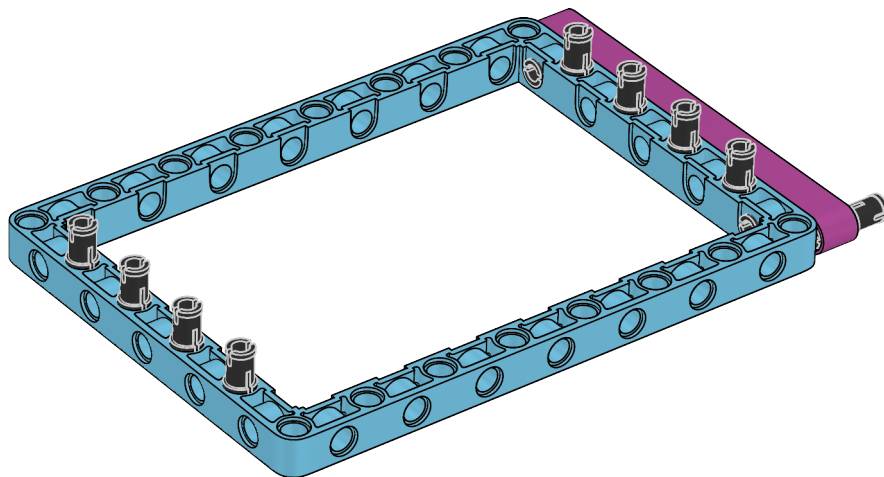

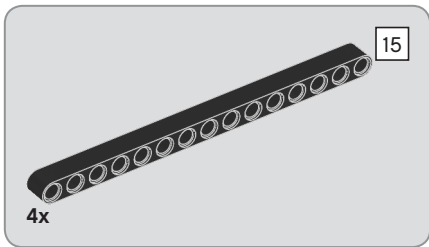

7

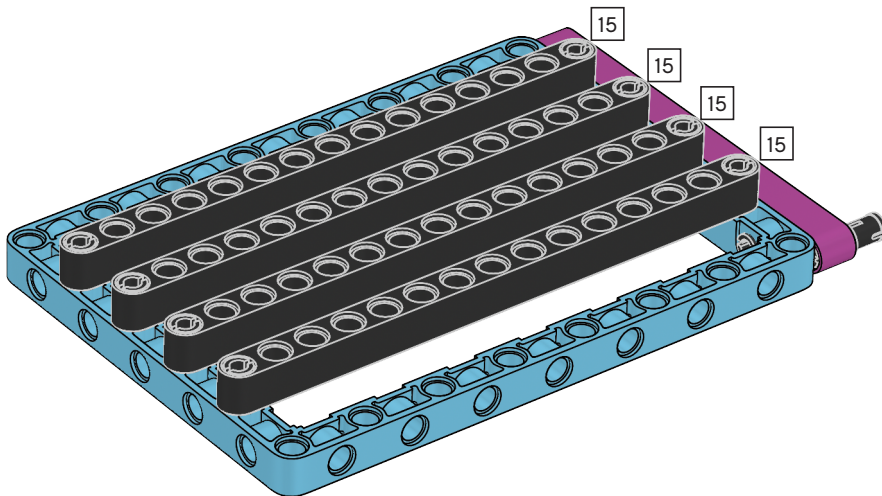



2x

8

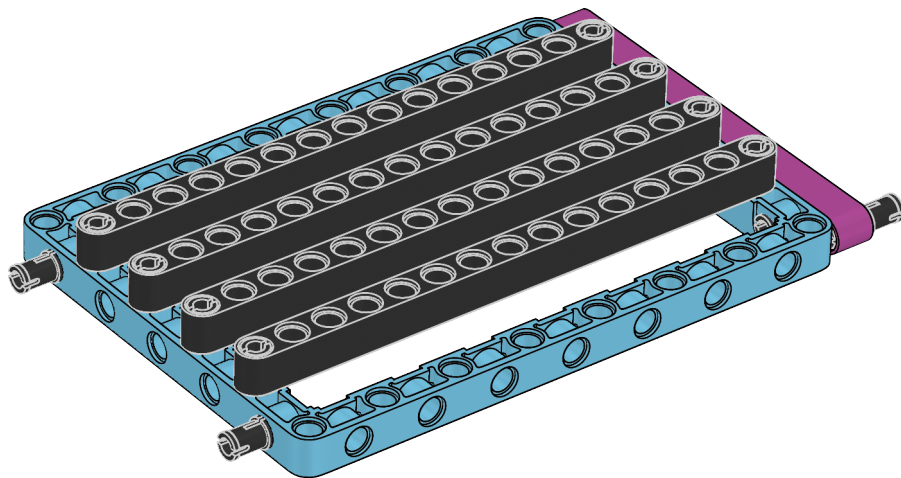



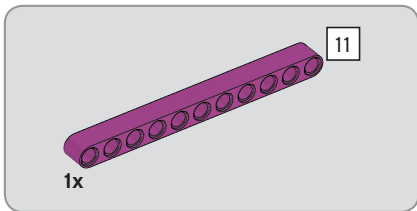

9

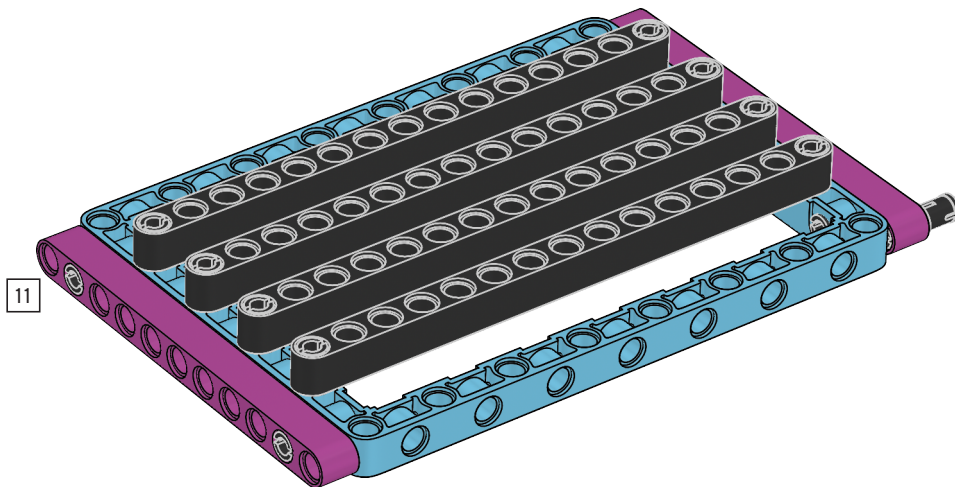

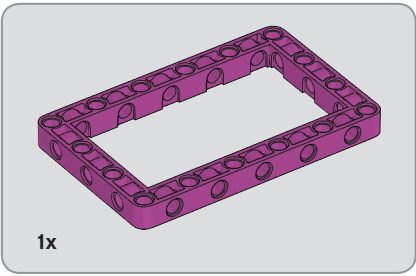

10

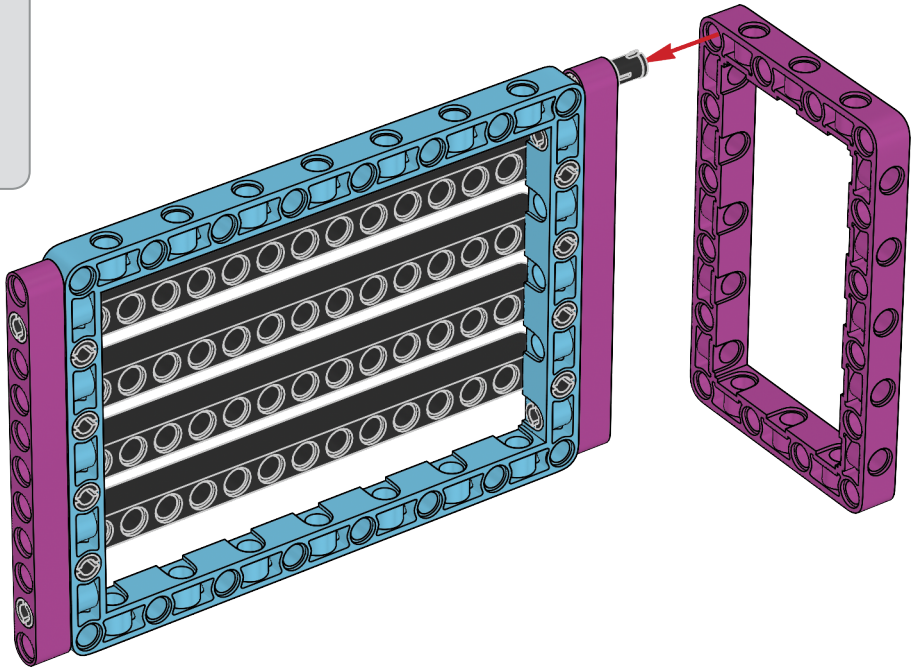

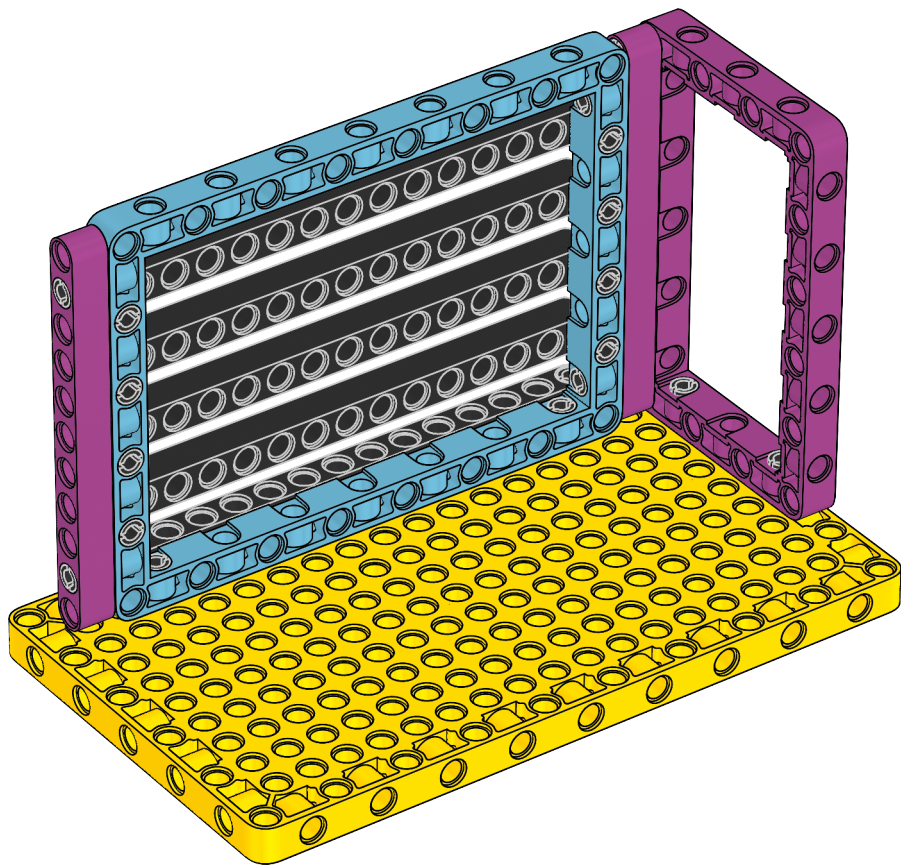

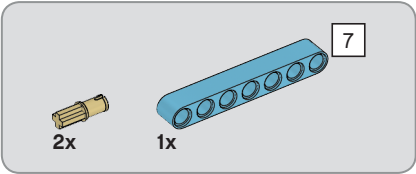
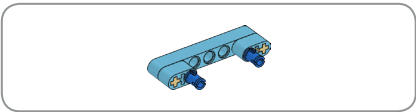

12

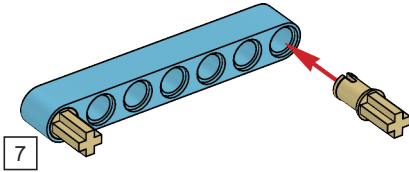



2x

13

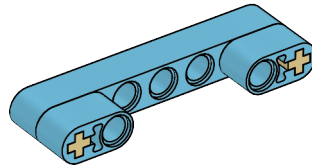



2x

14

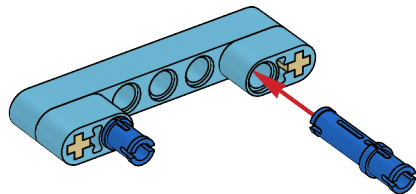

15

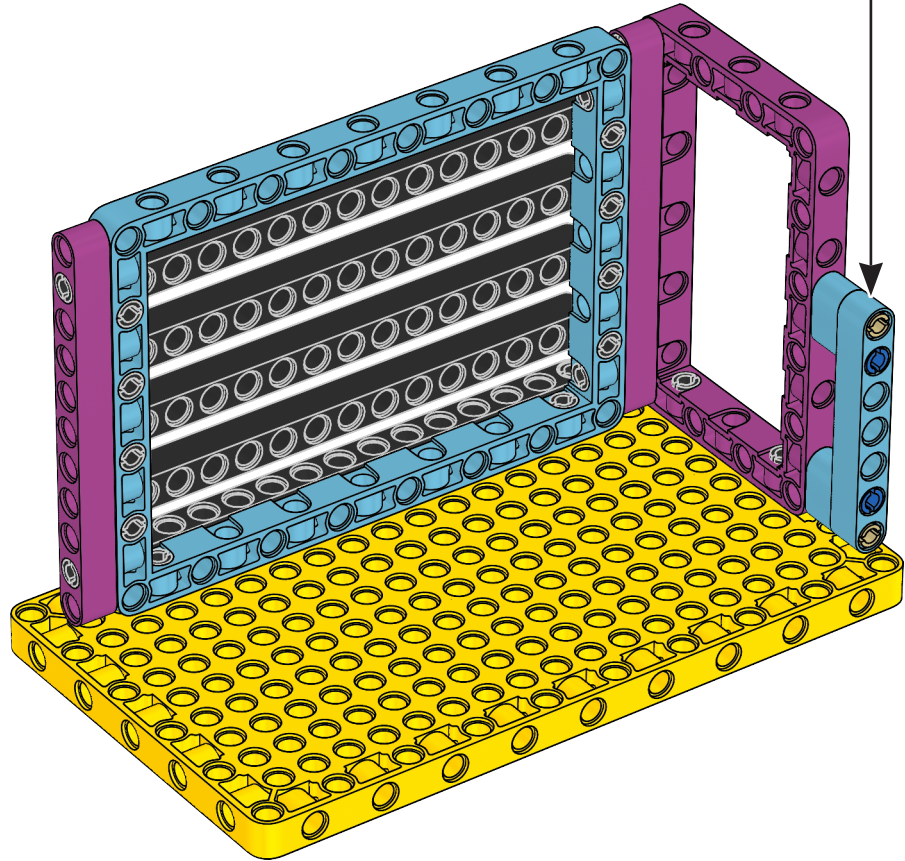



6x

16

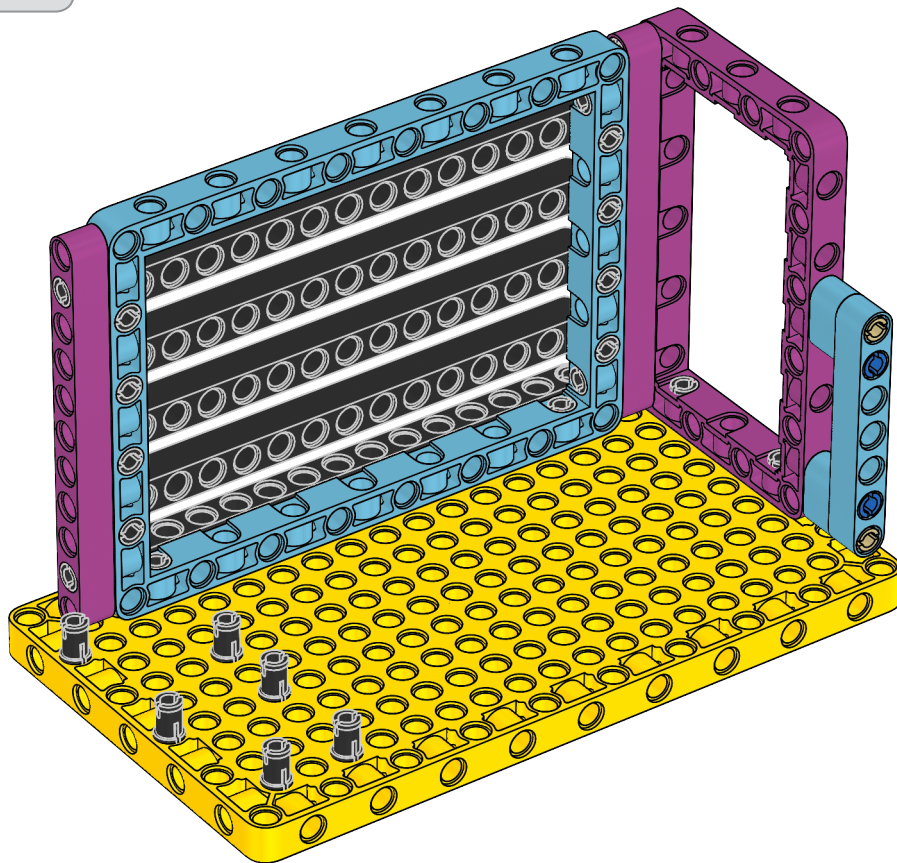



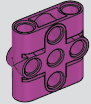

1x

17

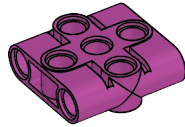



18

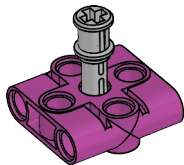

19

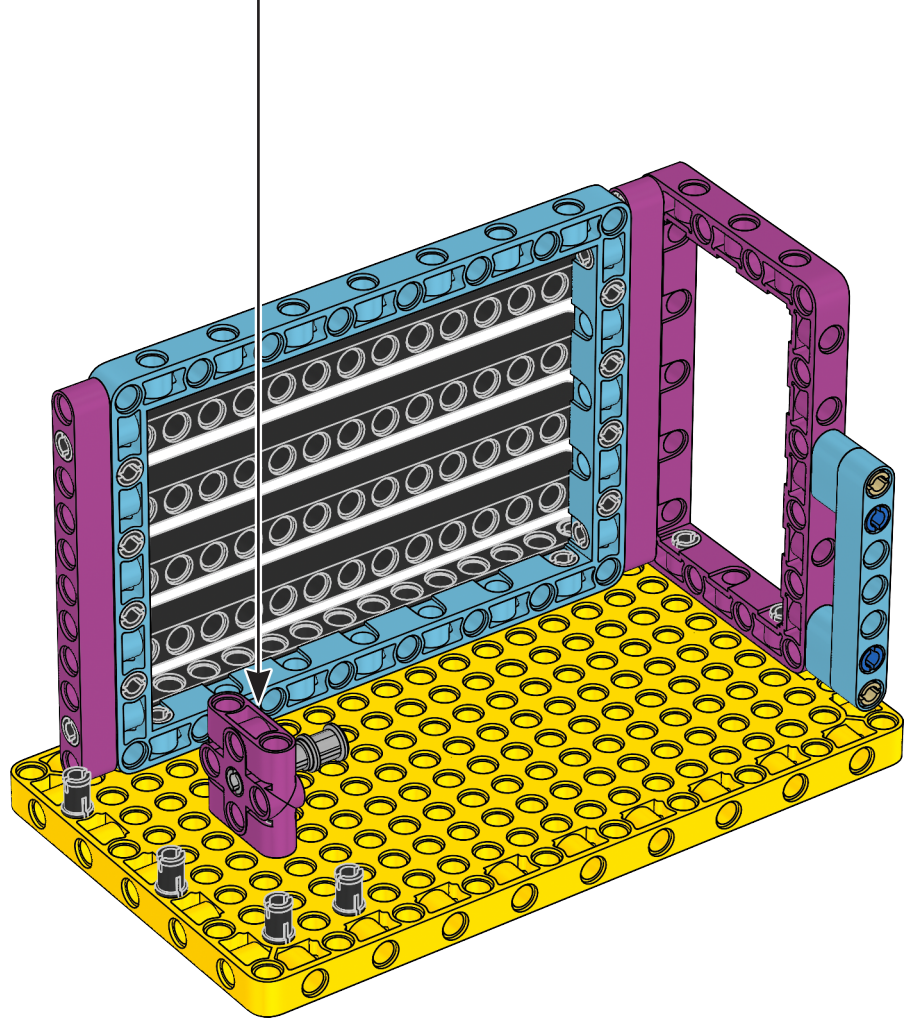

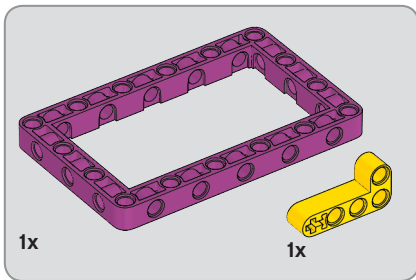

20

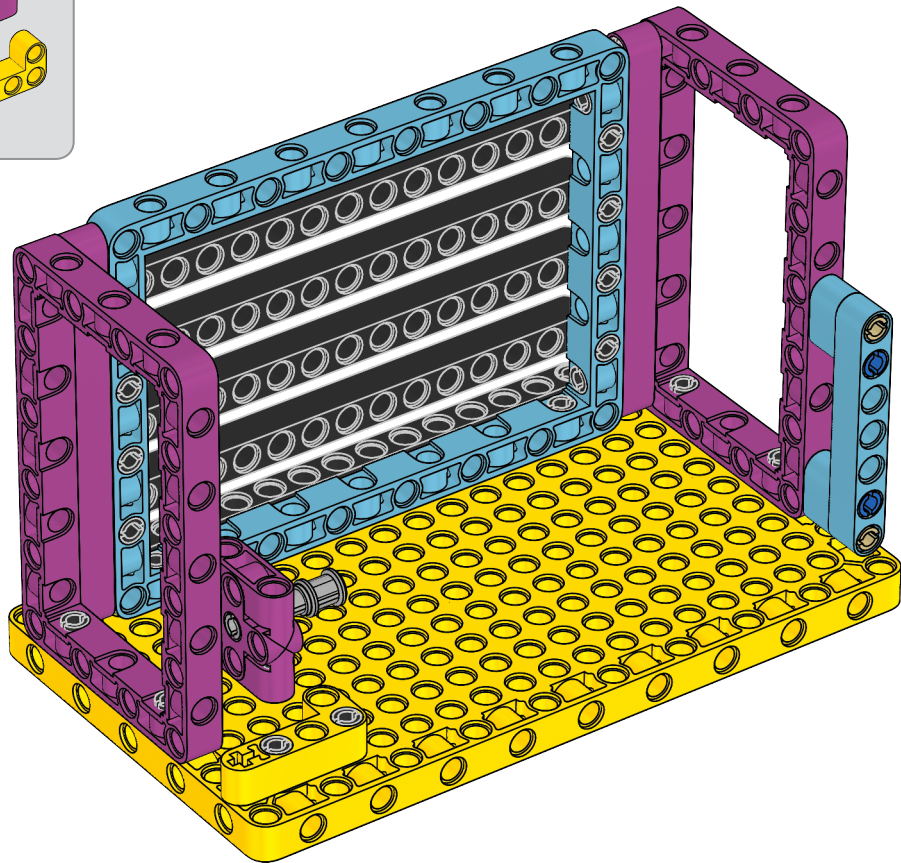

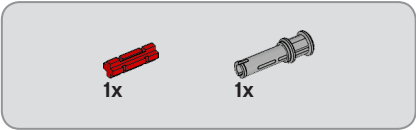

21

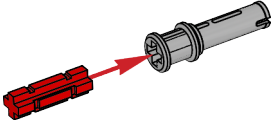

22

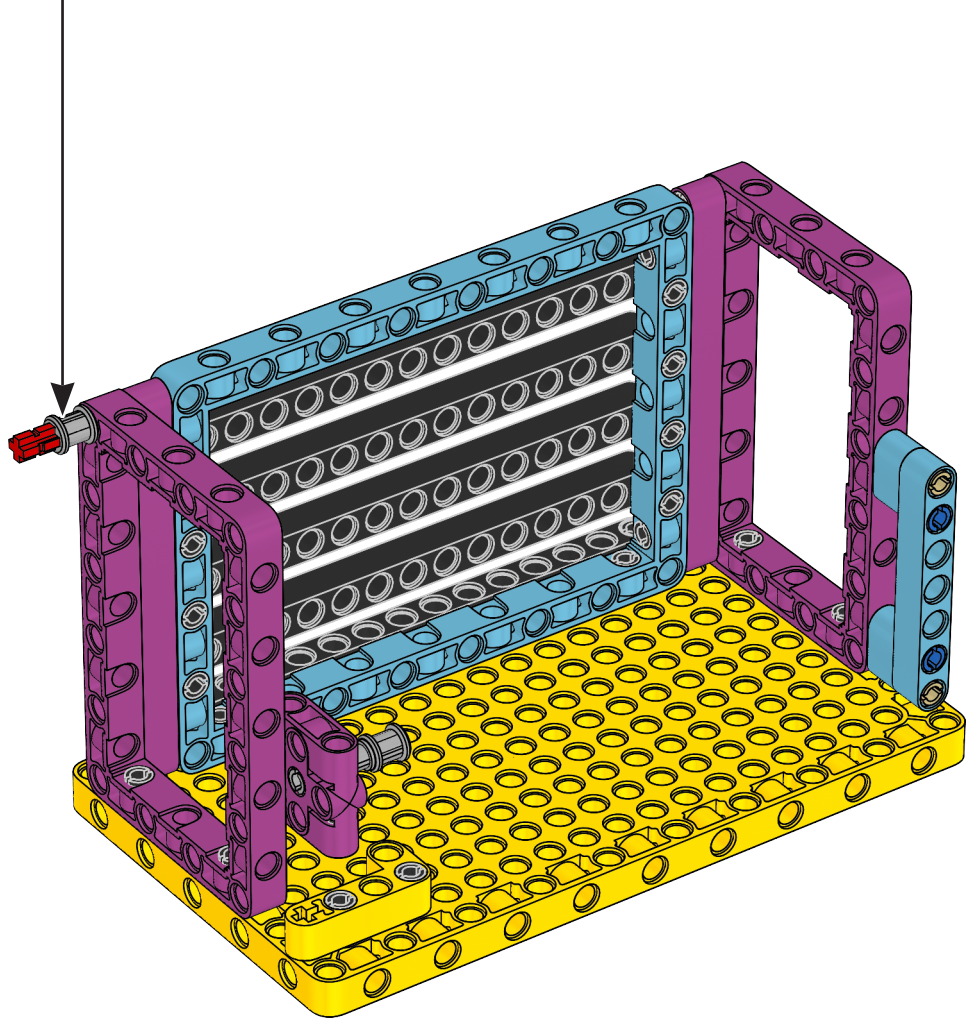

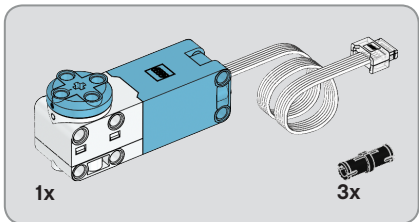
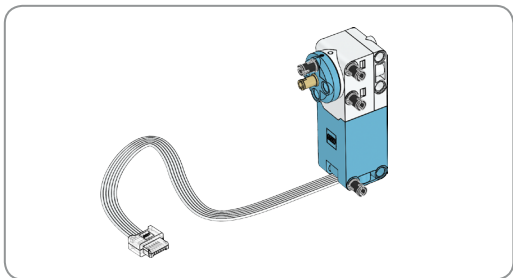

23

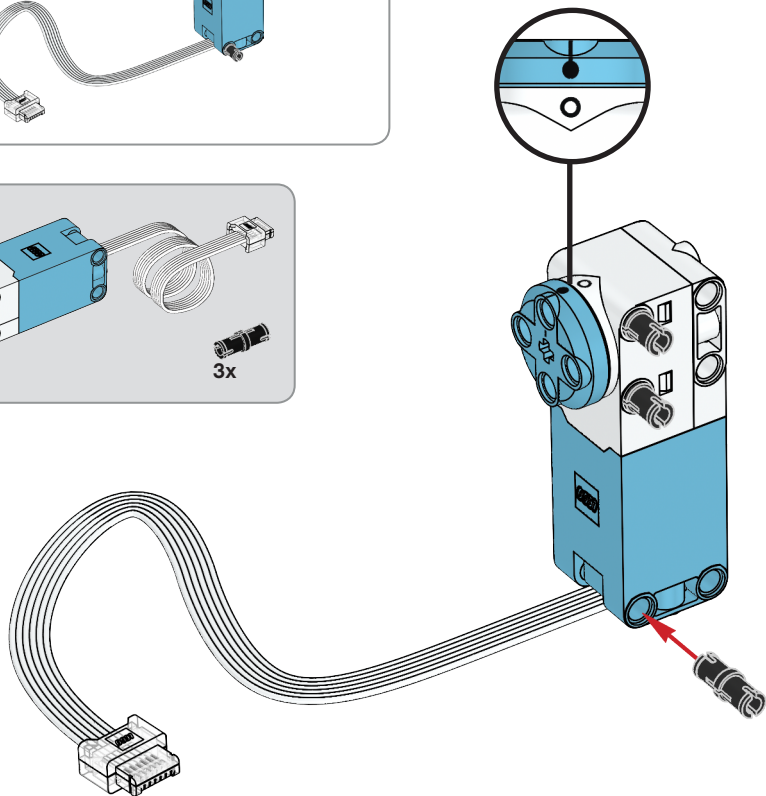



1x



1x

# 24

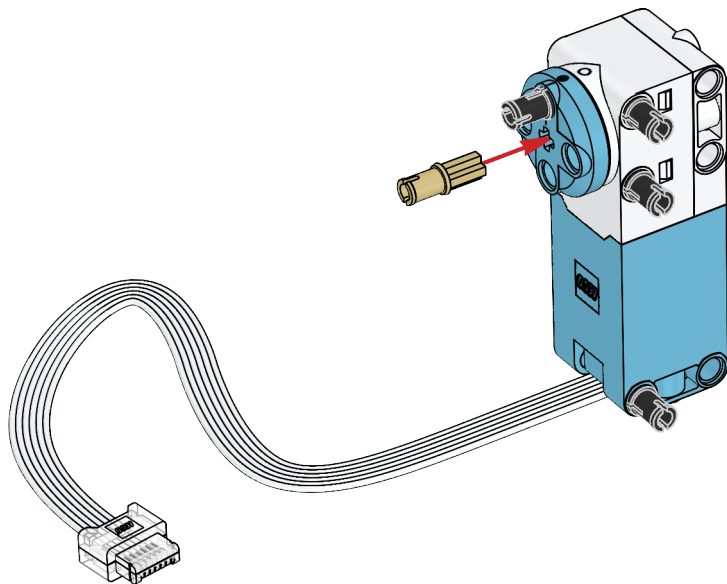



25

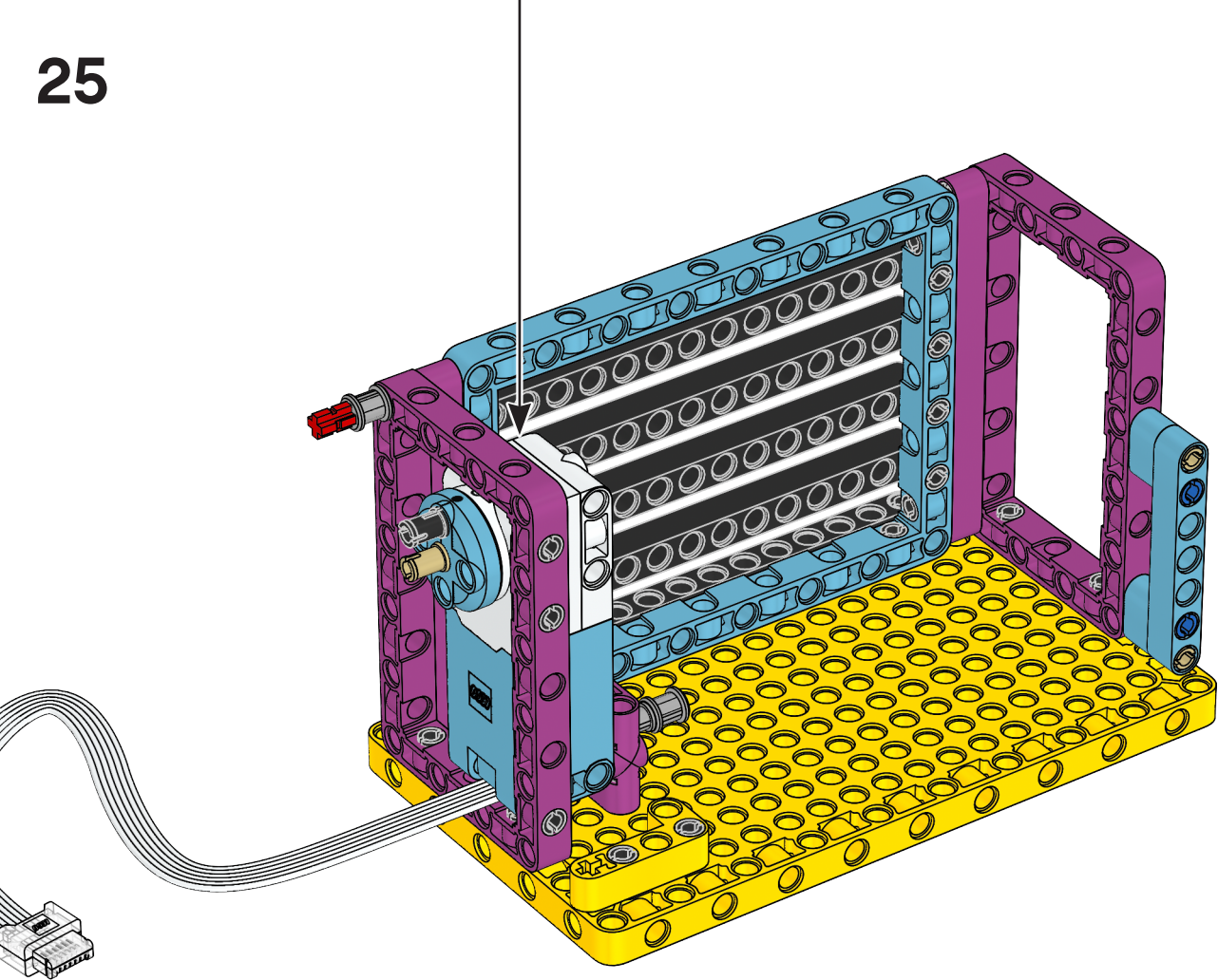

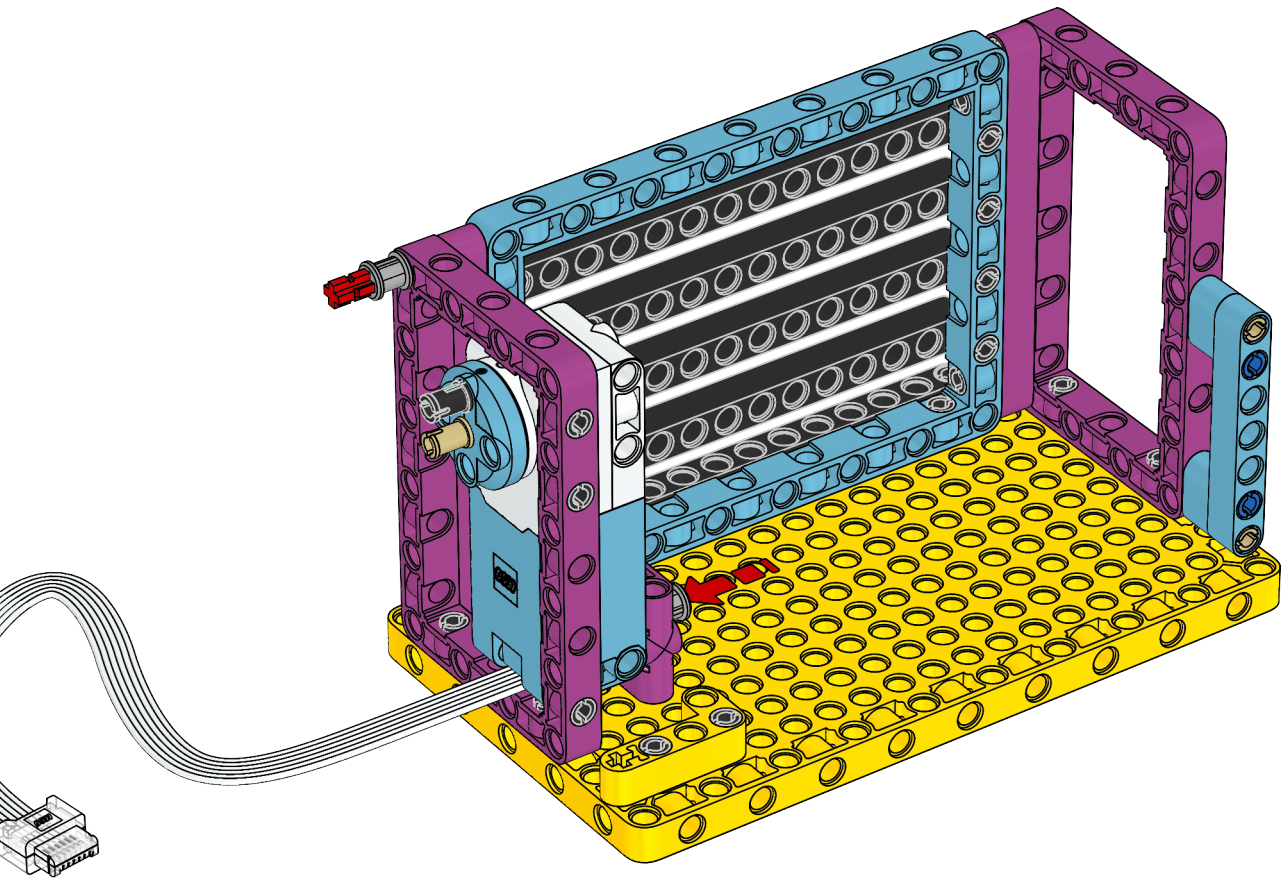

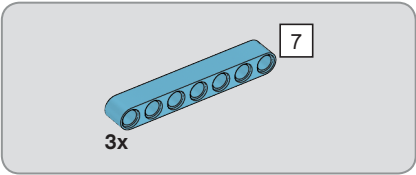
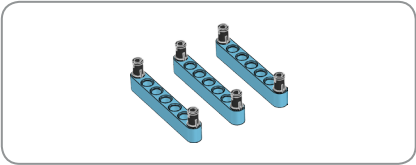

27

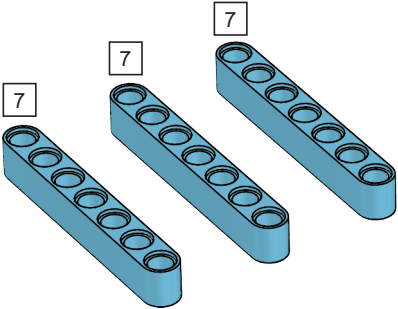



6x

28

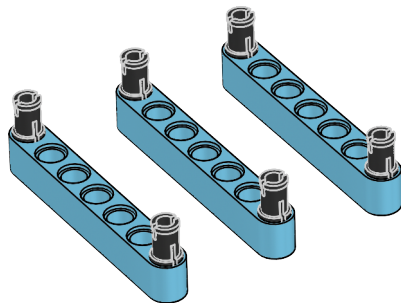

29

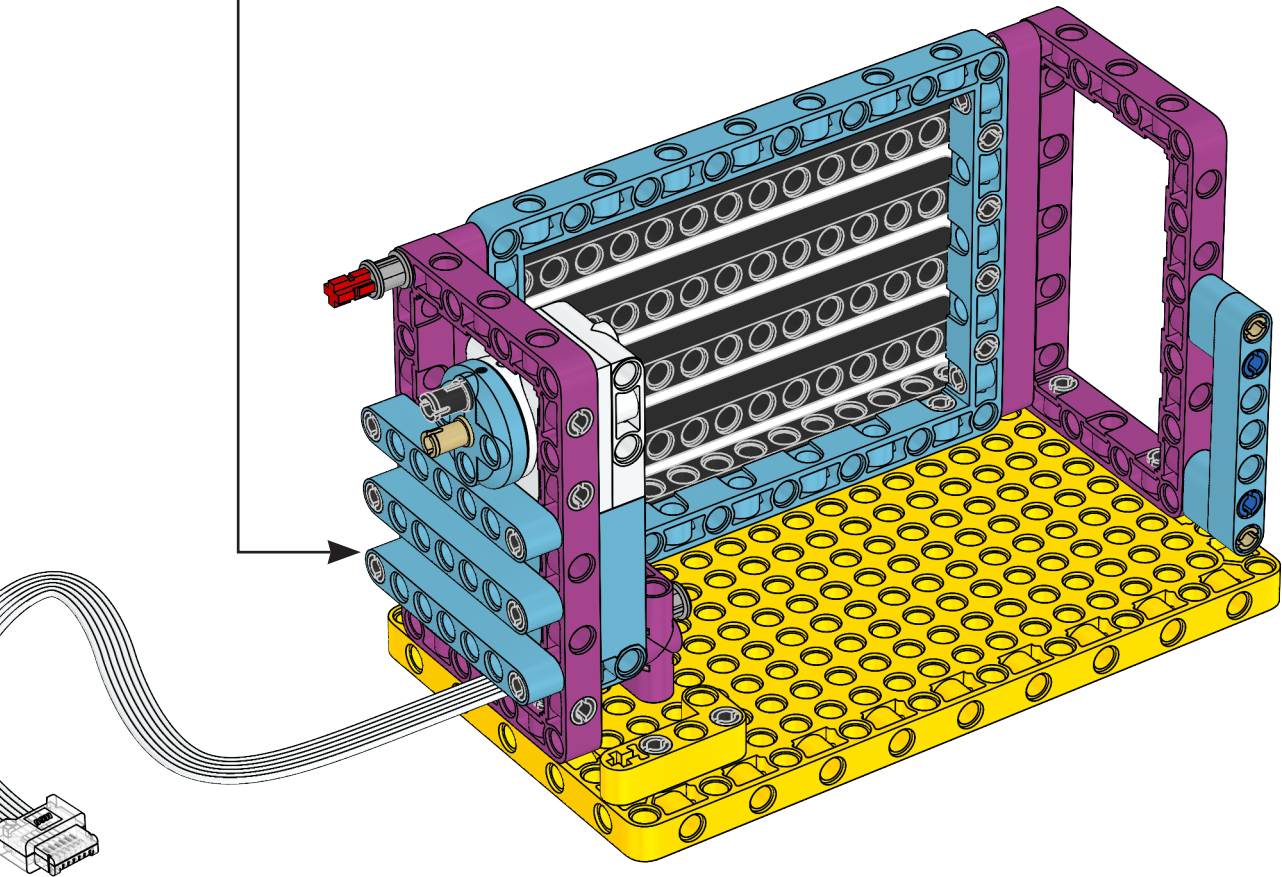





1x



1x

30

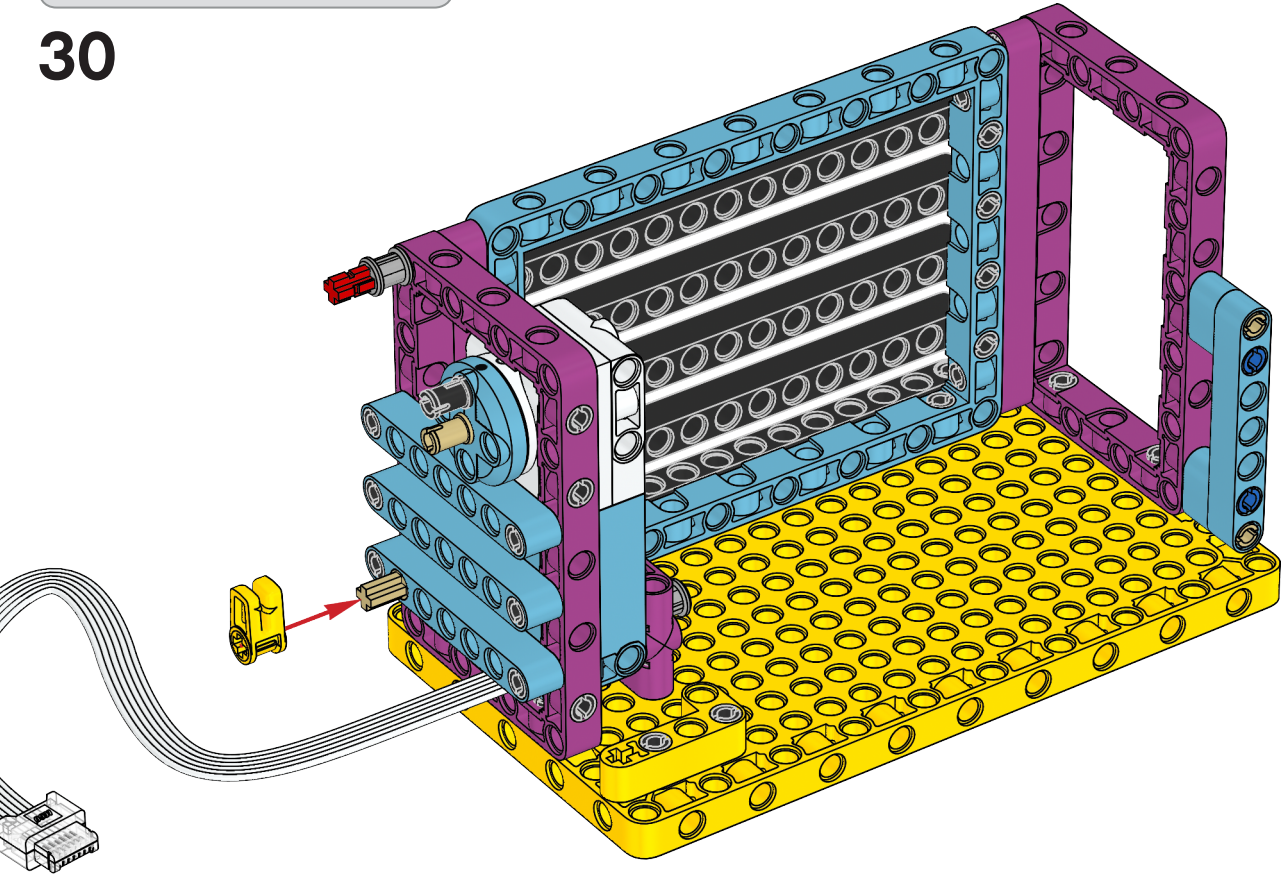



2x

31

