





















- 1x 
- 1x 
- 4x 
- 4x 
- 1x 
- 1x 
- 1x 
- 1x 
- 4x 
- 1x 
- 2x 
- 2x 
- 1x 
- 1x 
- 4x 
- 1x 
- 2x 
- 1x 
- 2x 
- 1x 
- 1x 



1

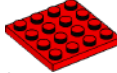

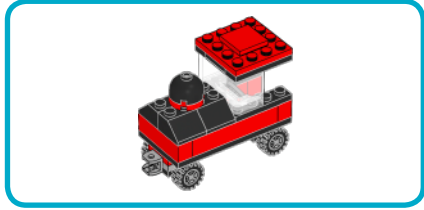
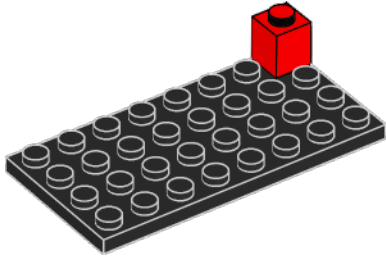
2

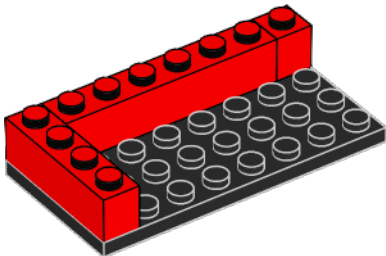

3

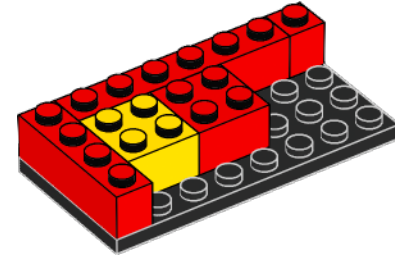

4

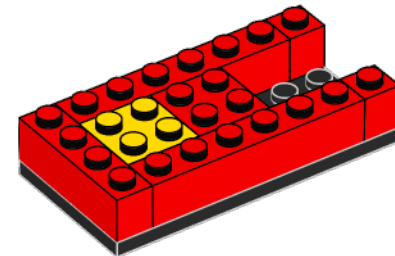

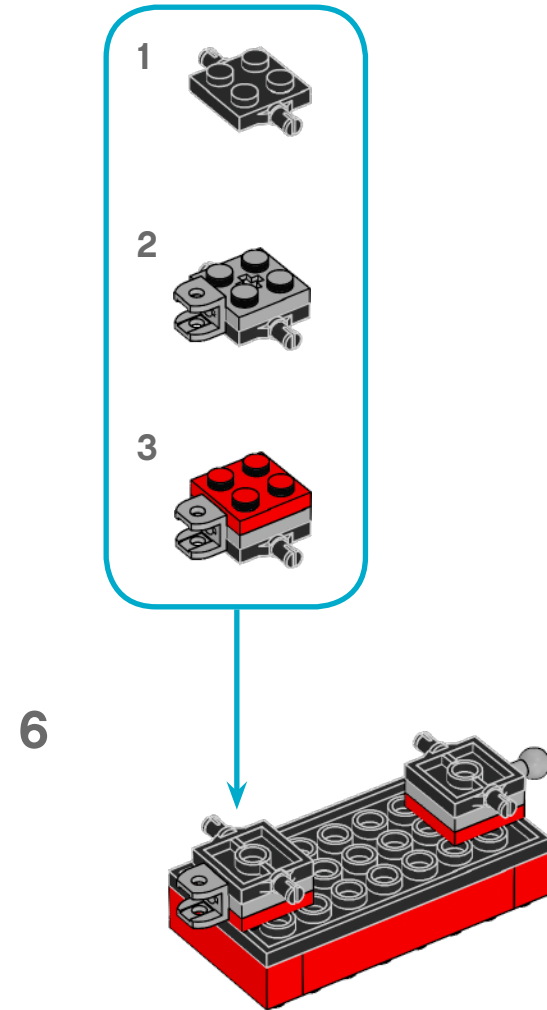
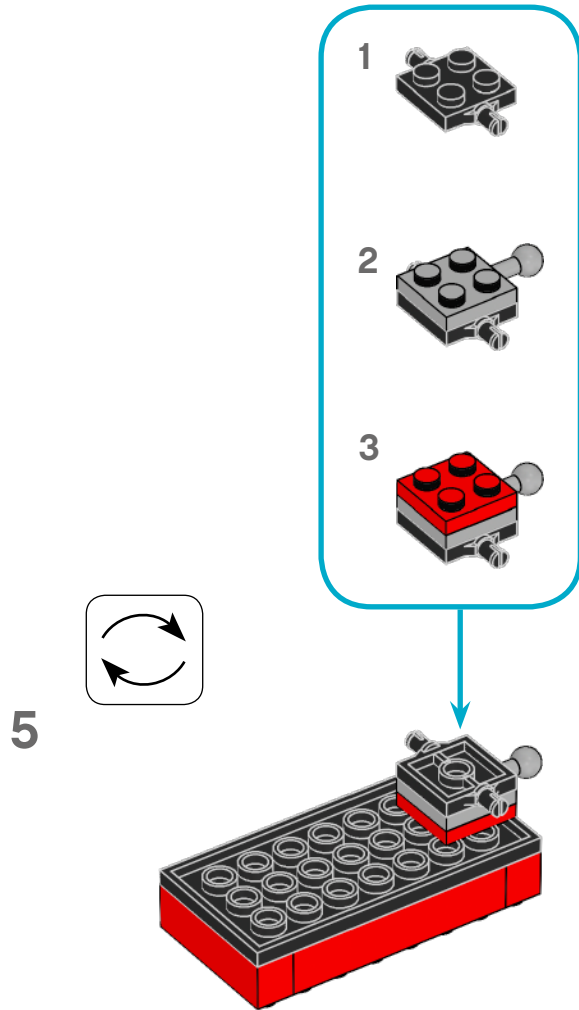



7

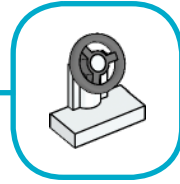
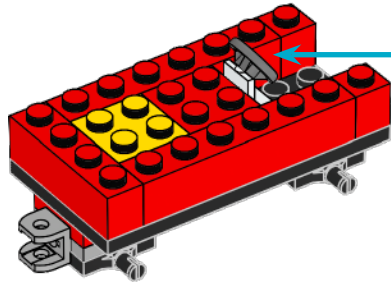
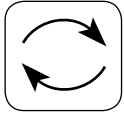

9

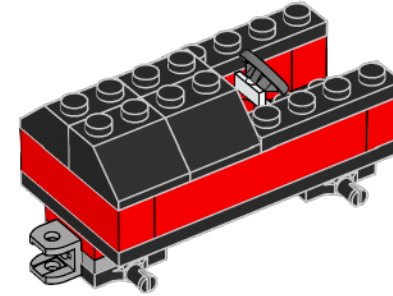

8

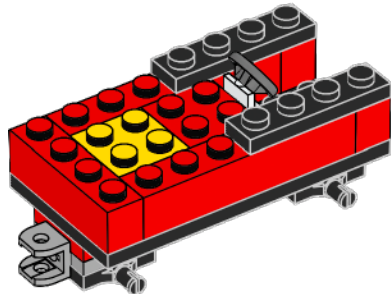

10

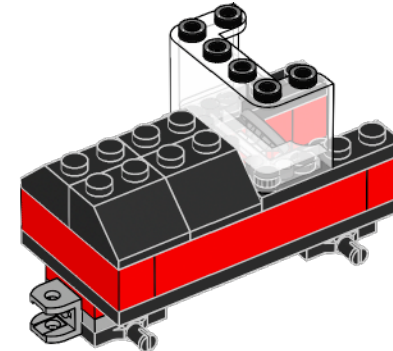



11

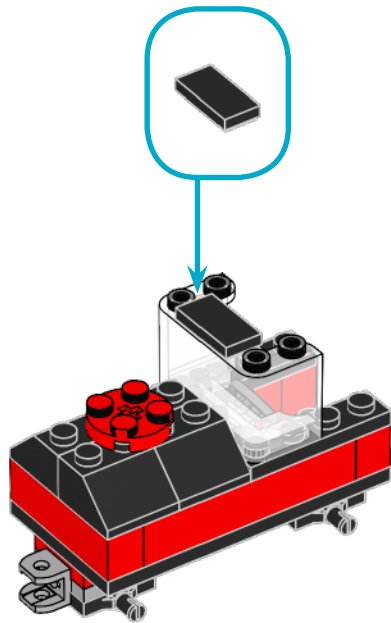

12

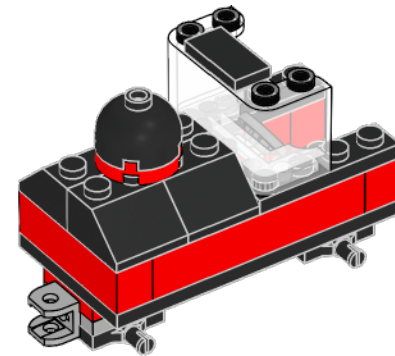

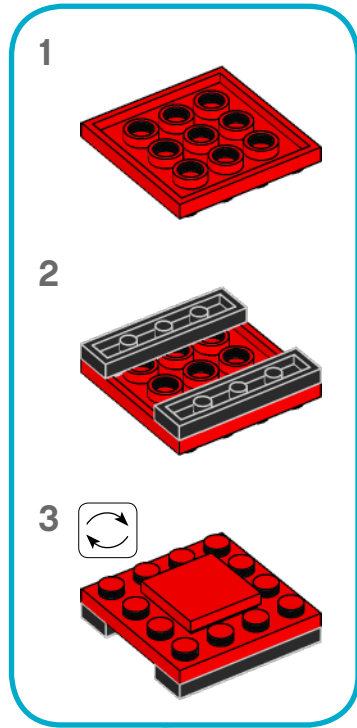

13

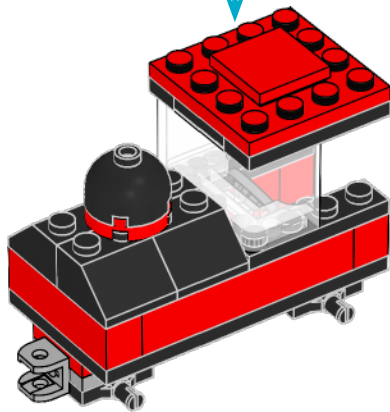

14

