

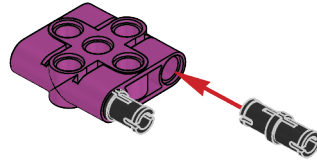

1 x

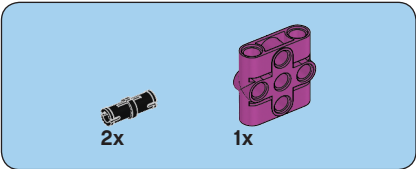

1 x

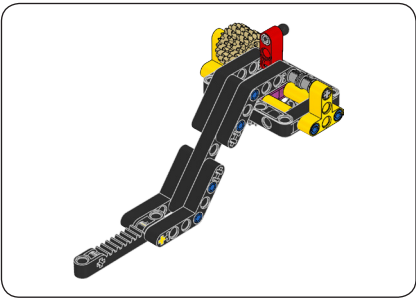

1



2

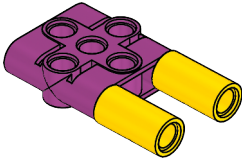

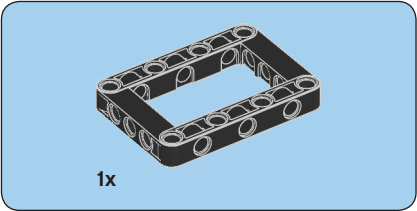

3

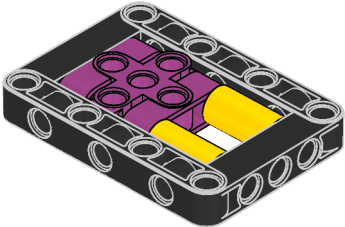



4x

4

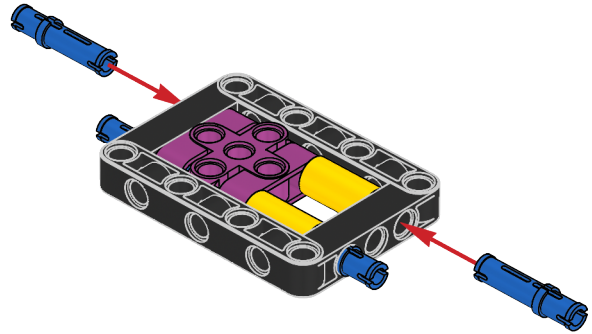

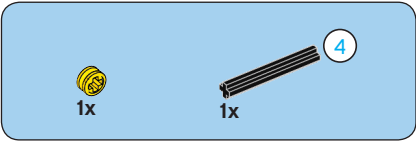

5





1x

6

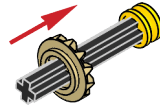



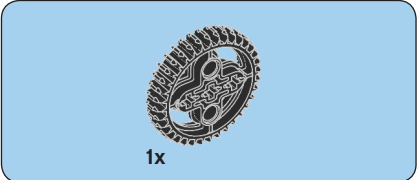

7

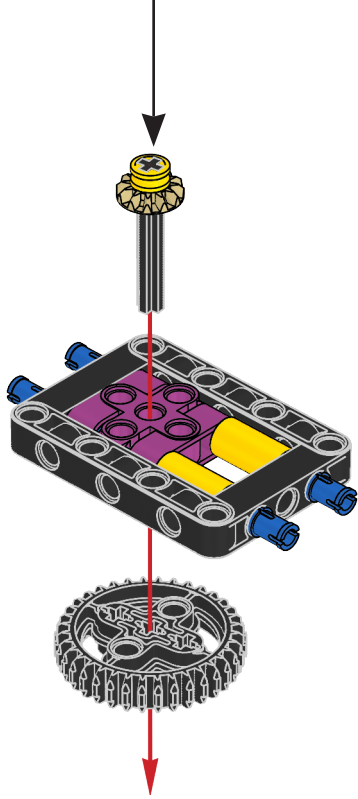



1x

8

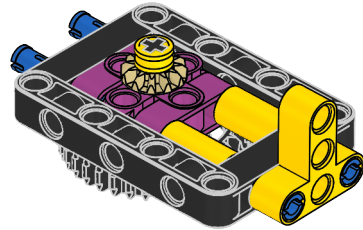

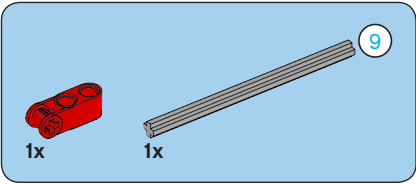
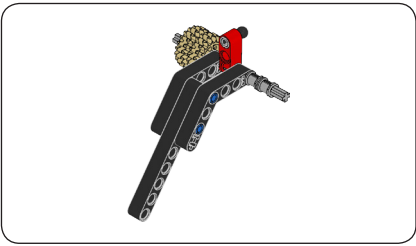

9

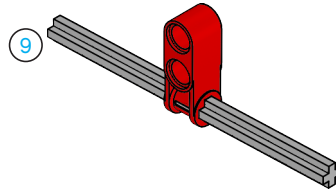

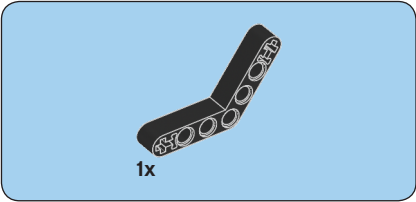

10

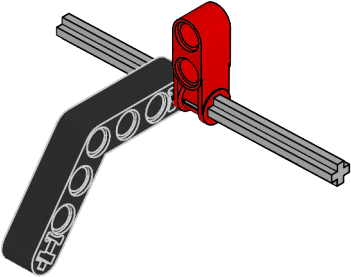



2x

11

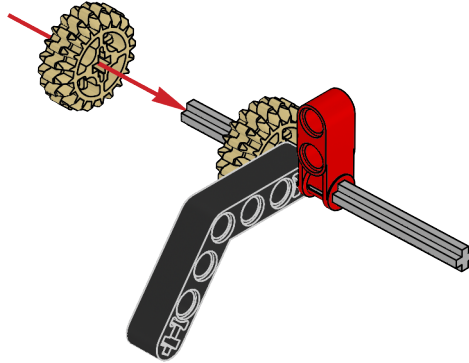



12

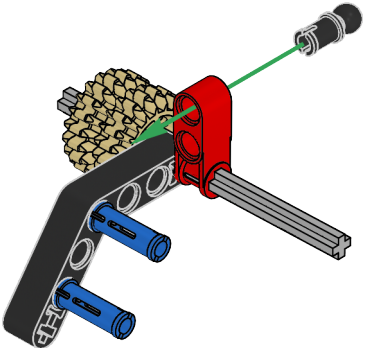

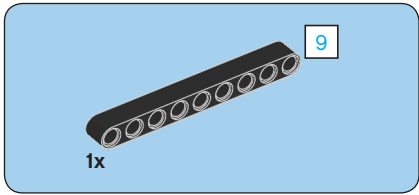

13

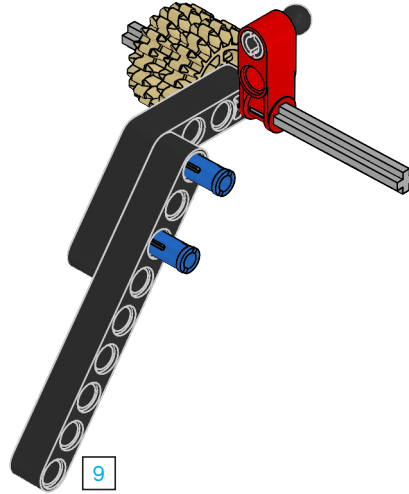

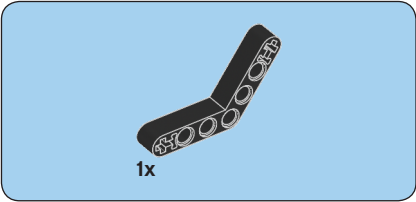

14

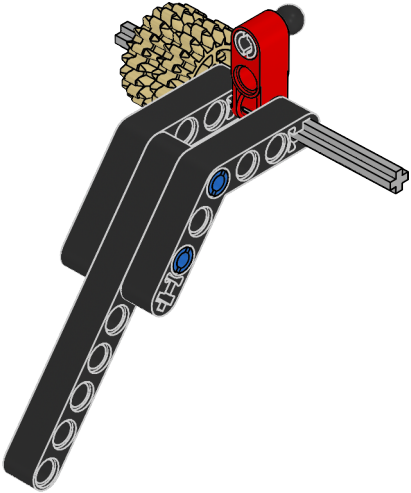





2x

15

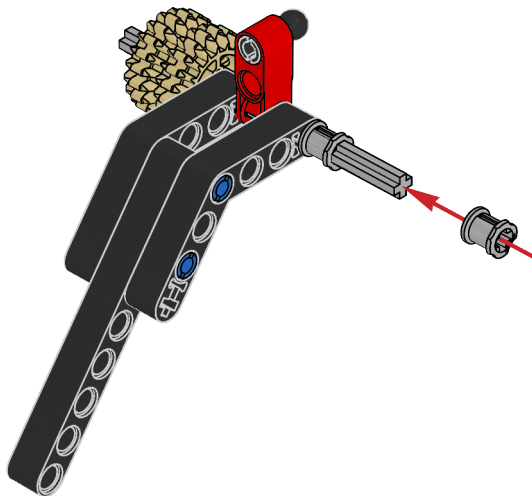

16

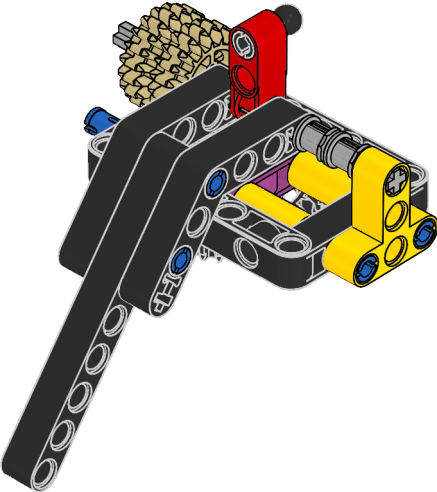



1x

17

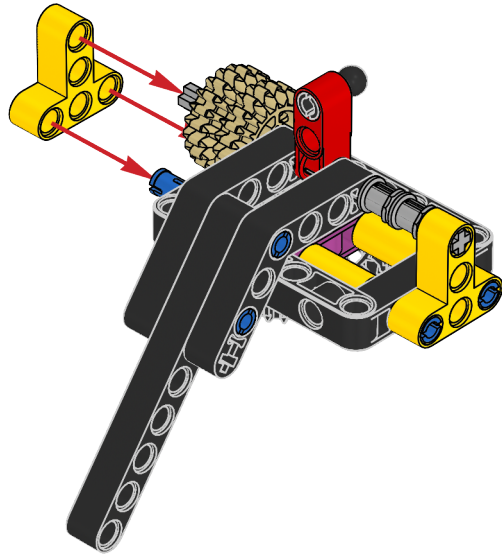



2x

18

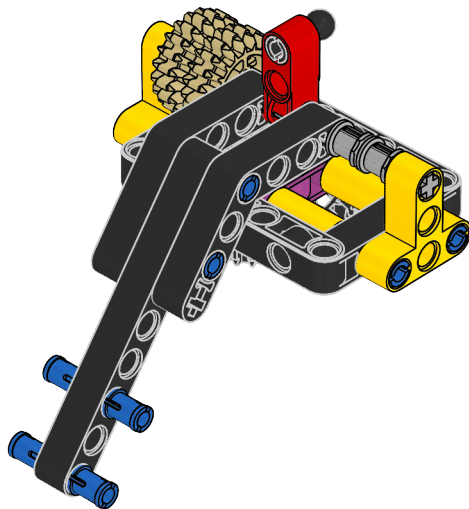

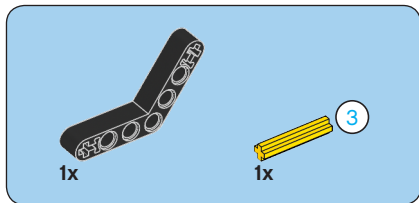

19

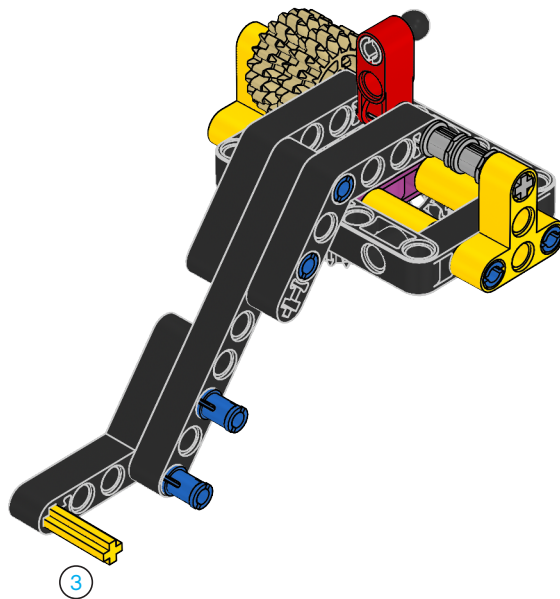

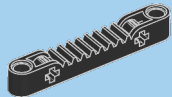

1x

20

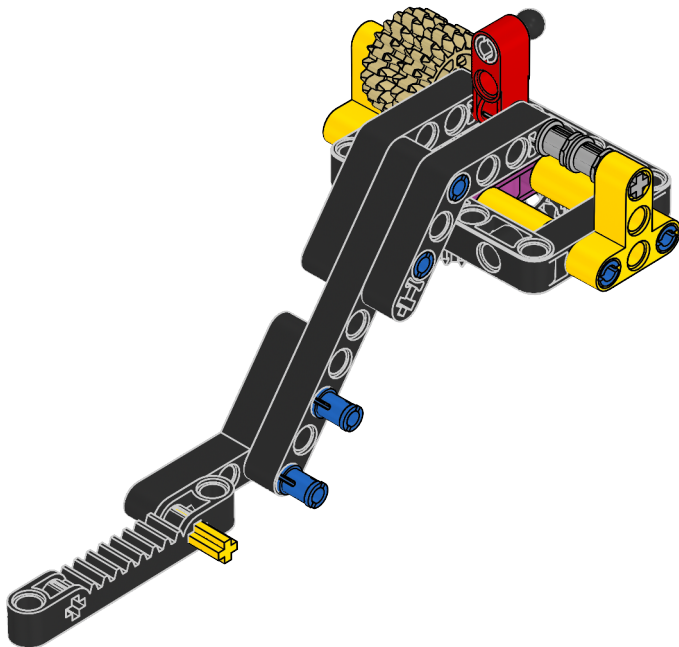

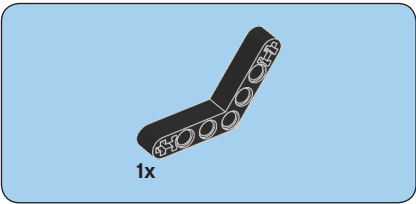

21

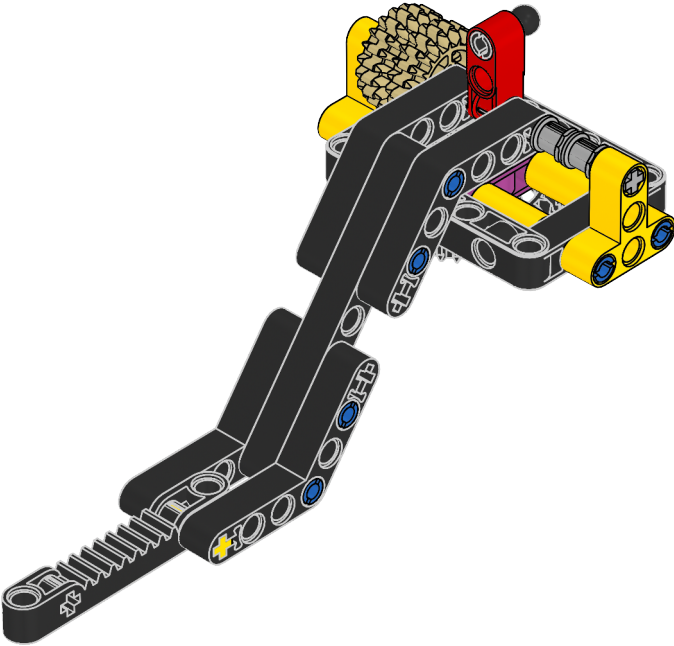

22

