

1

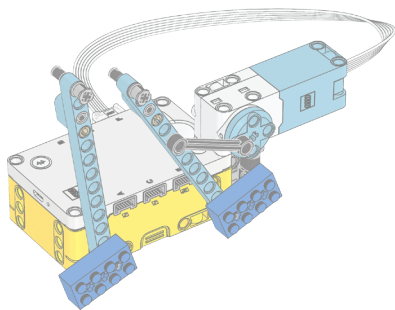

+

2

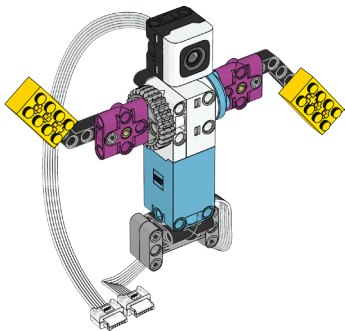

→

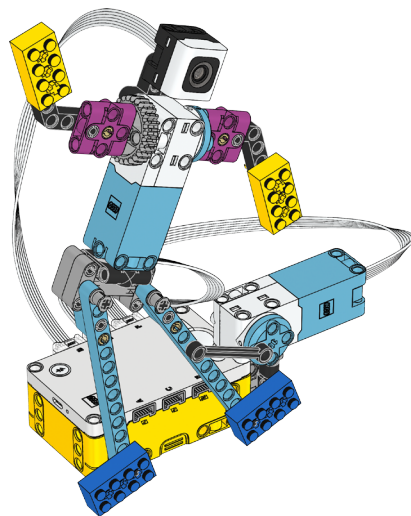

1 x



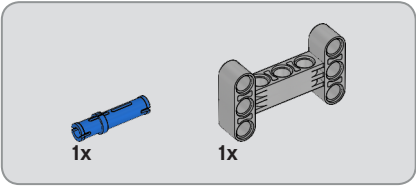
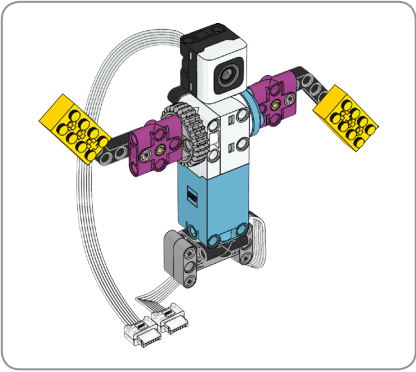

1

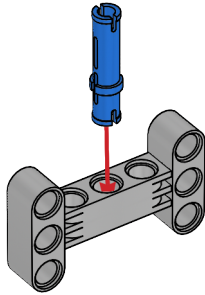



4x

2

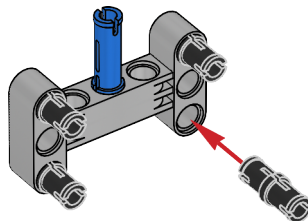

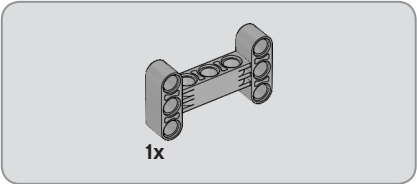

3

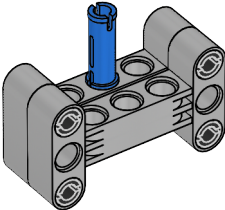



2x

4

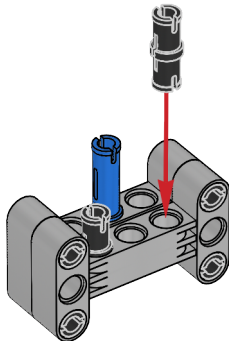

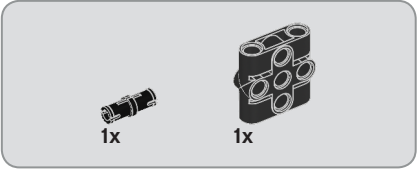

5

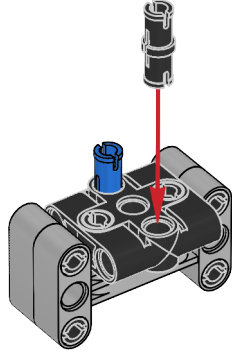

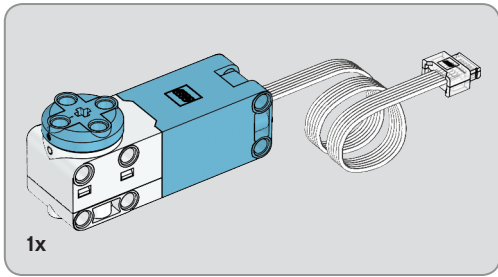

6

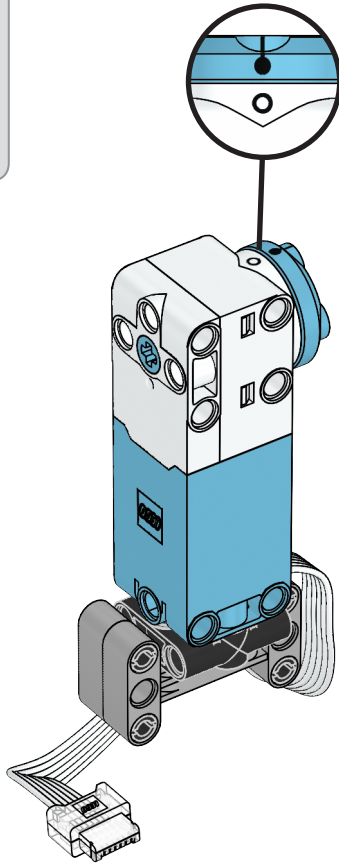





2x



1x

7

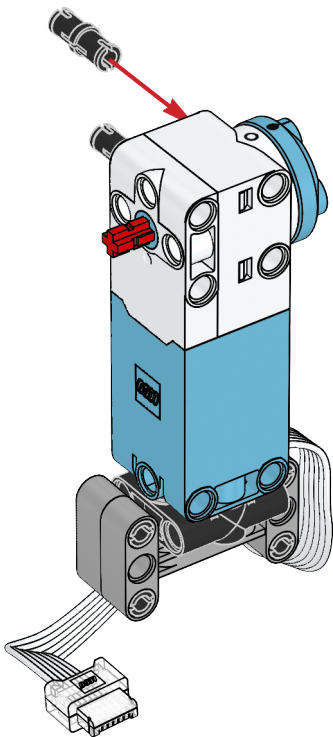

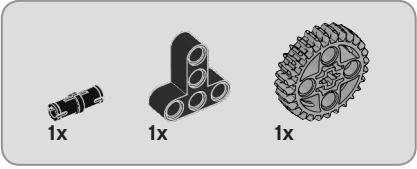

8

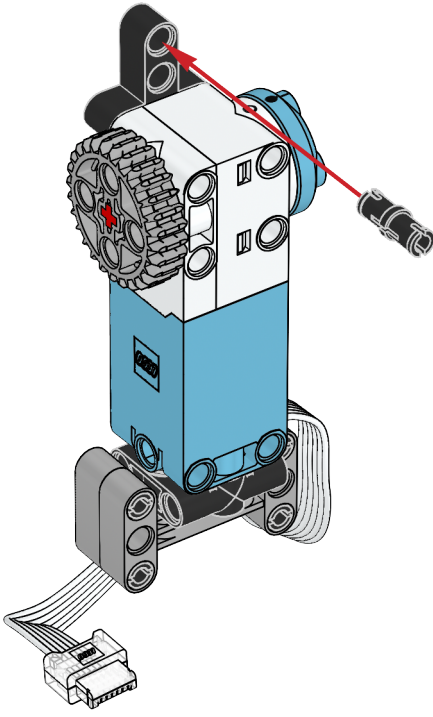

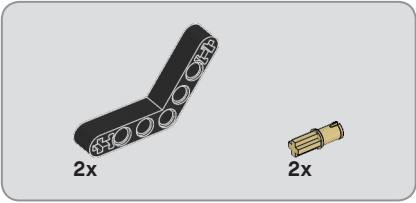
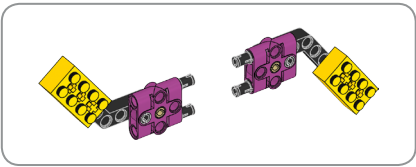

9

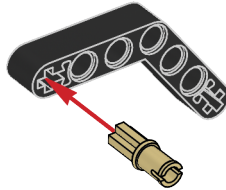
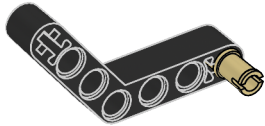

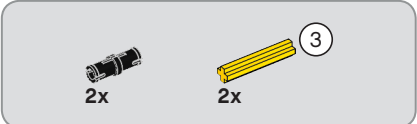

10

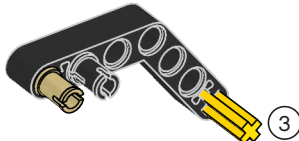

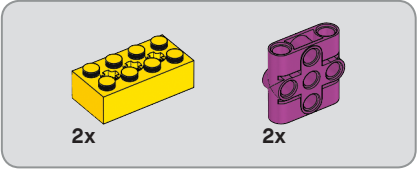

11

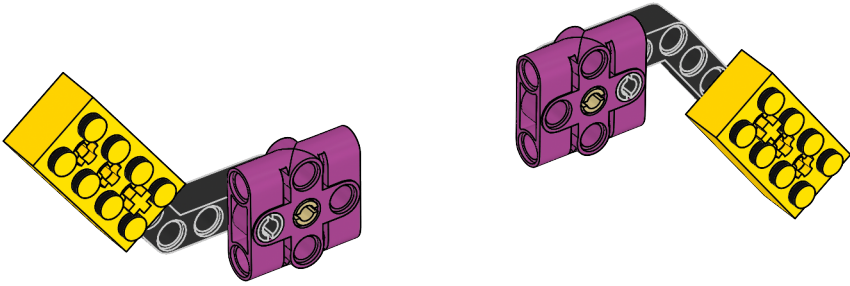



4x

12

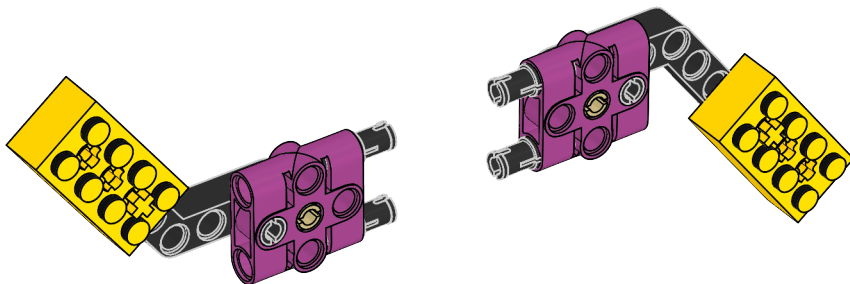

13

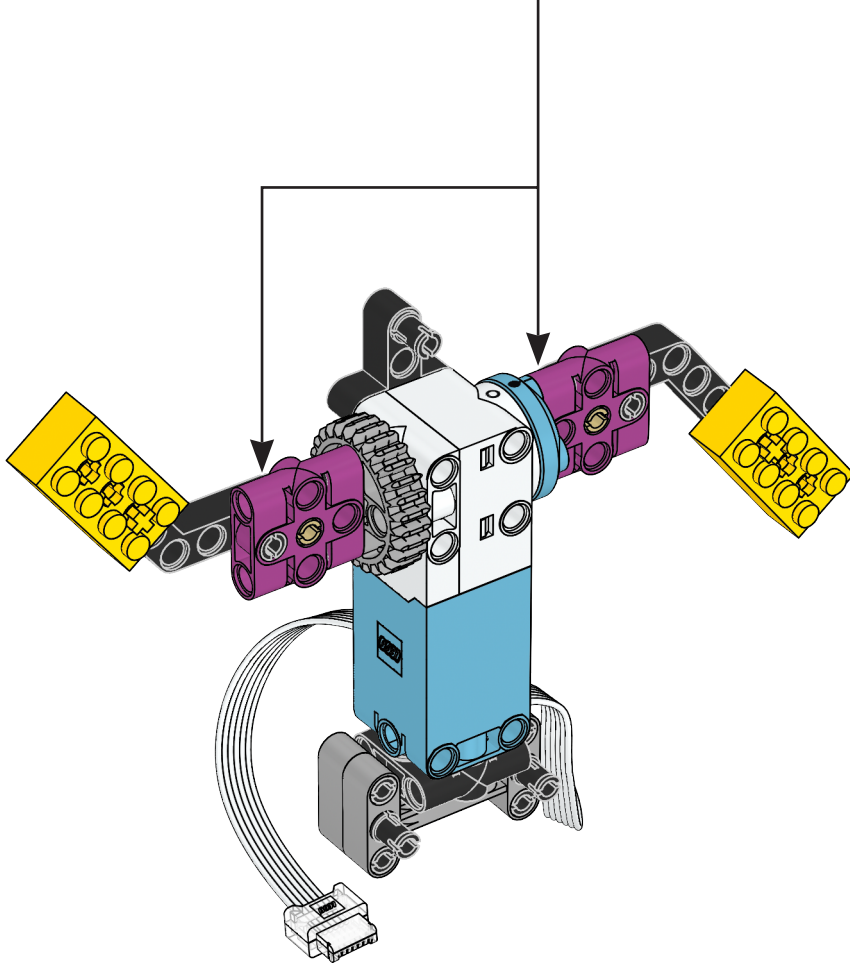

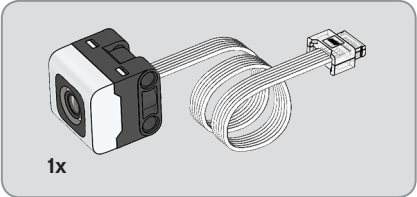

14

