

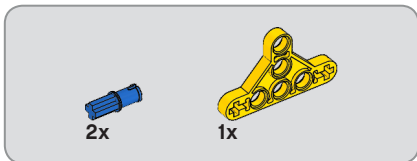

1 x

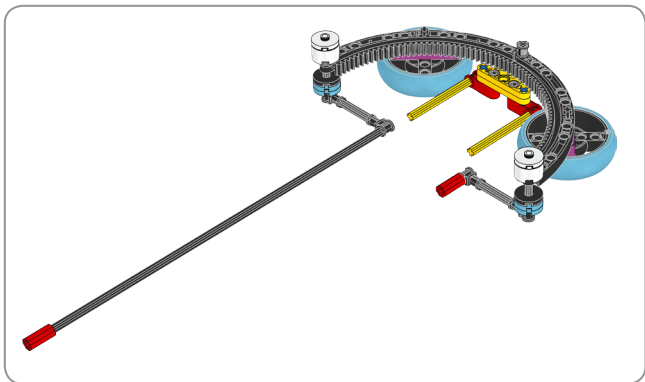

1 x



1

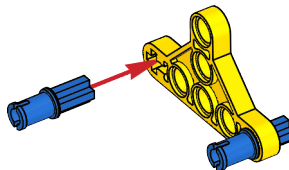

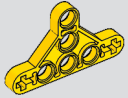

1x

2

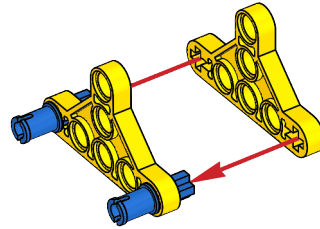



2x

3

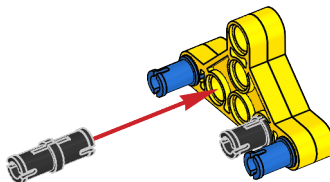



2x

4

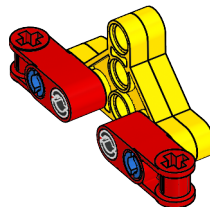

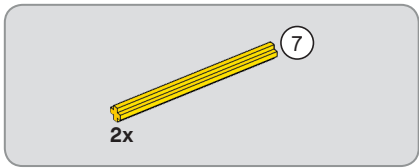

5

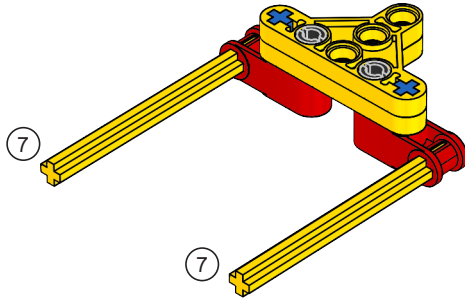



1x

6

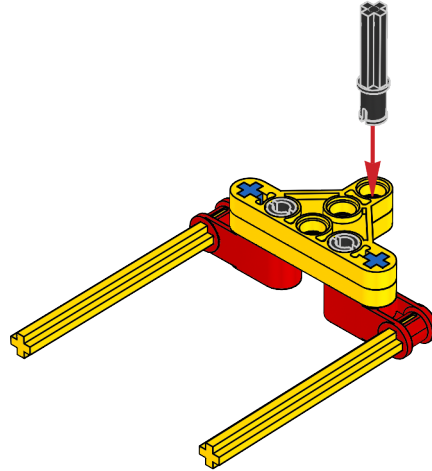



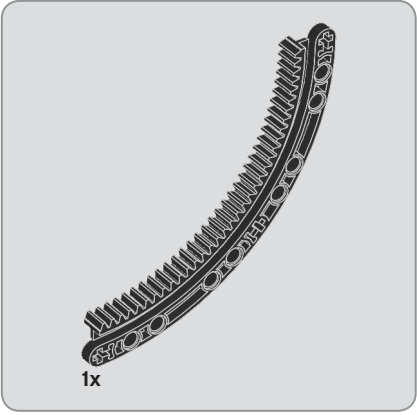

7

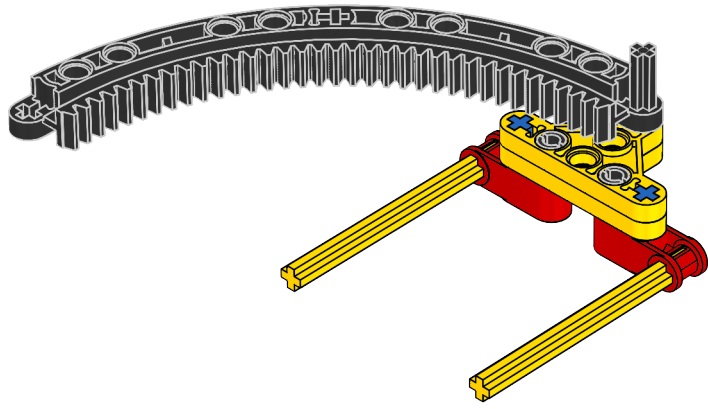

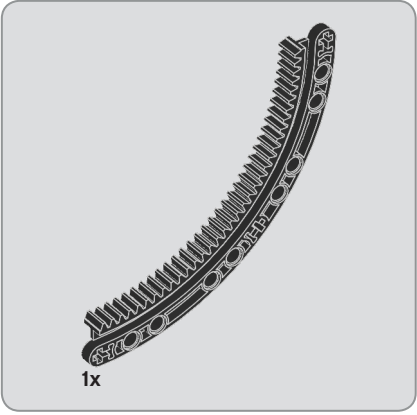

8

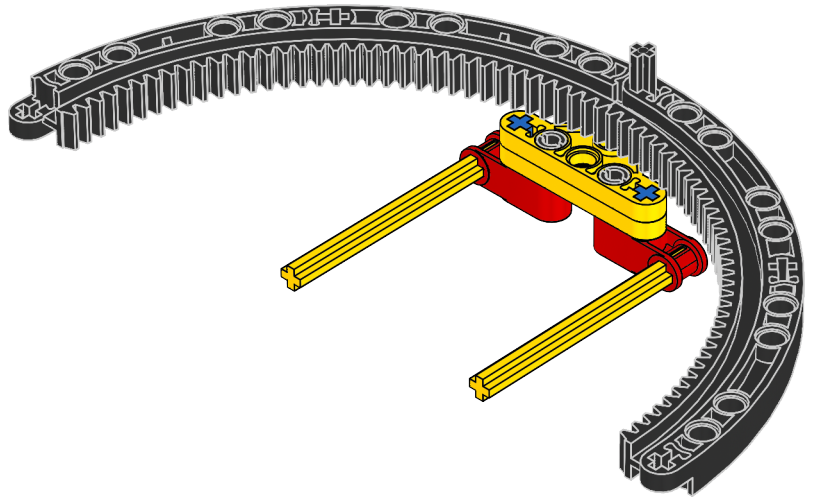



1x

9

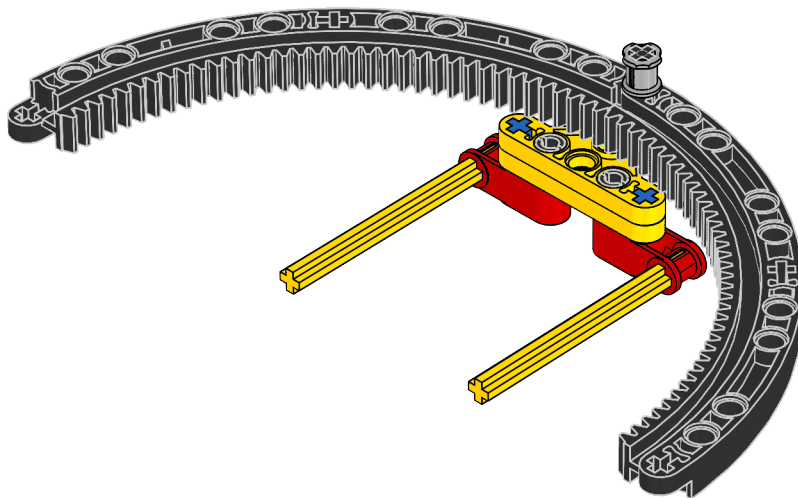

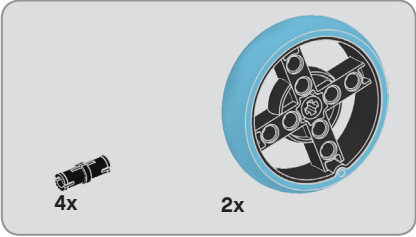
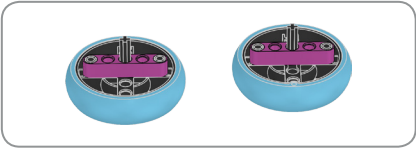

10

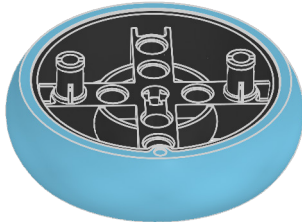
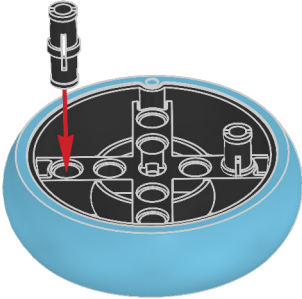

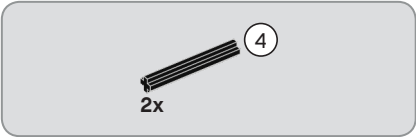

11

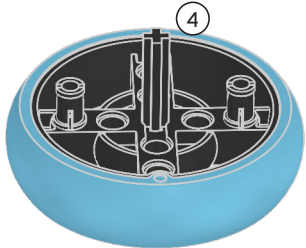
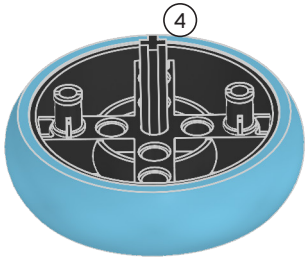

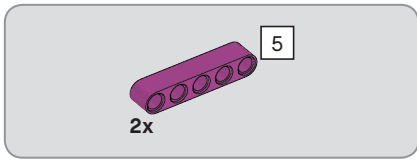

12

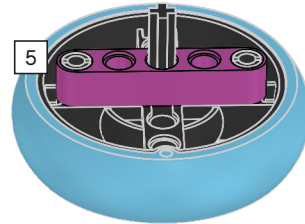
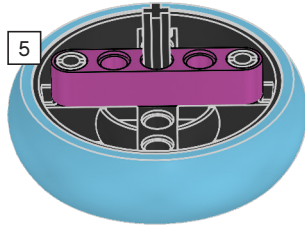

13

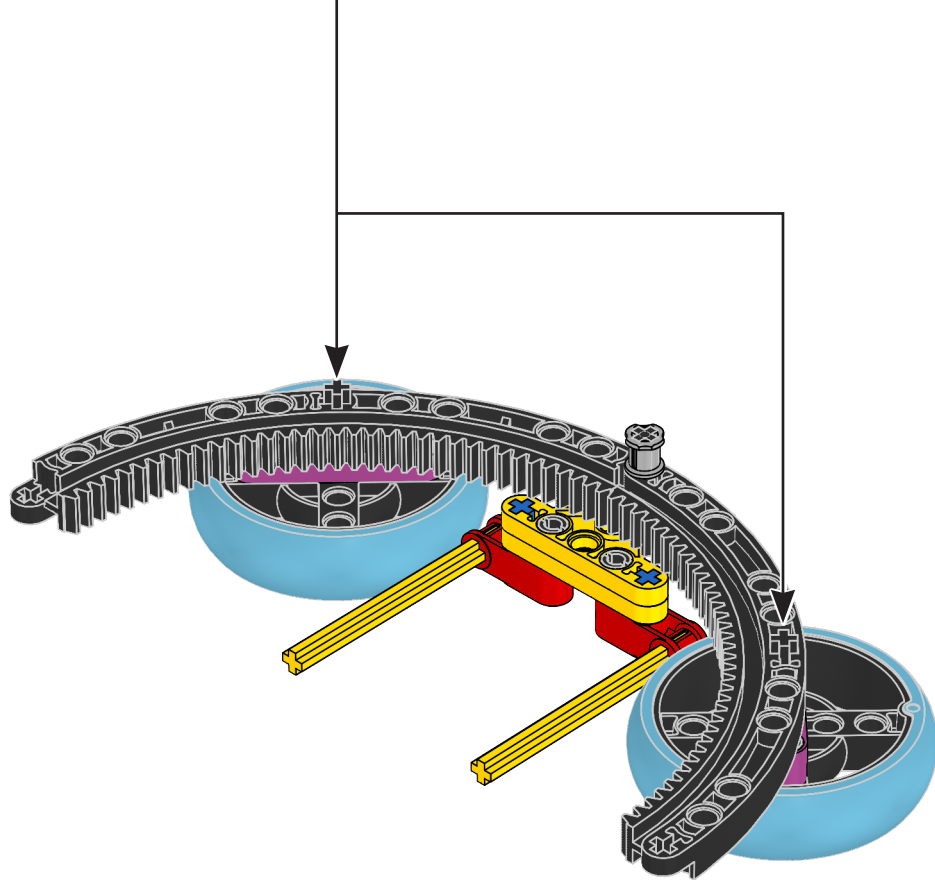

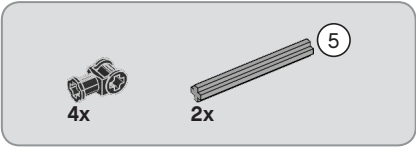
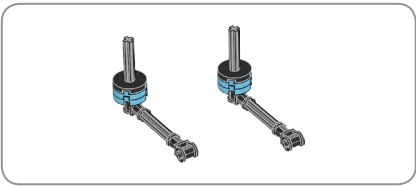

14

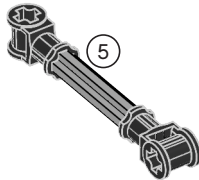
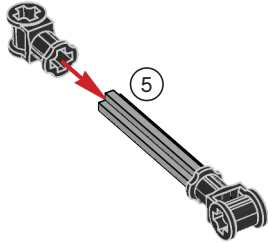



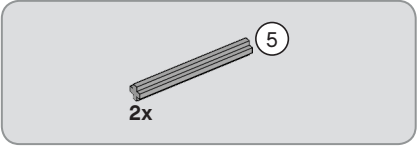

15

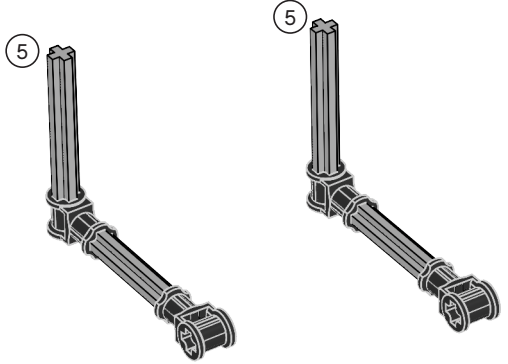

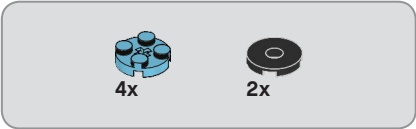

16

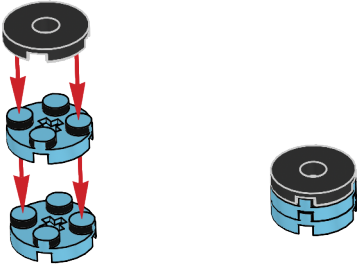

17

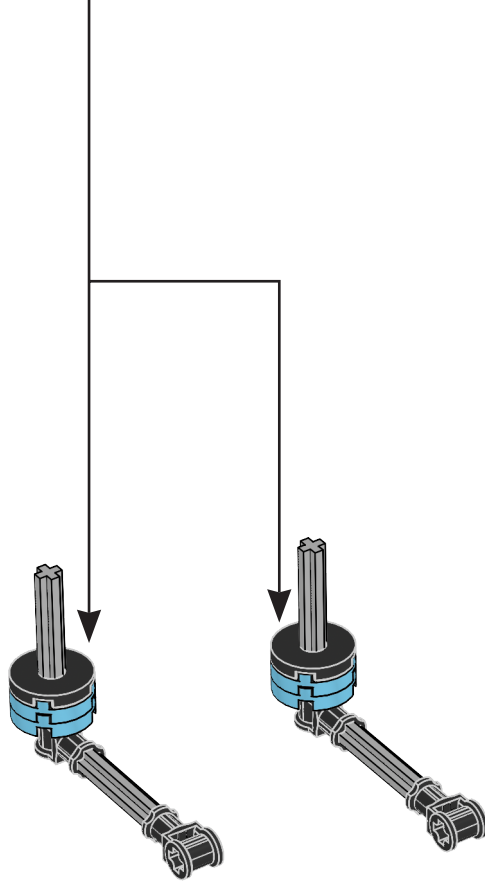

18

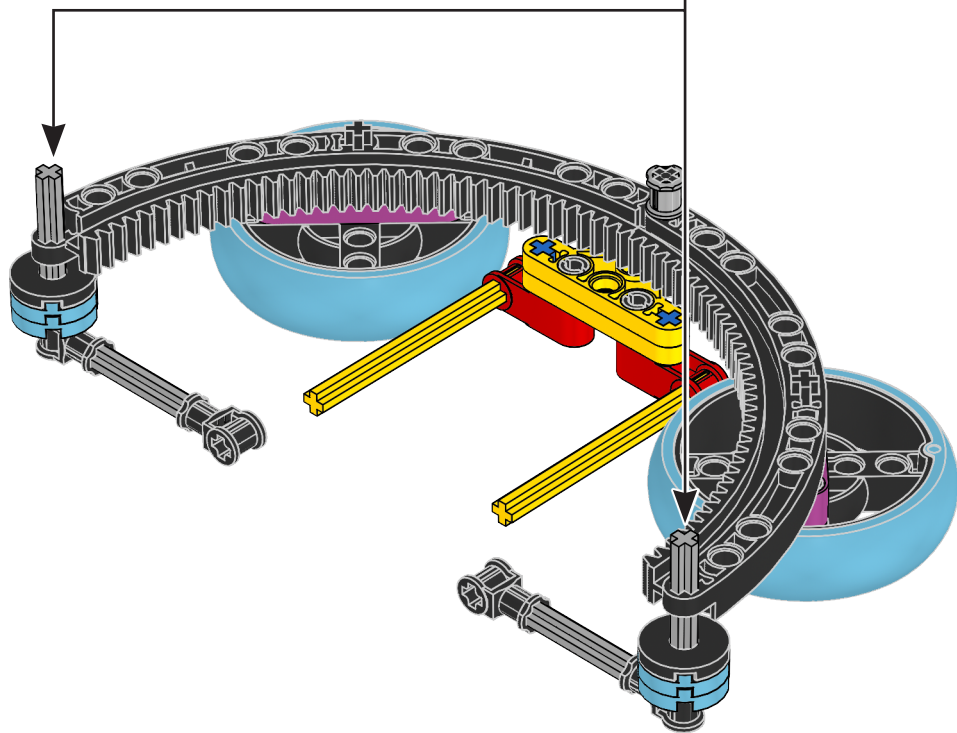

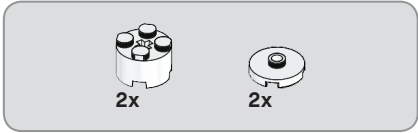
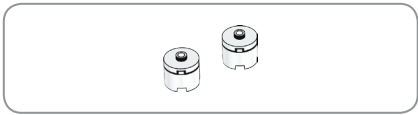

19

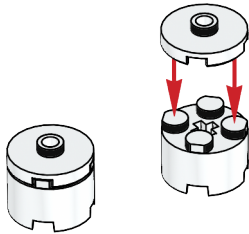

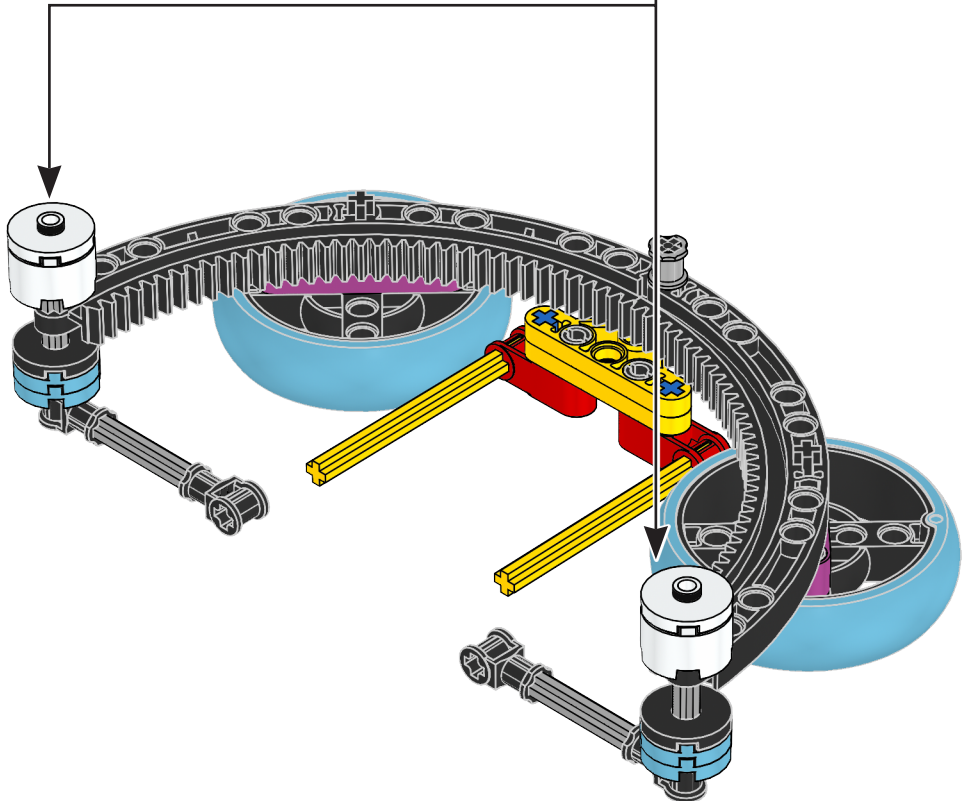

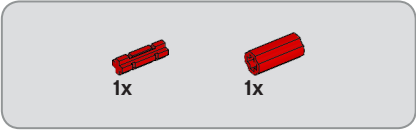
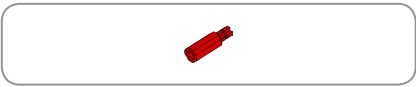

21

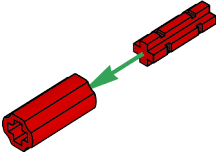

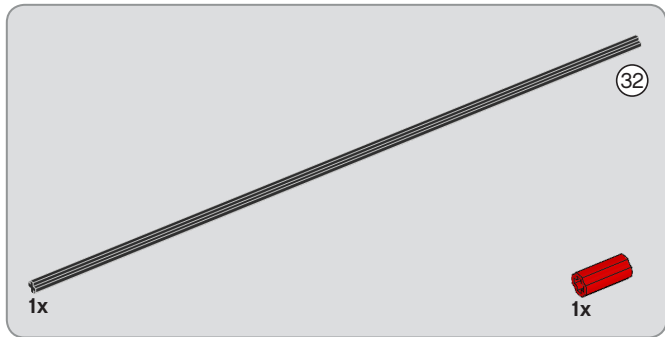

22

