

1

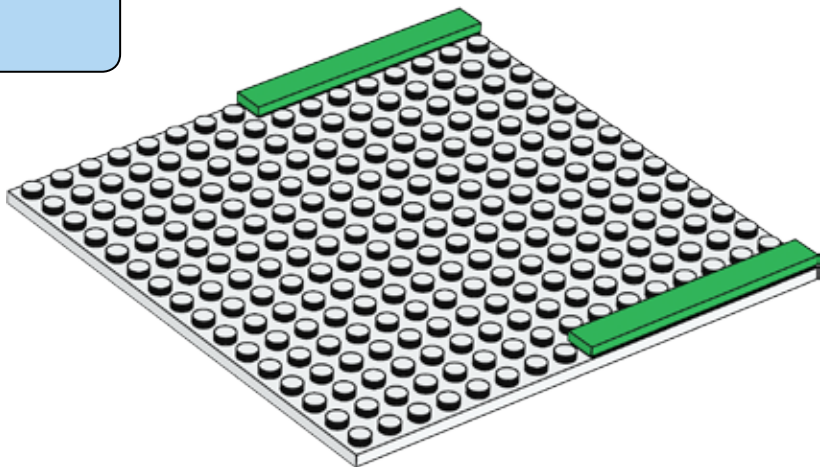



2x

2

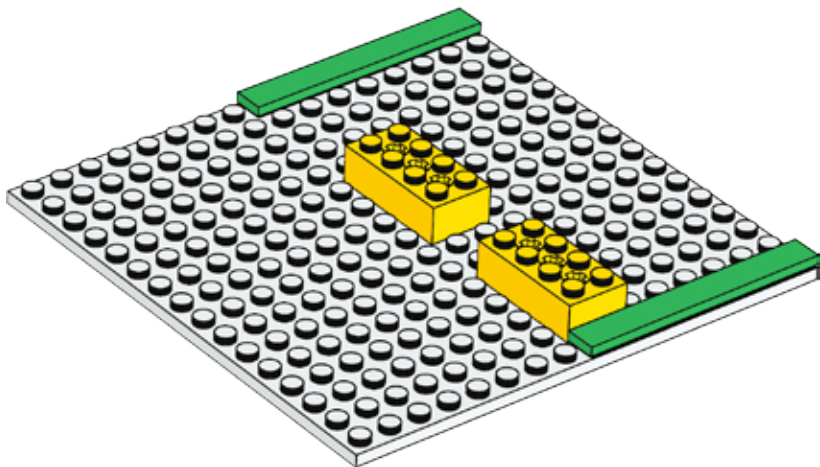



2x

3

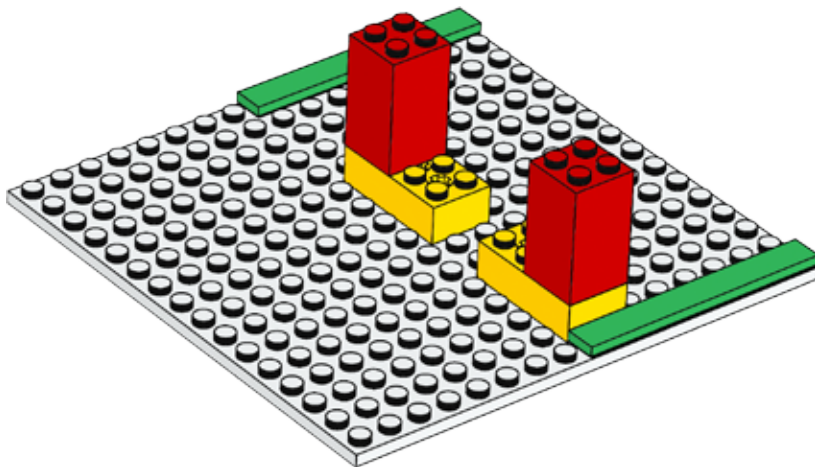



2x

4

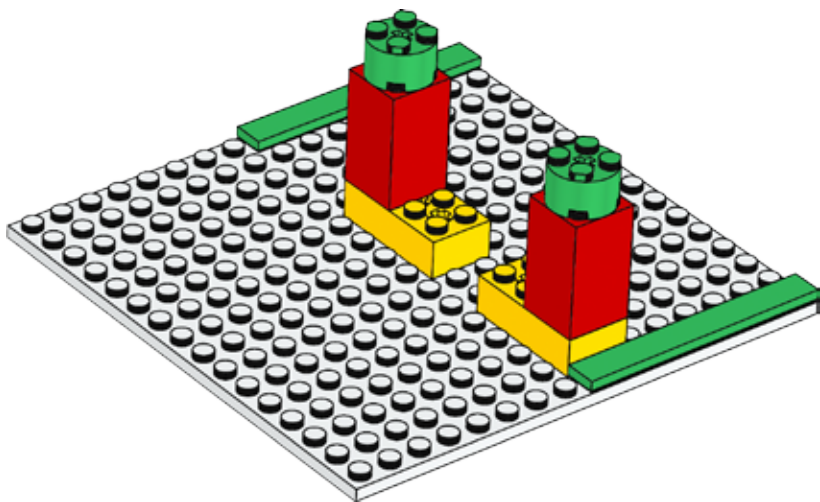

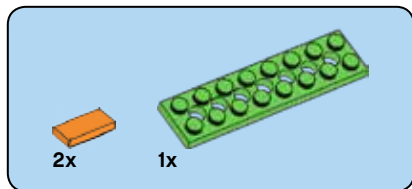

5

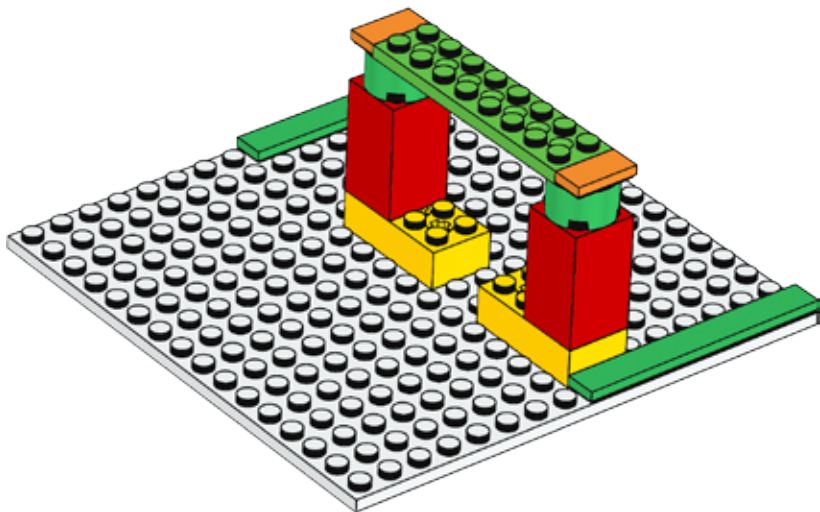



4x

6

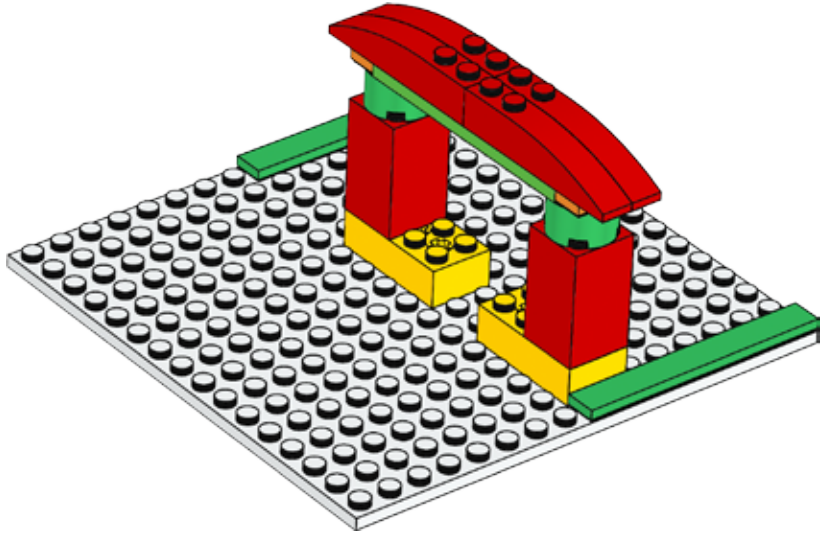



1x

7

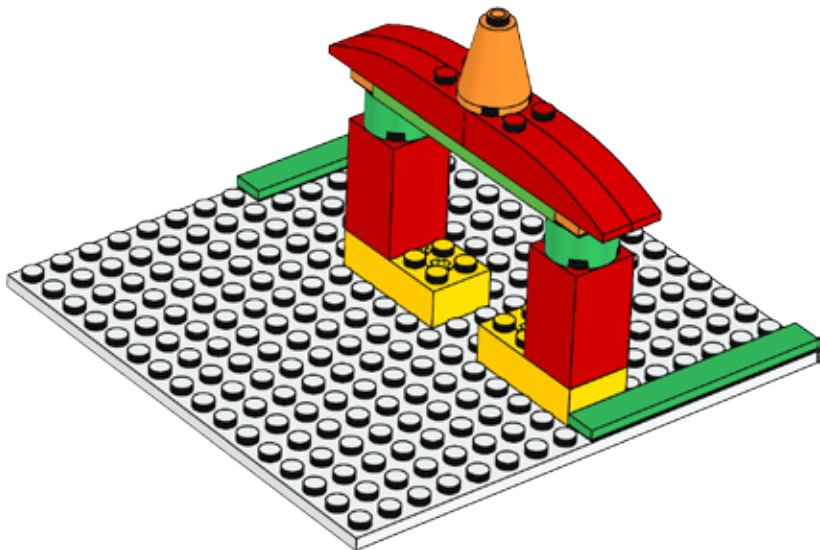

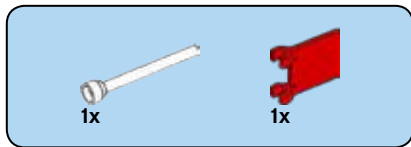

8

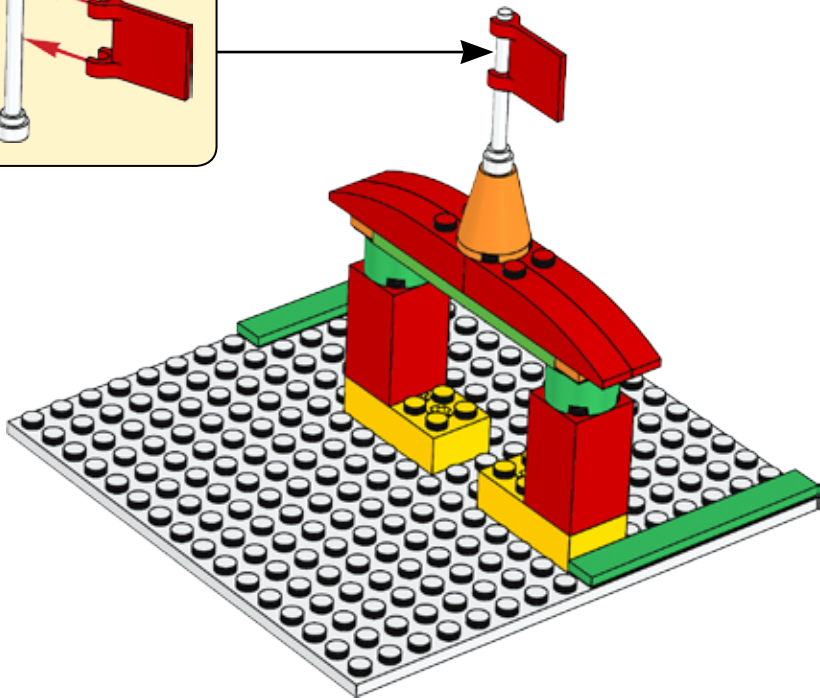
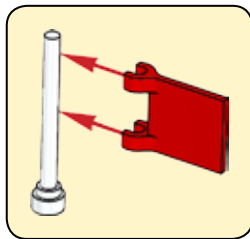



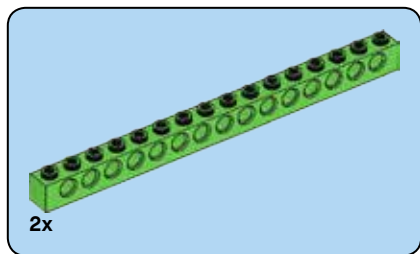

9

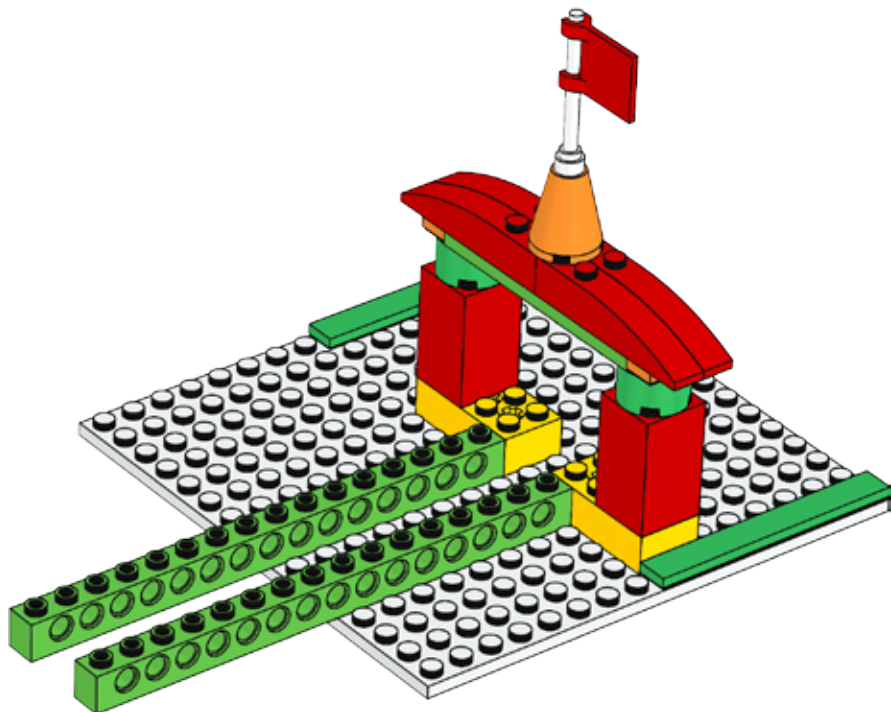

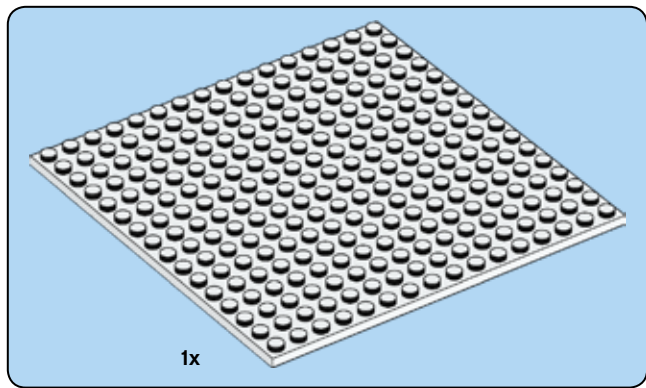

10

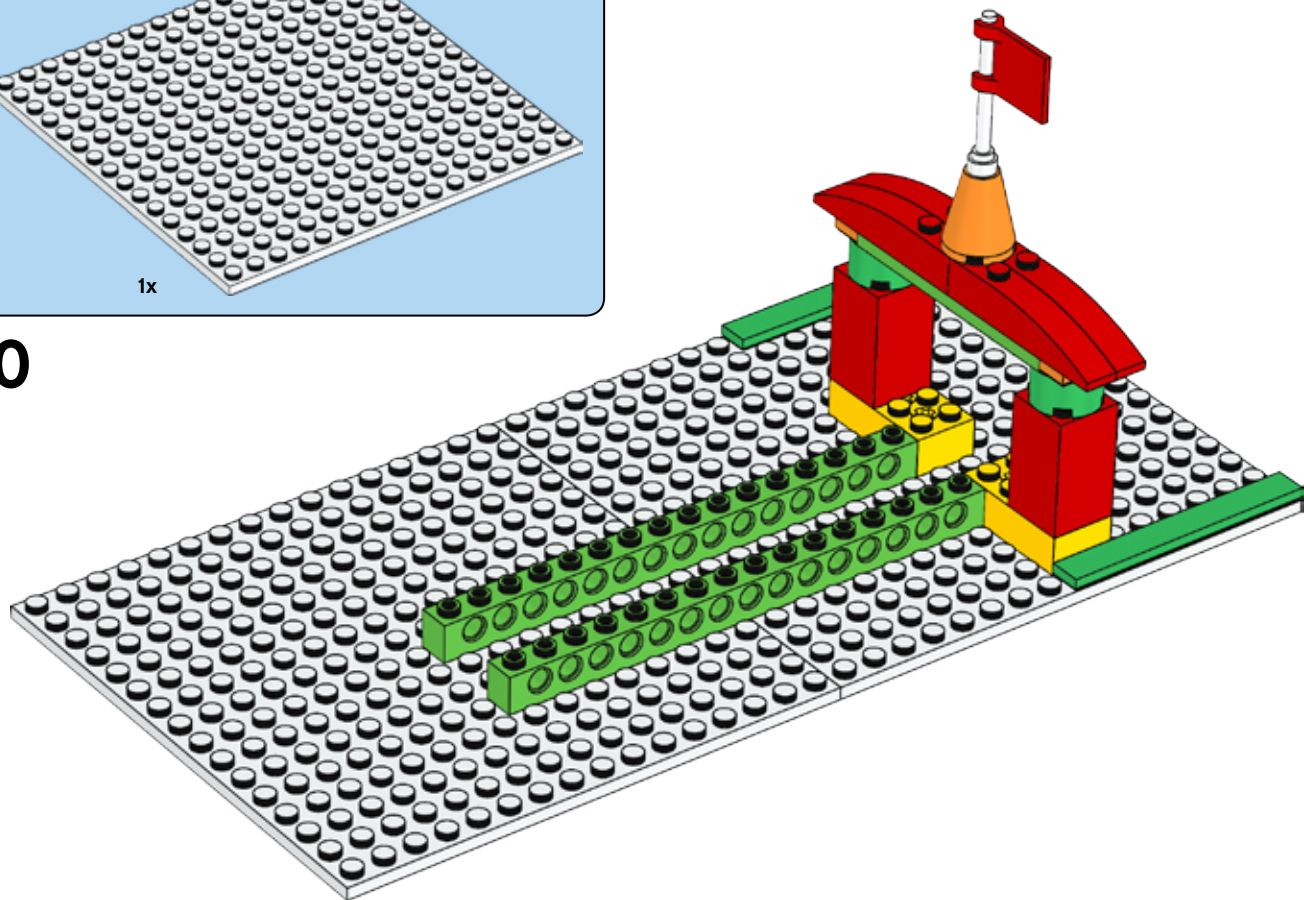

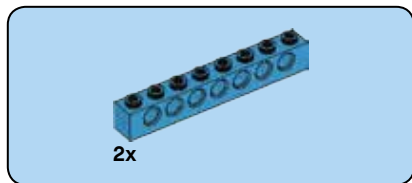

11

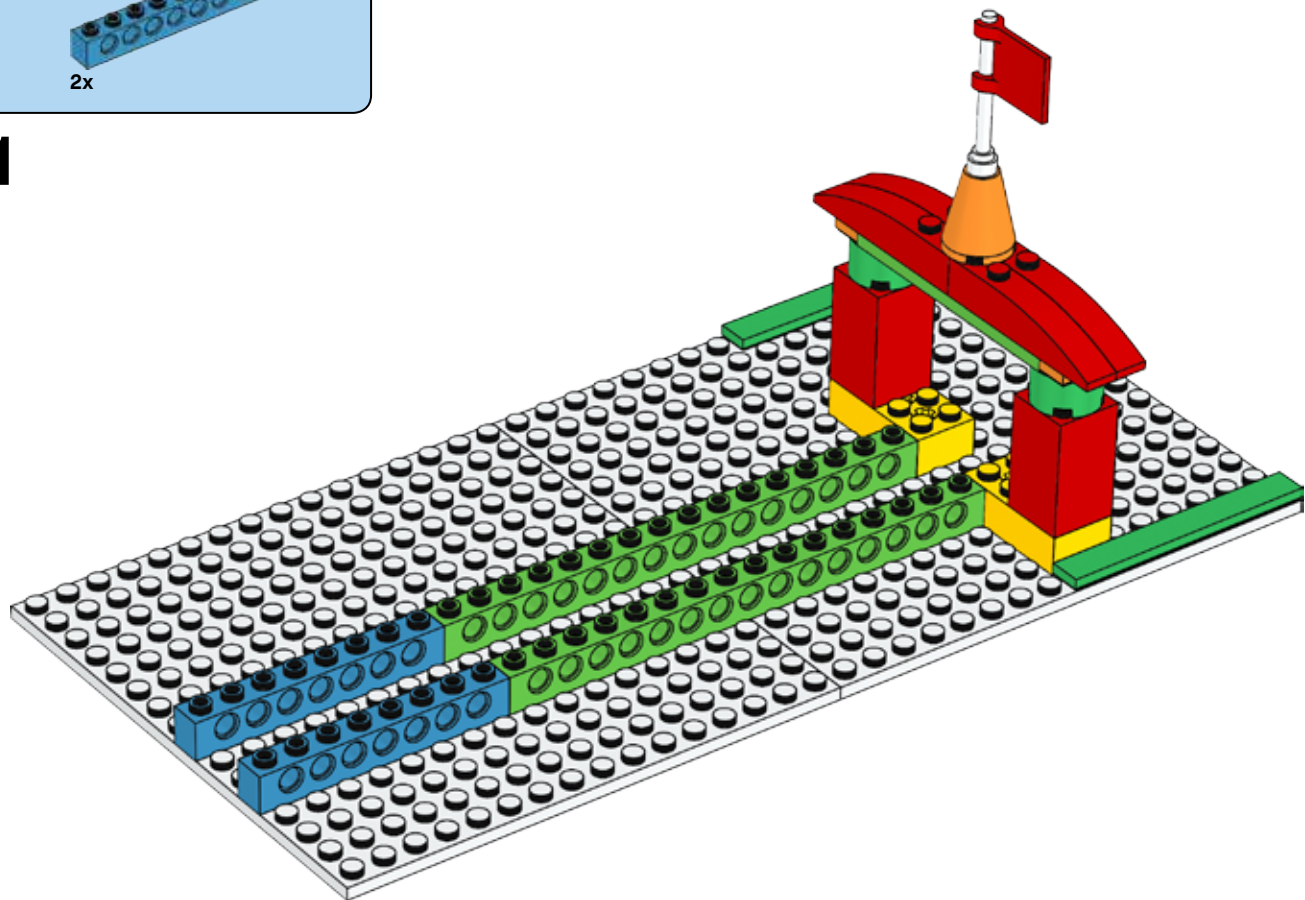



2x

12

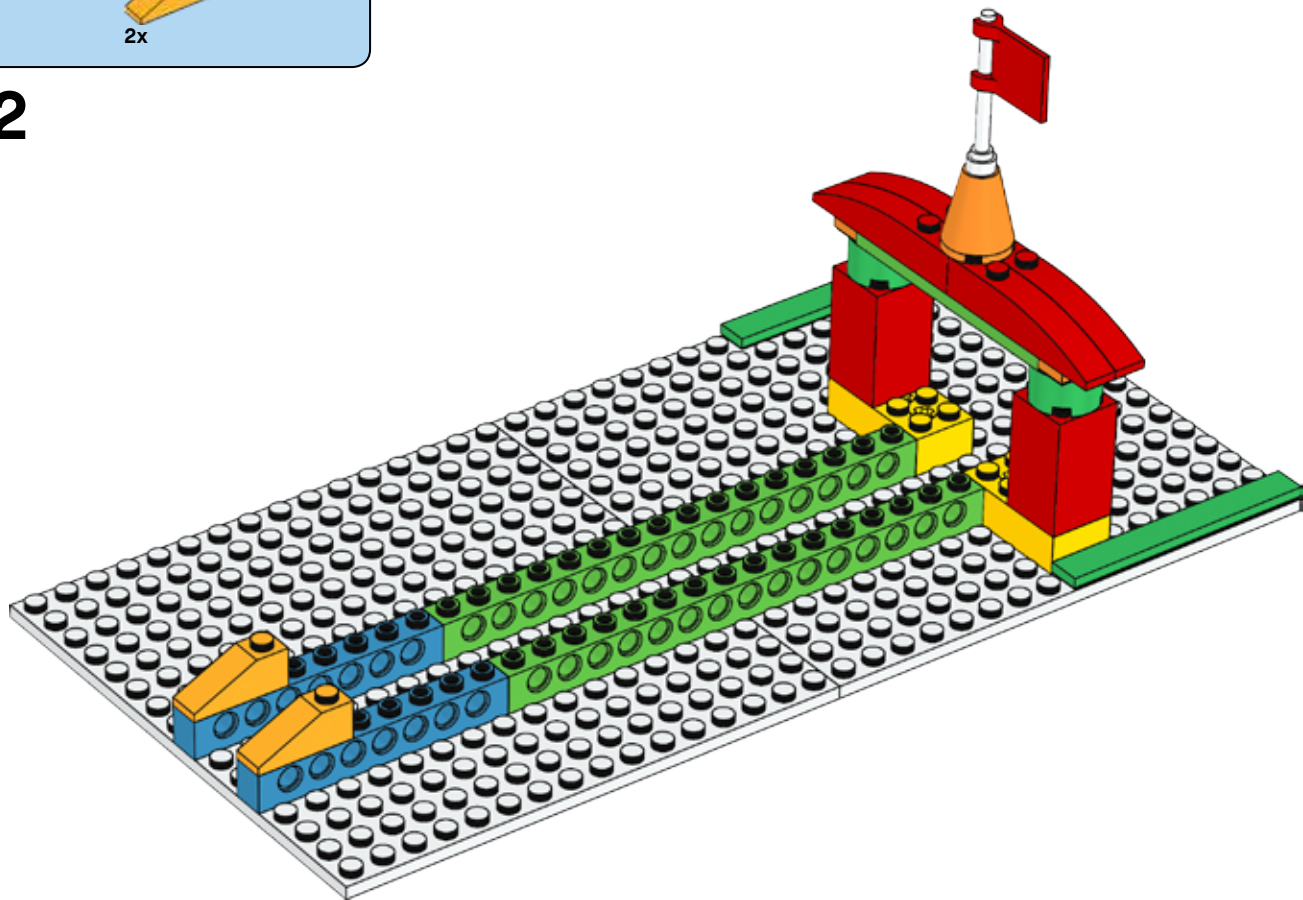

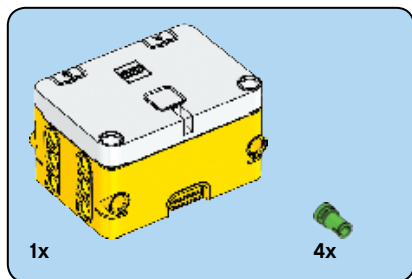

13

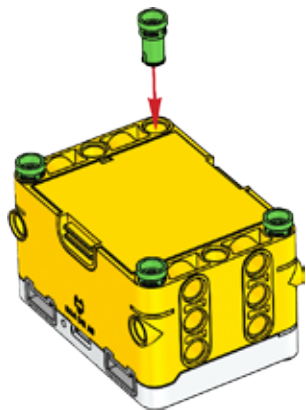

14

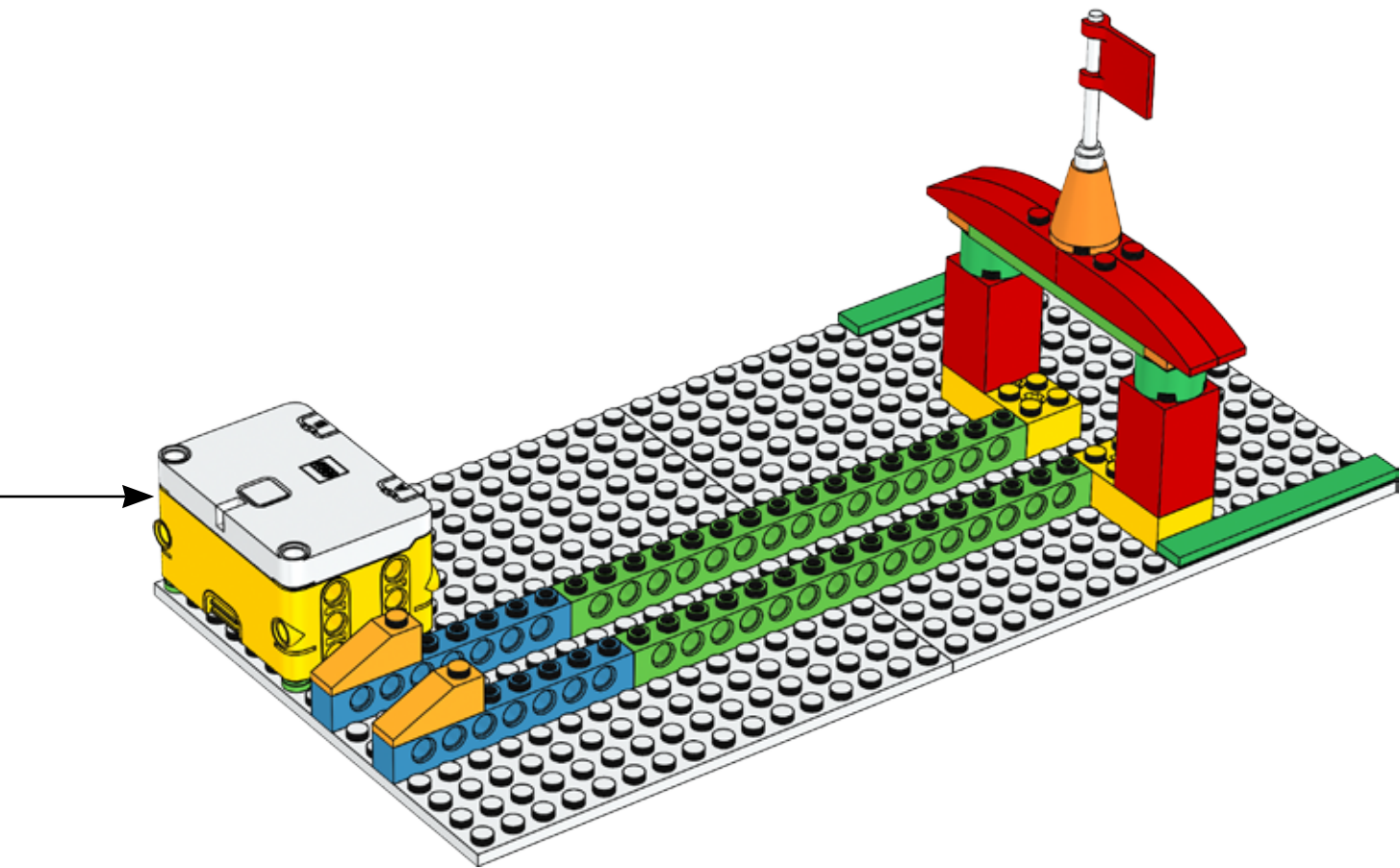

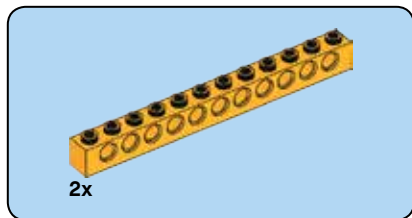

15

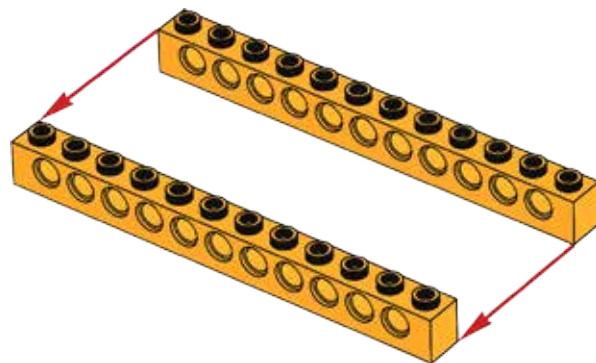

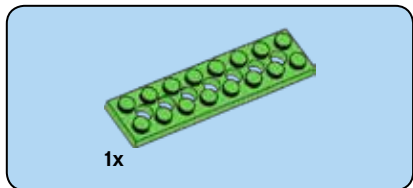

16

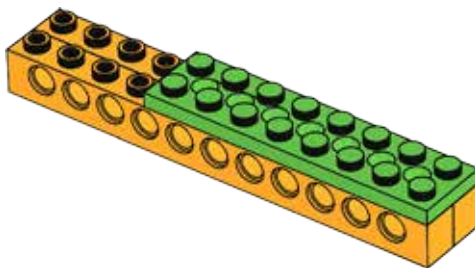





1x

17

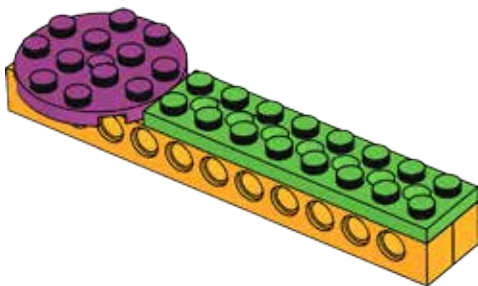



2x

18

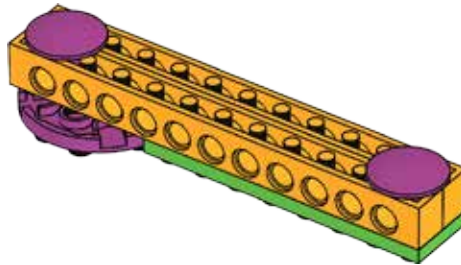
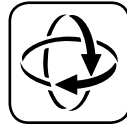

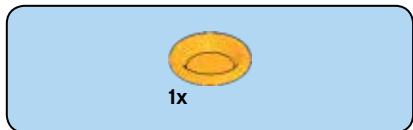

19

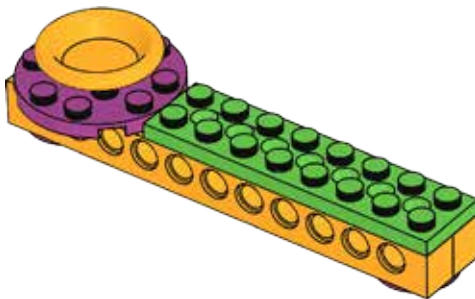

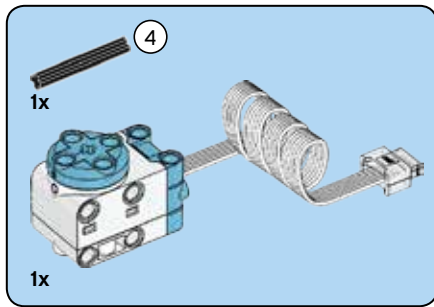

20

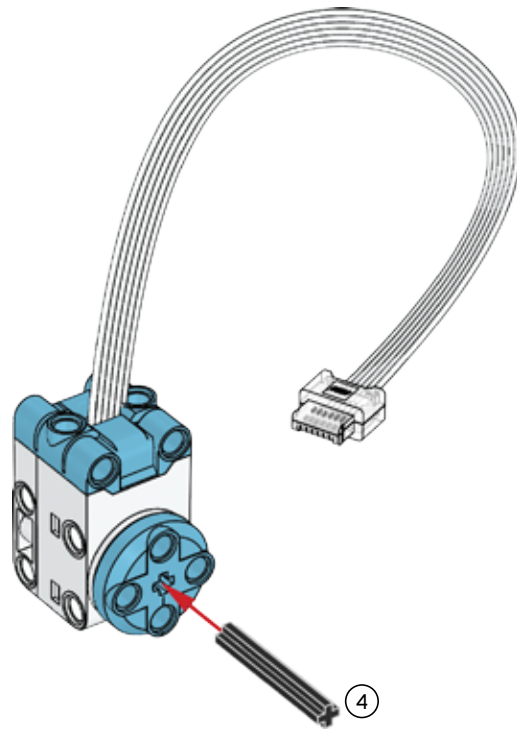

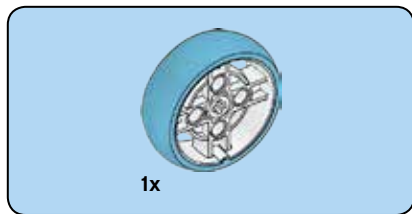

21

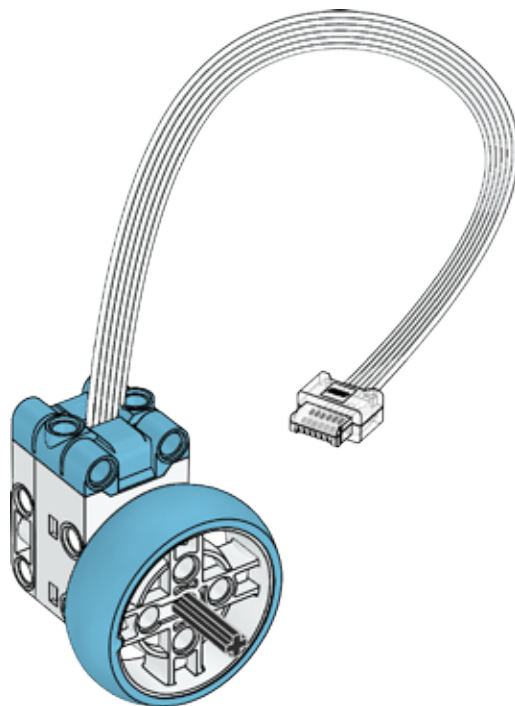

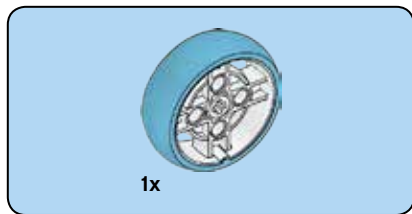

22

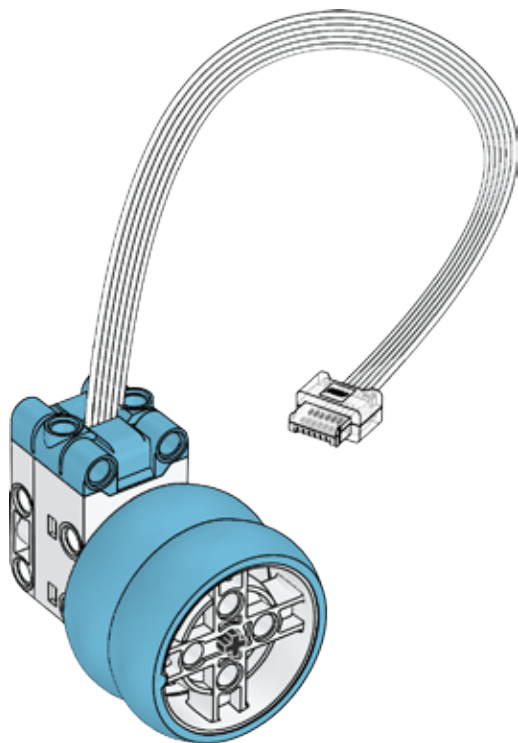



2x

23

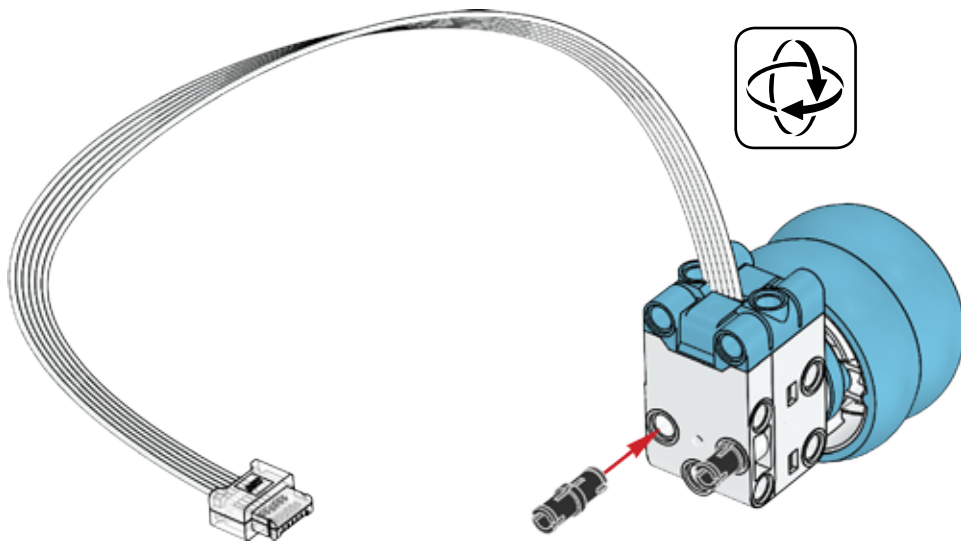



1x

24

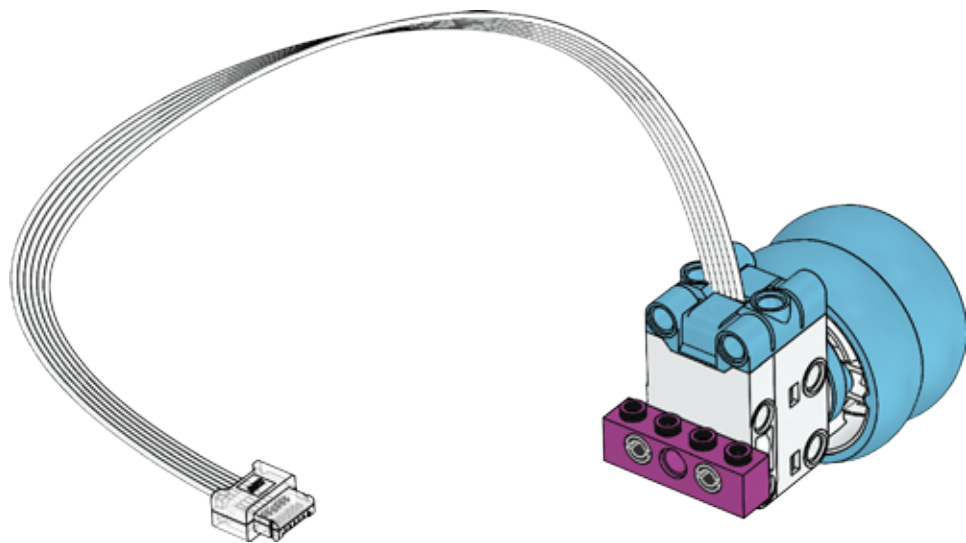



25

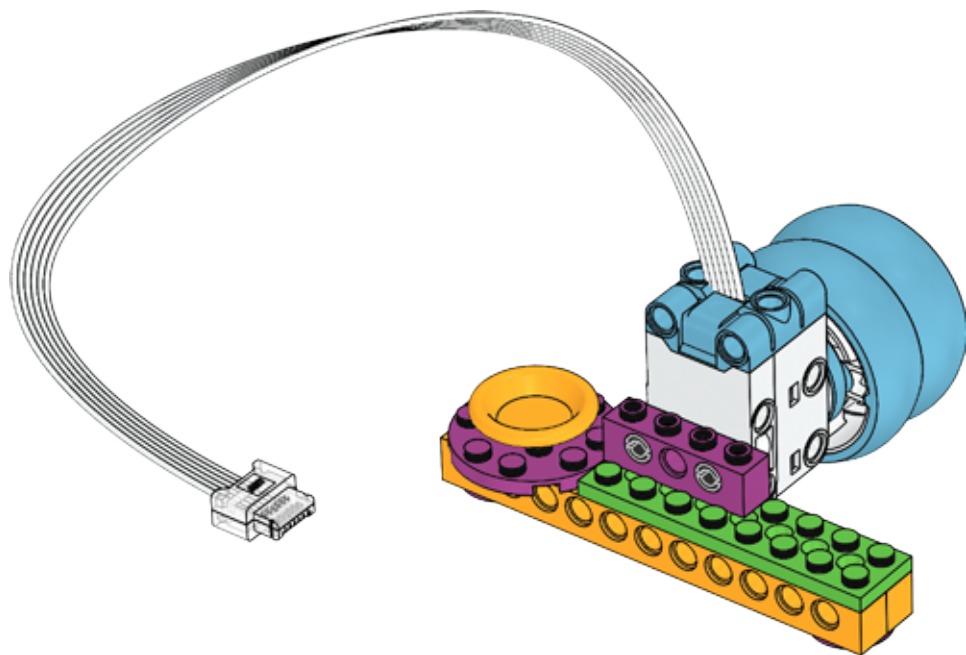

26

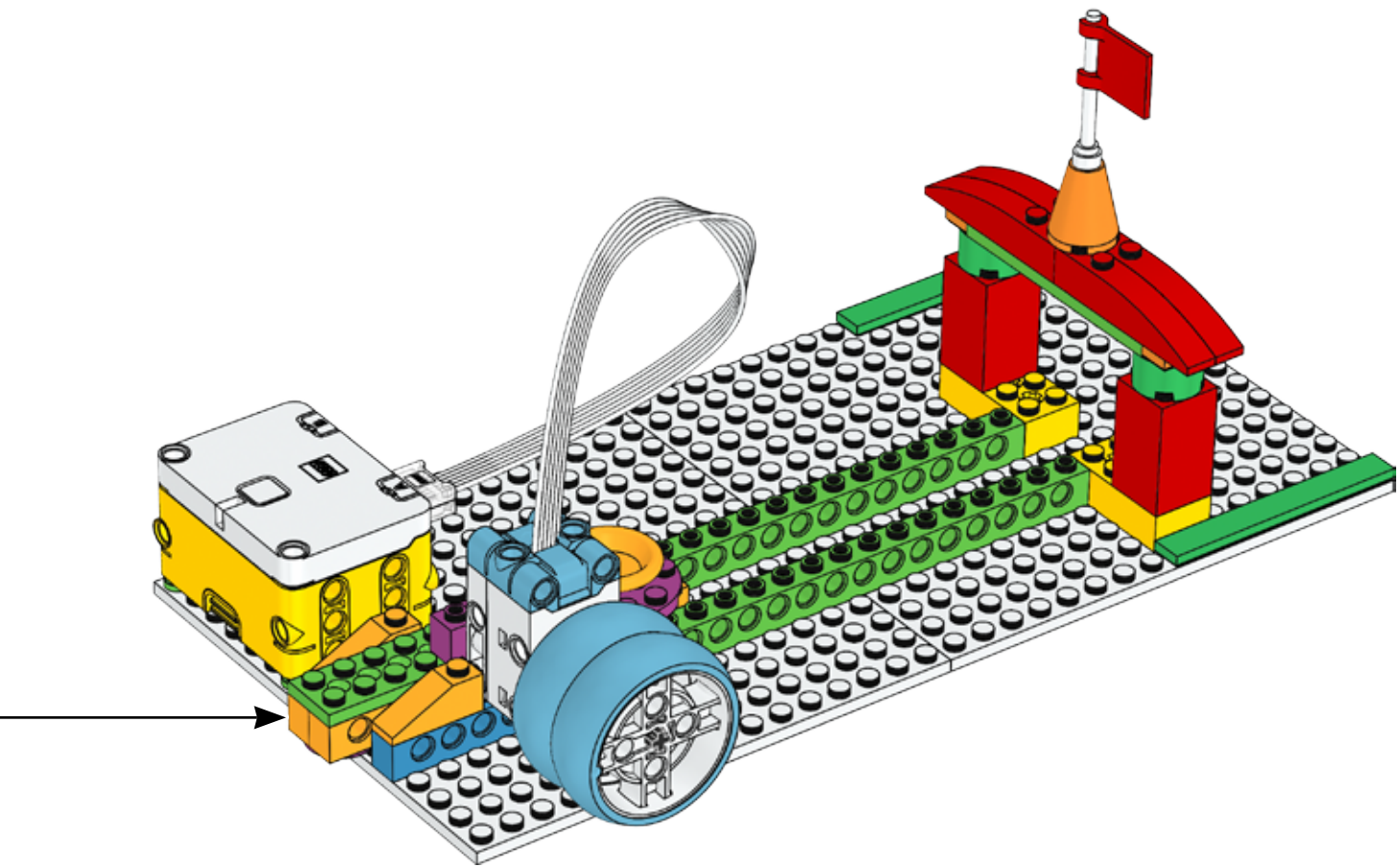

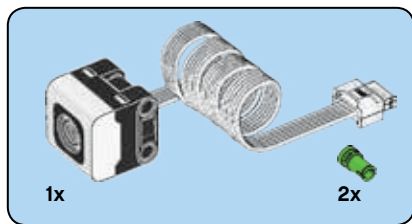

27

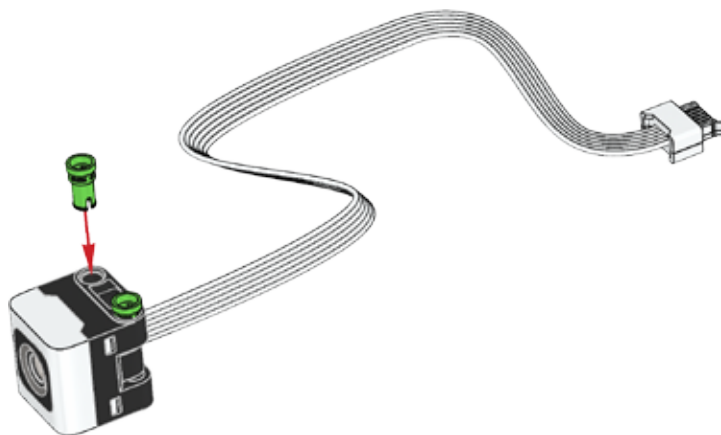

28

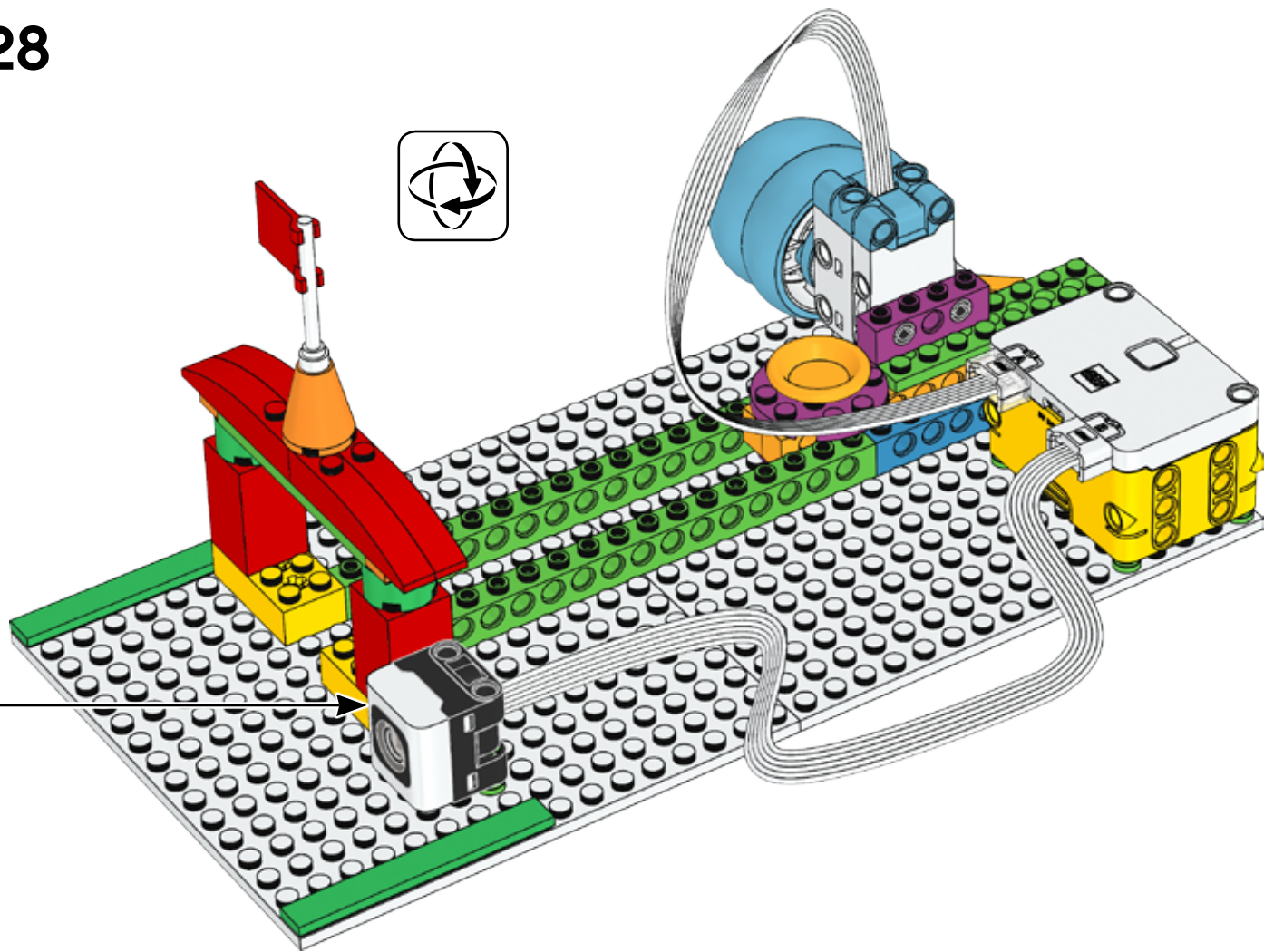



2x



1x

# 29

1



2



30

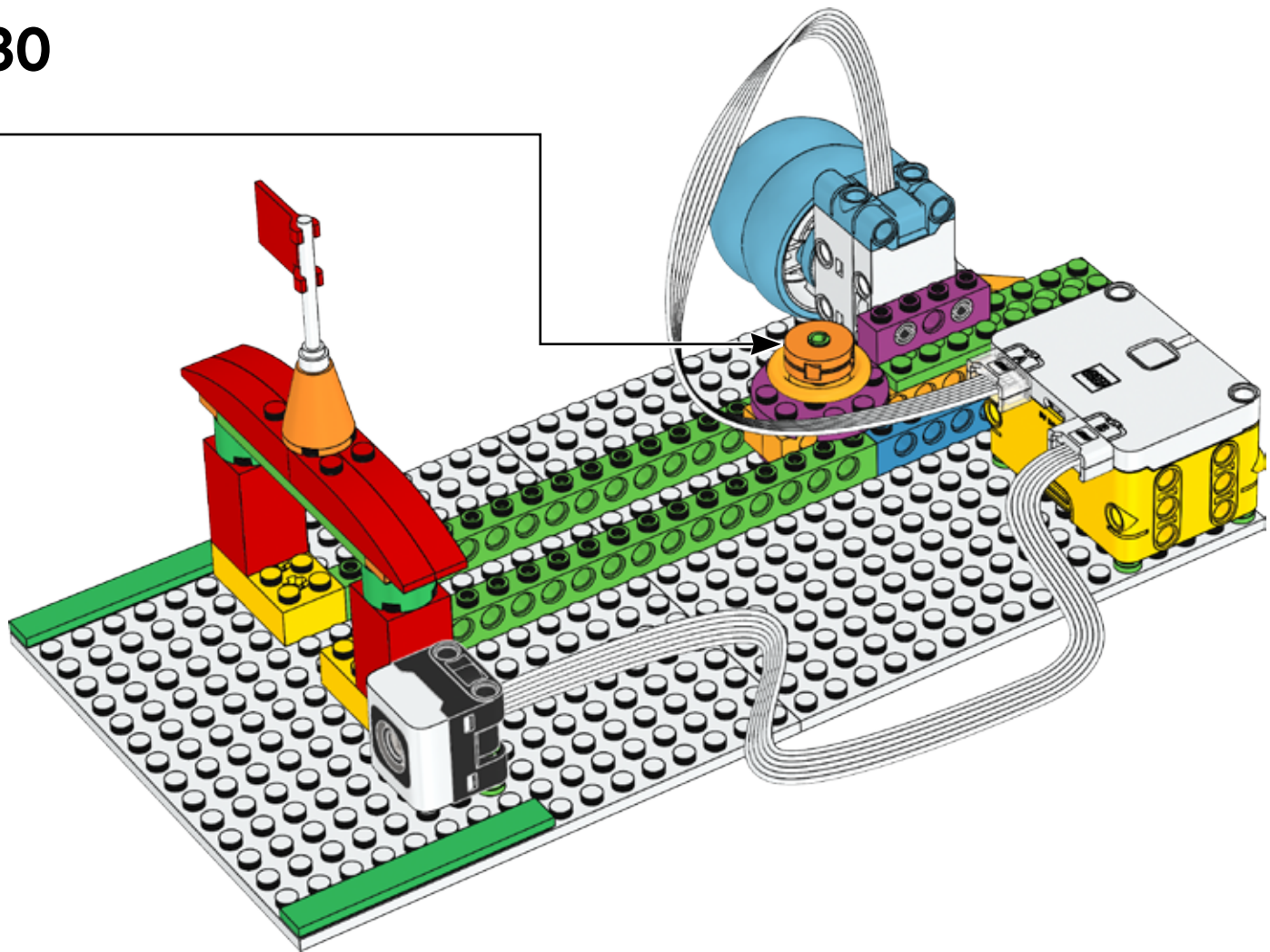

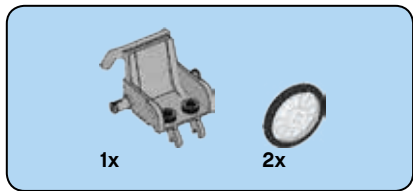

**31**

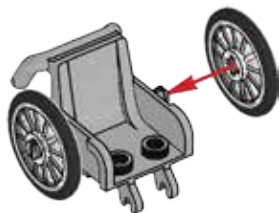



1x

32





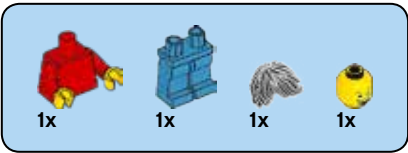

33

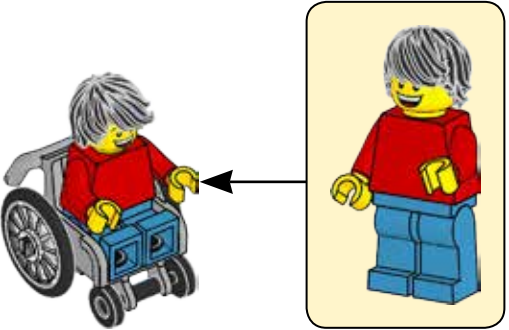

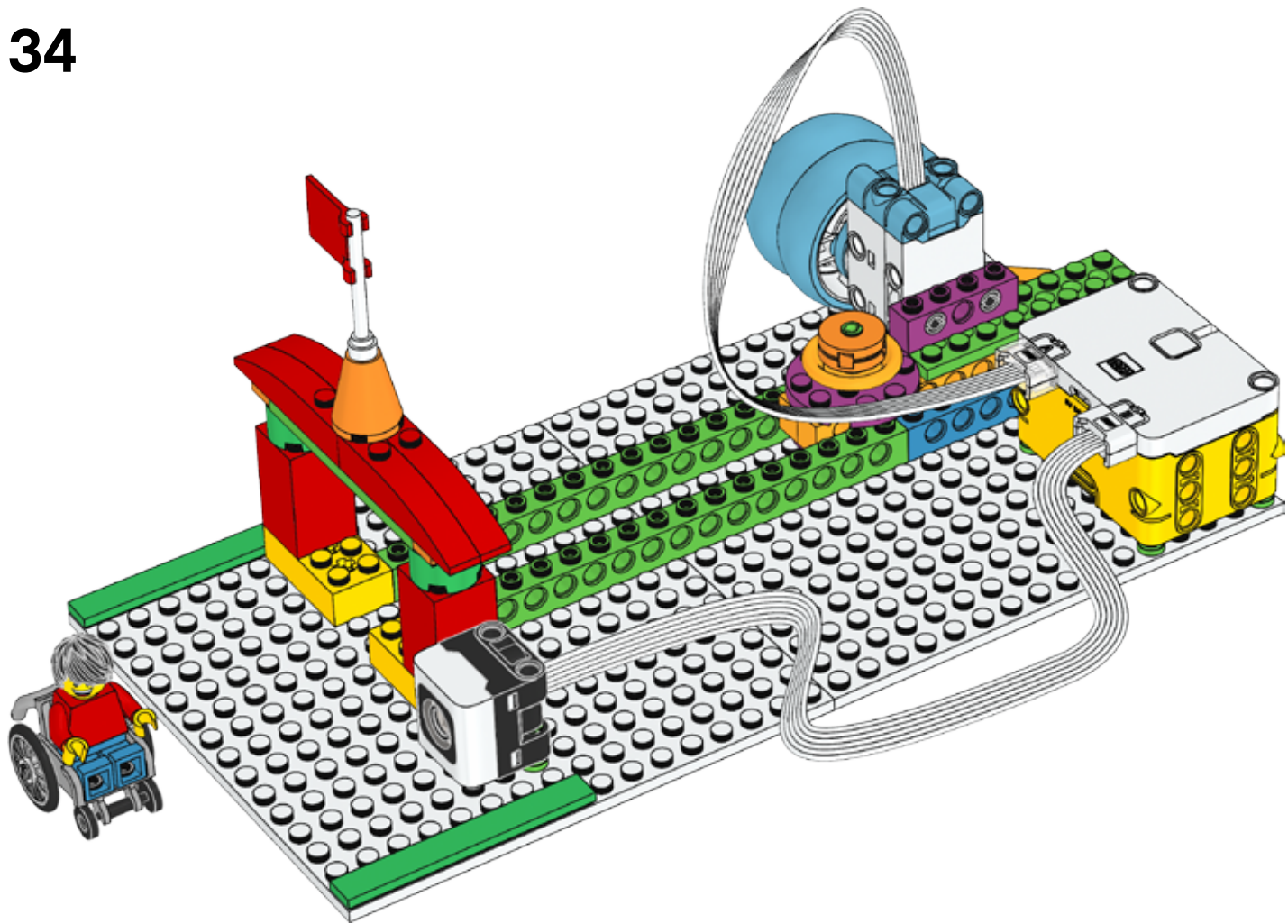

1x

35

