

1

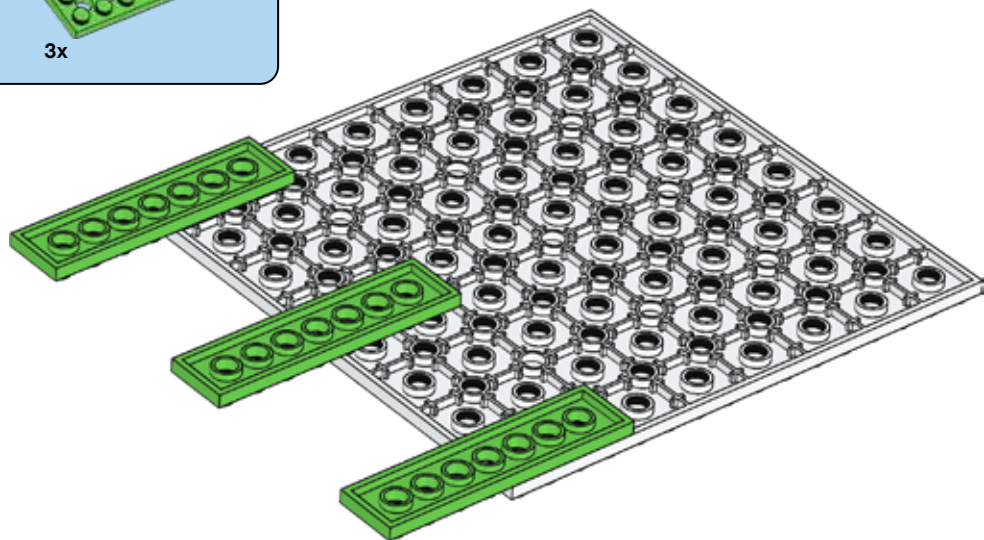

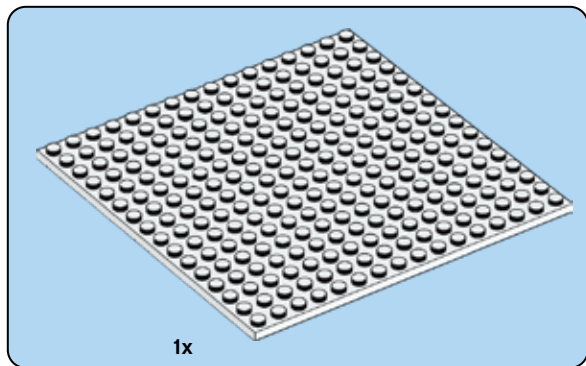

2

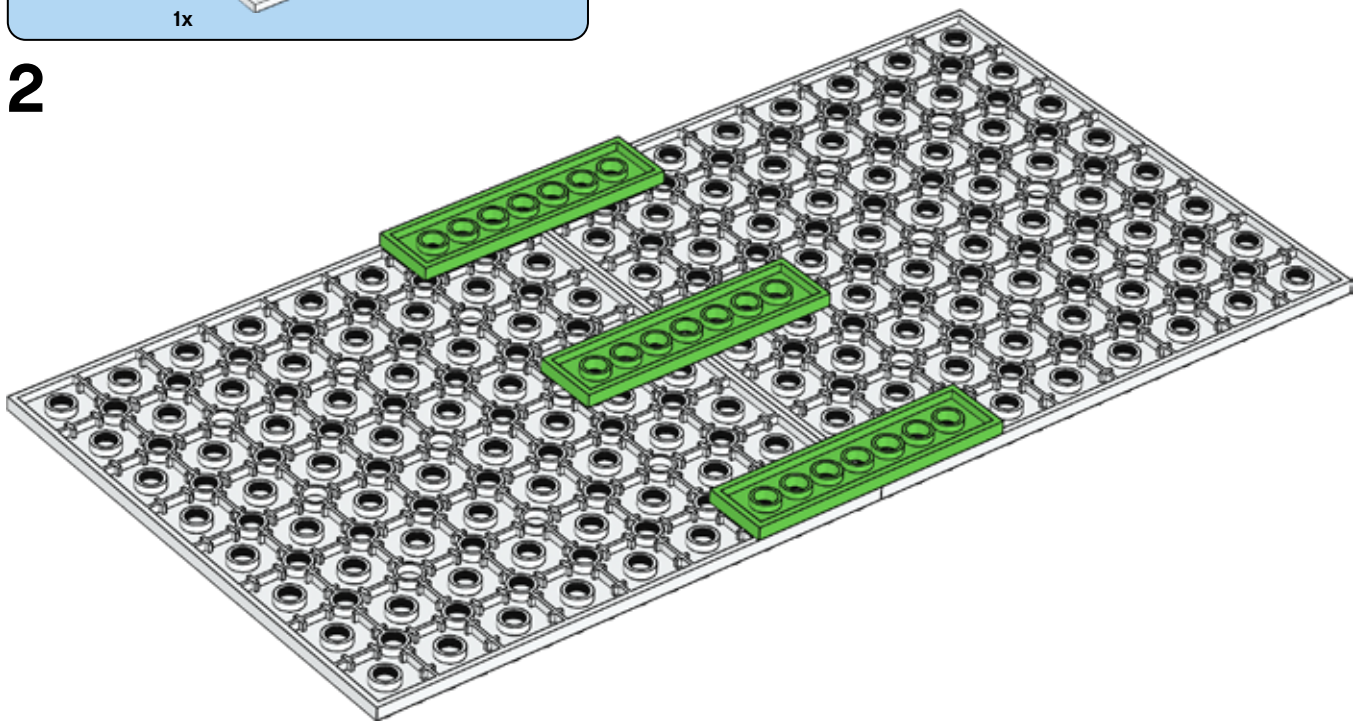

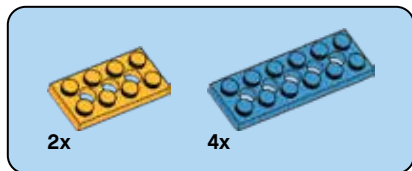

3

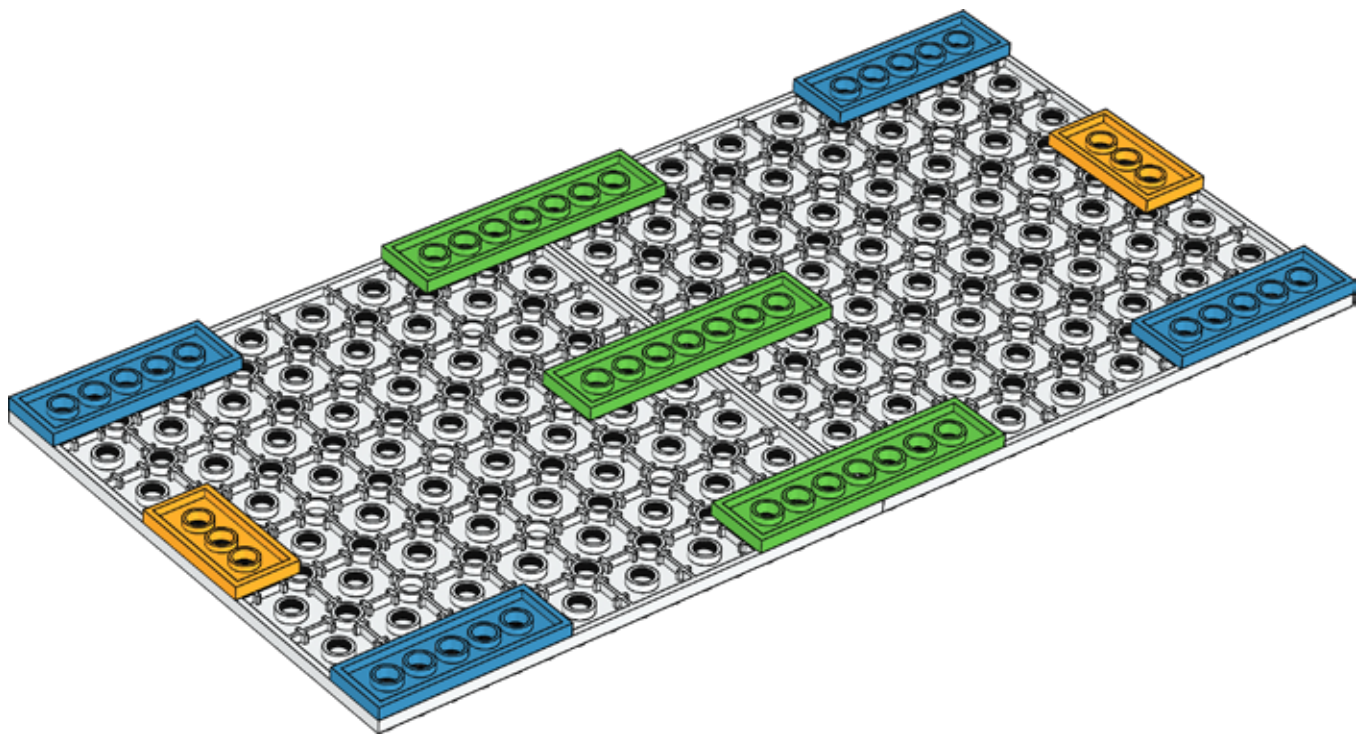

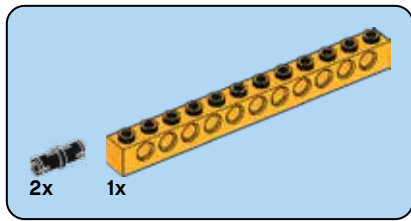

4

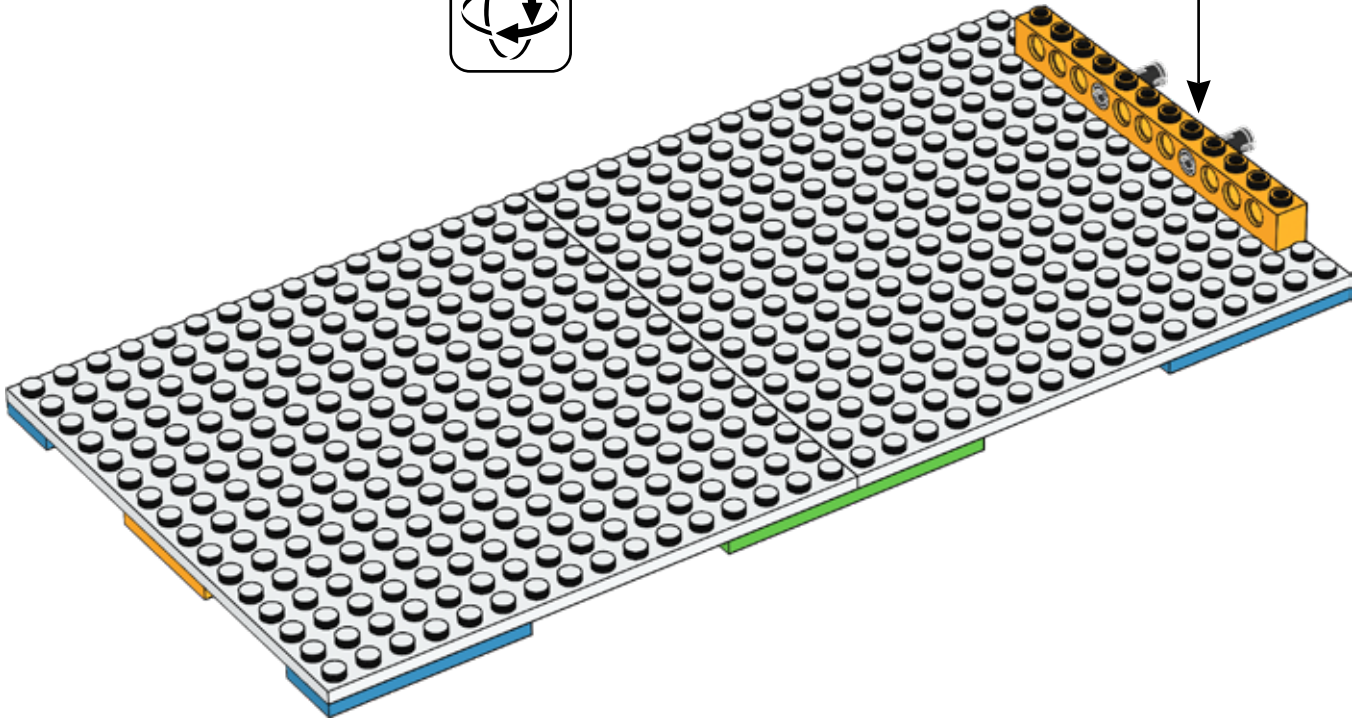
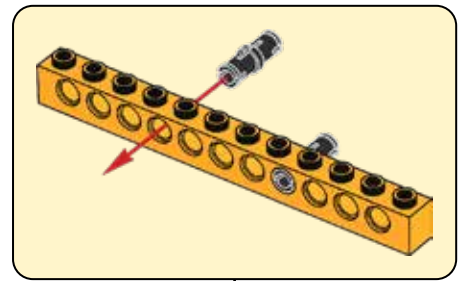
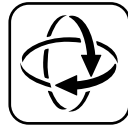



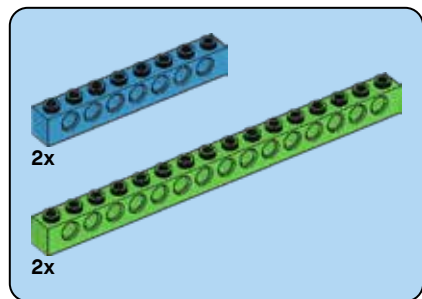

5

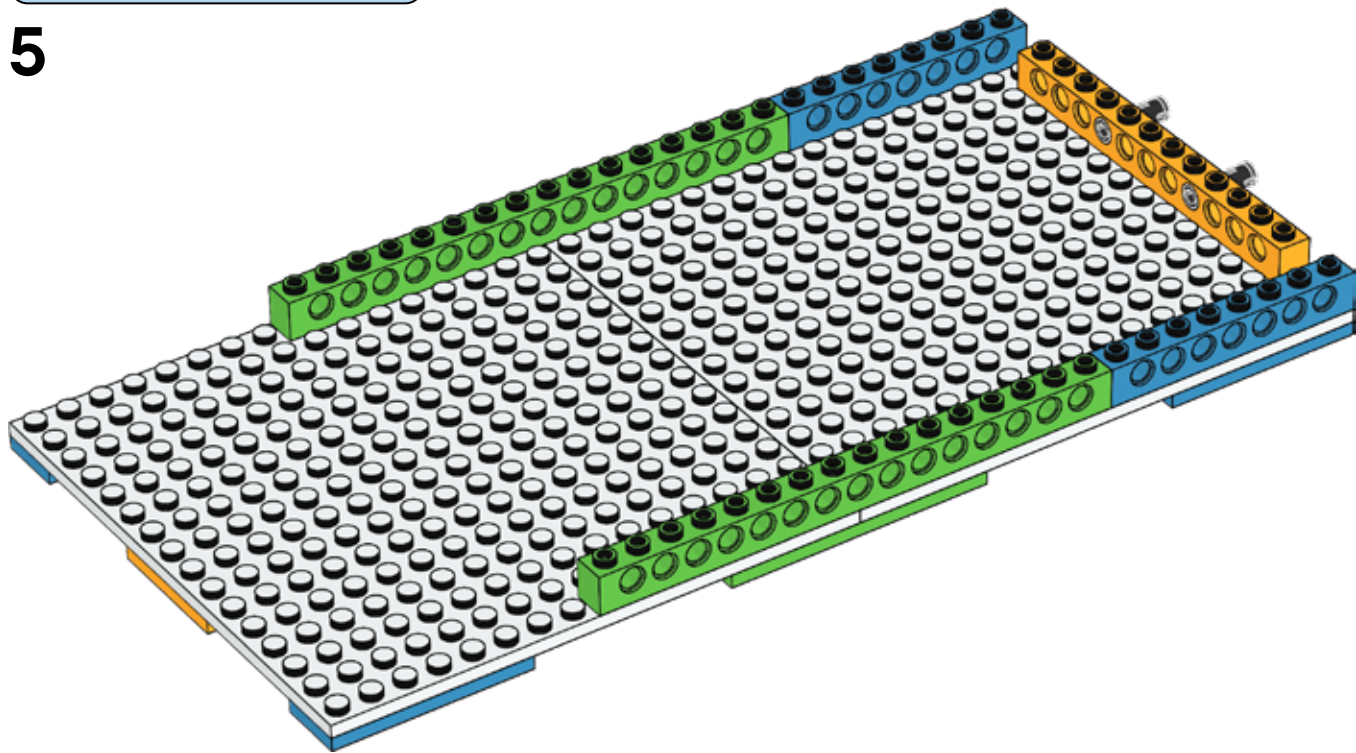



2x



2x

6

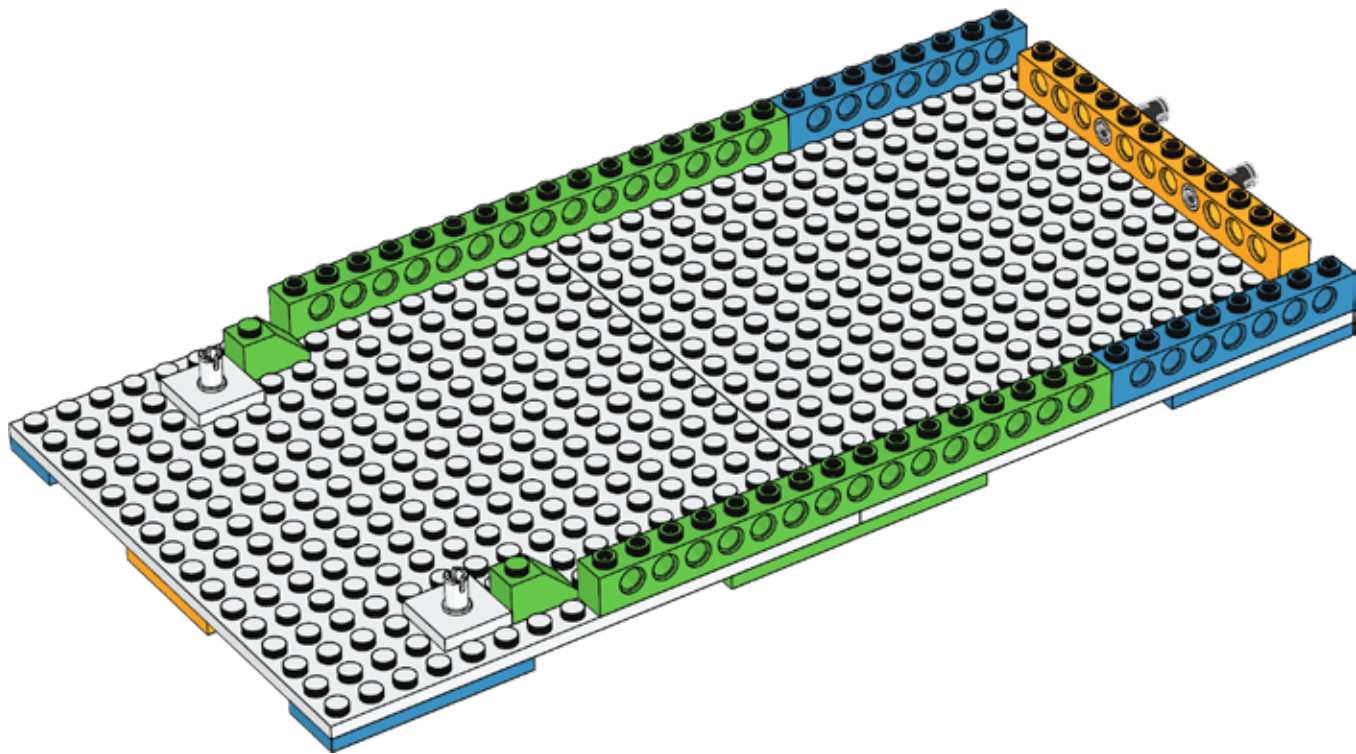





2x

8

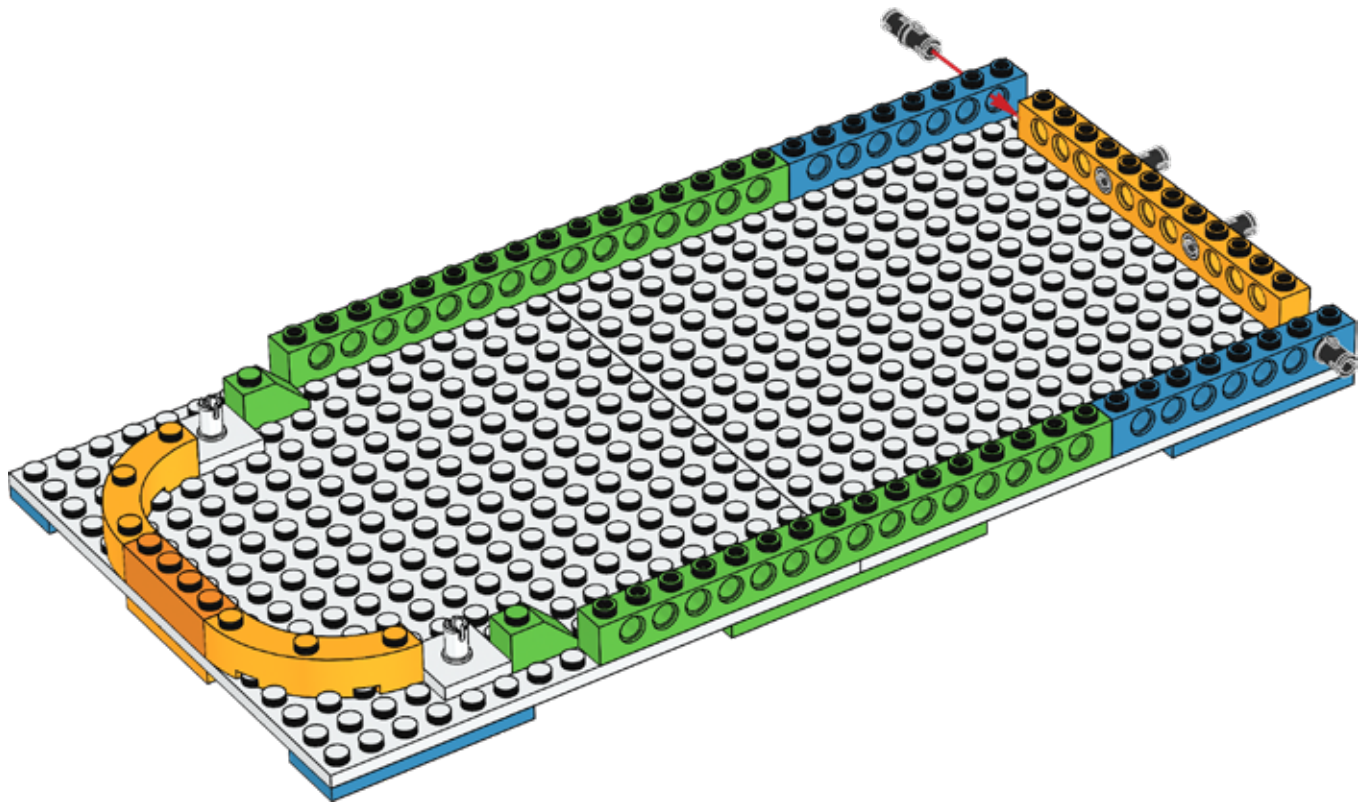



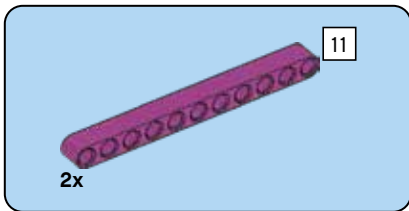

9

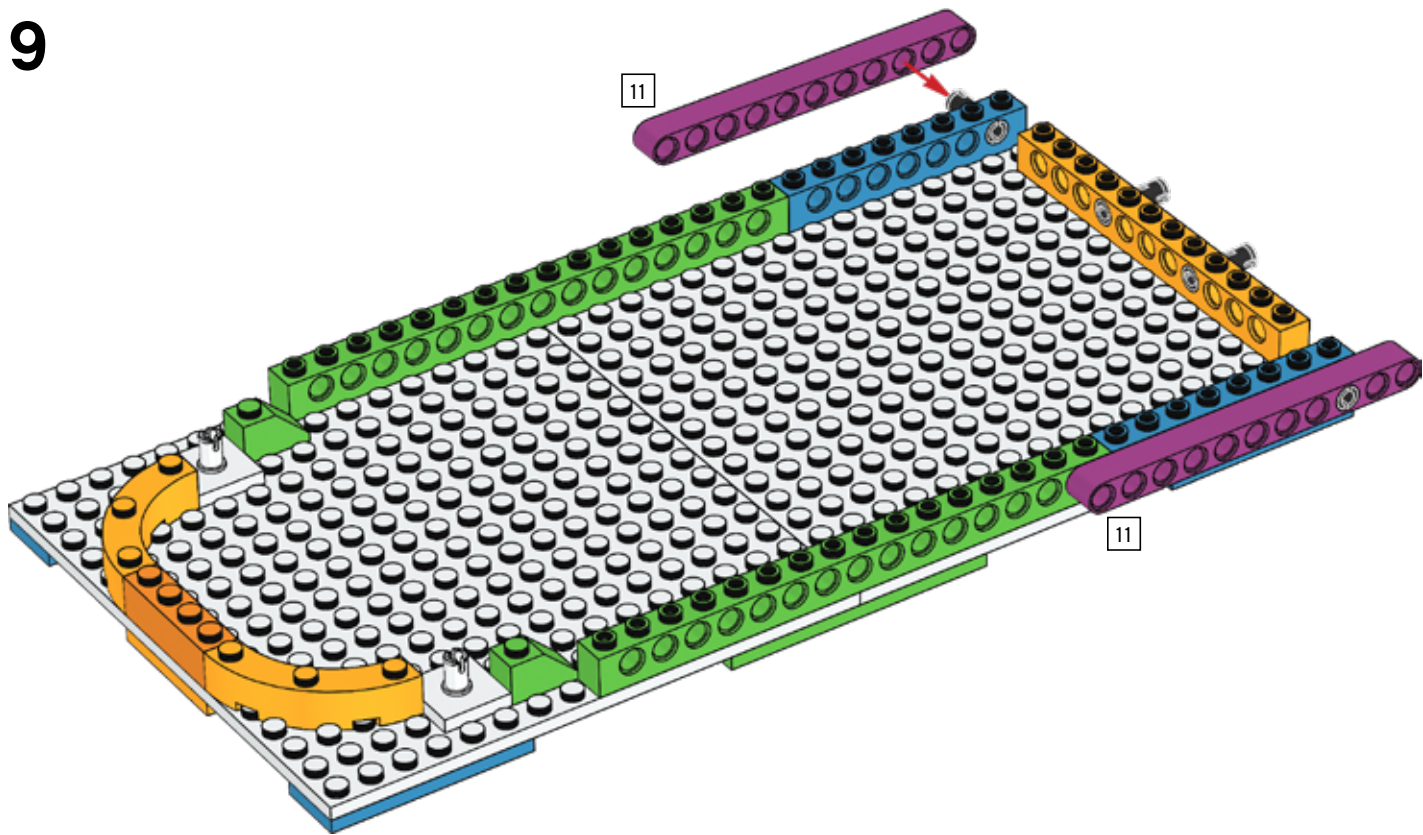



10

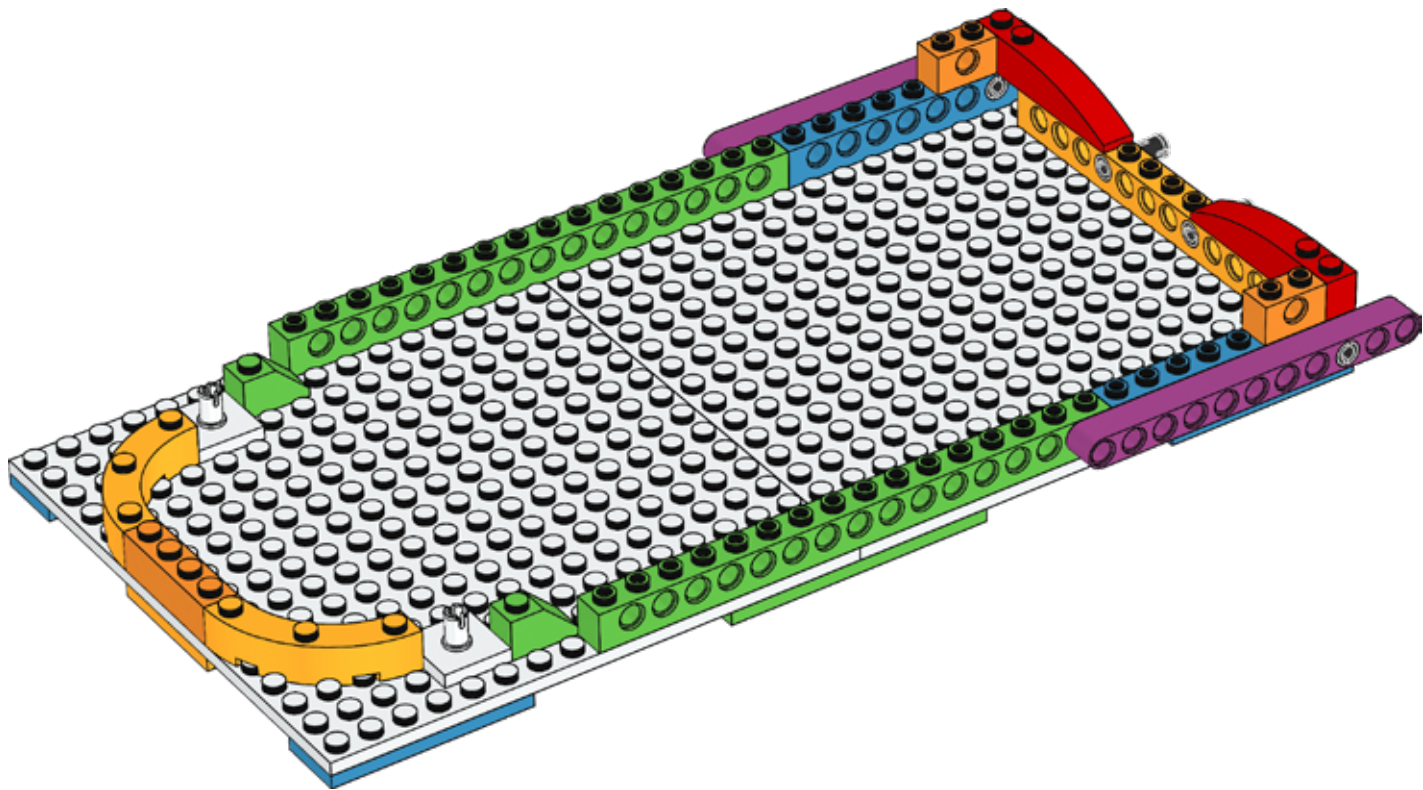



2x

11

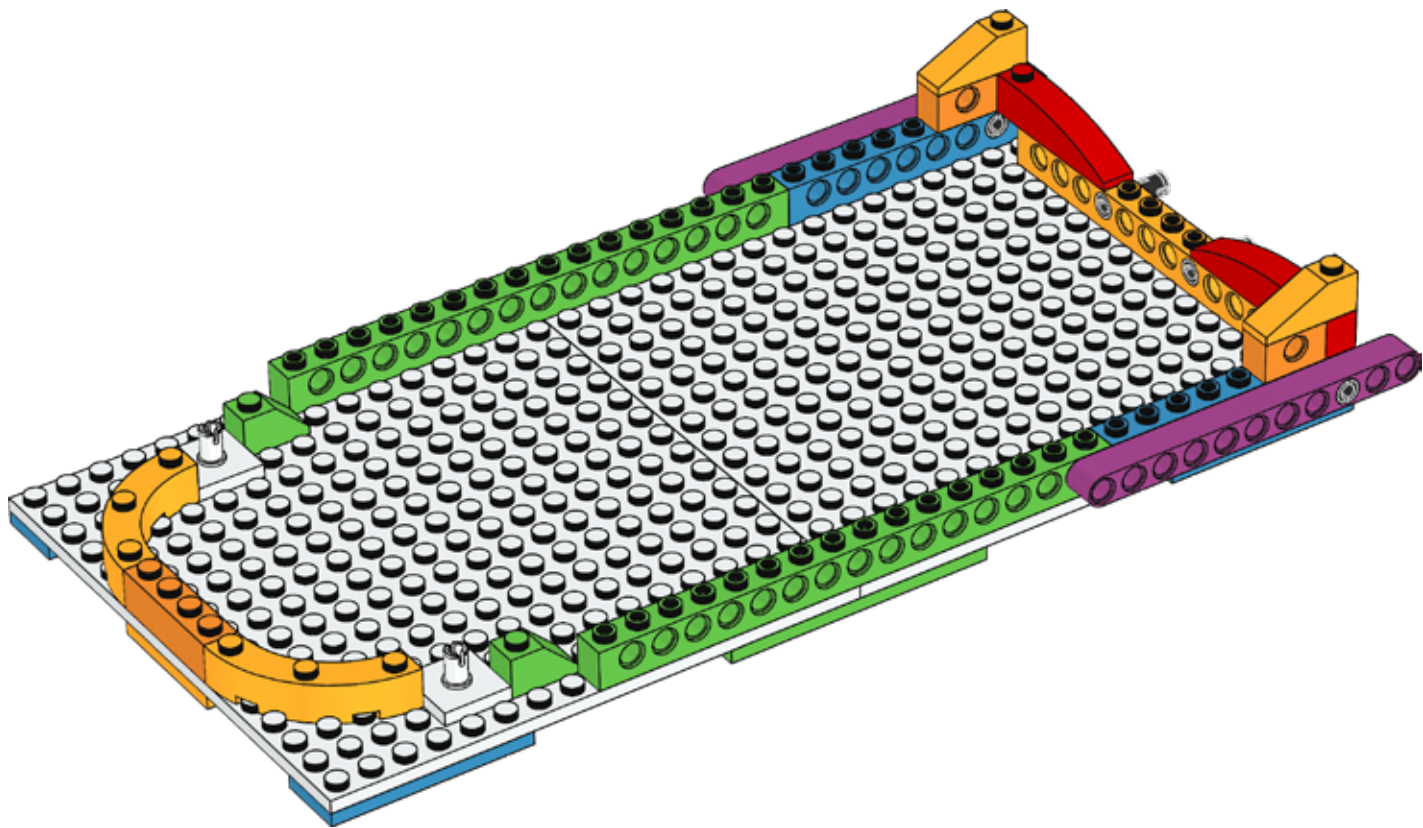



2x

12

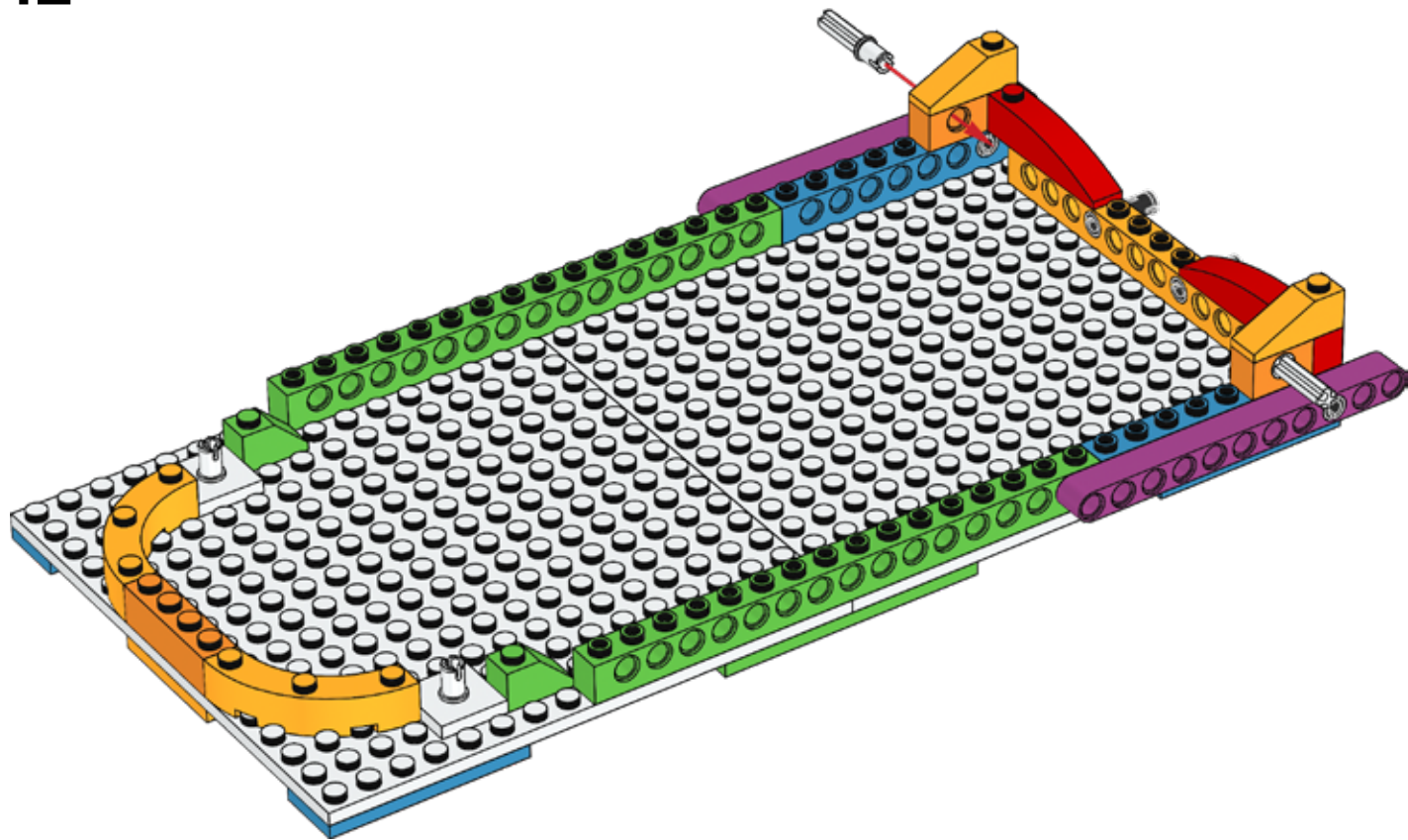





2x

13

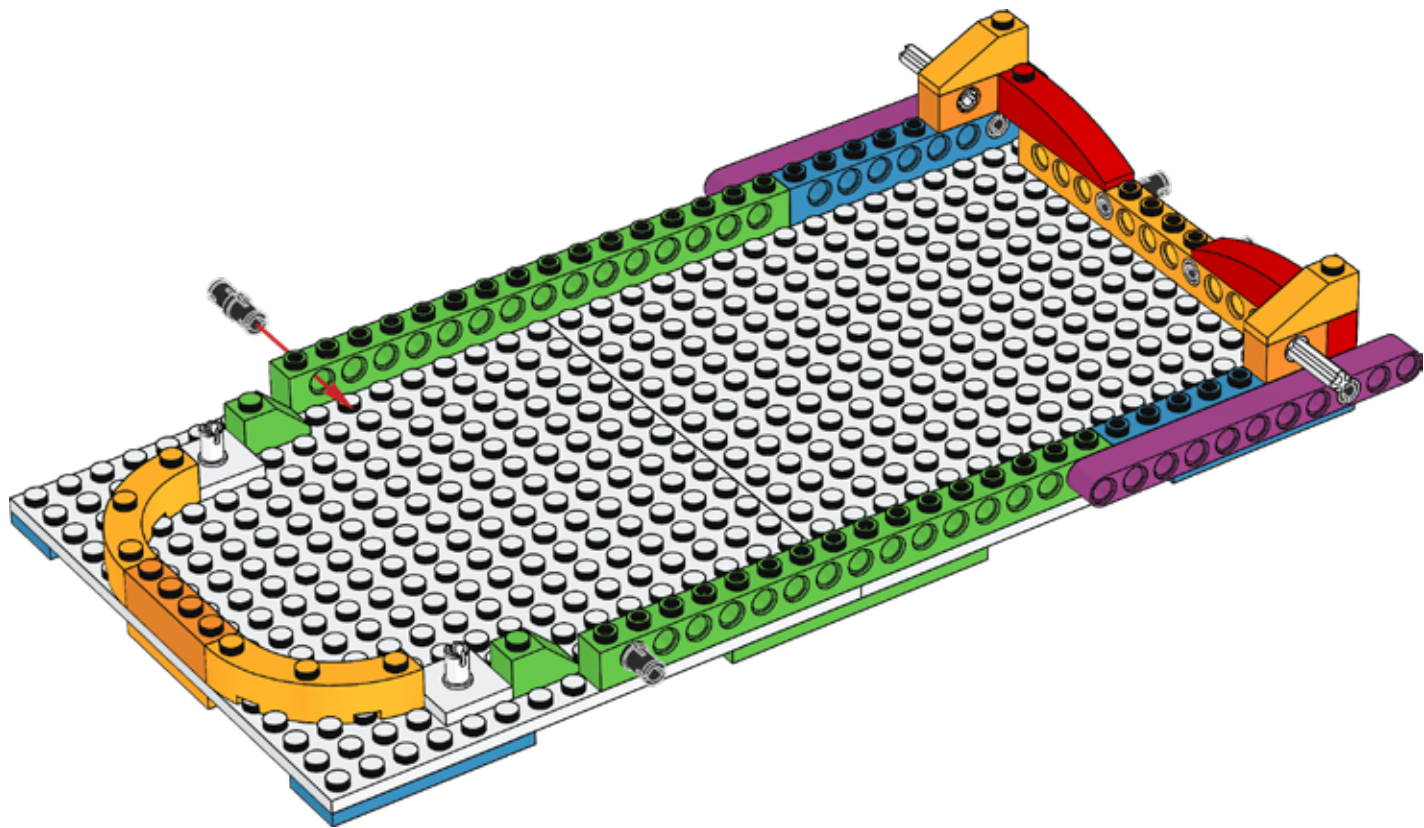





2x

15

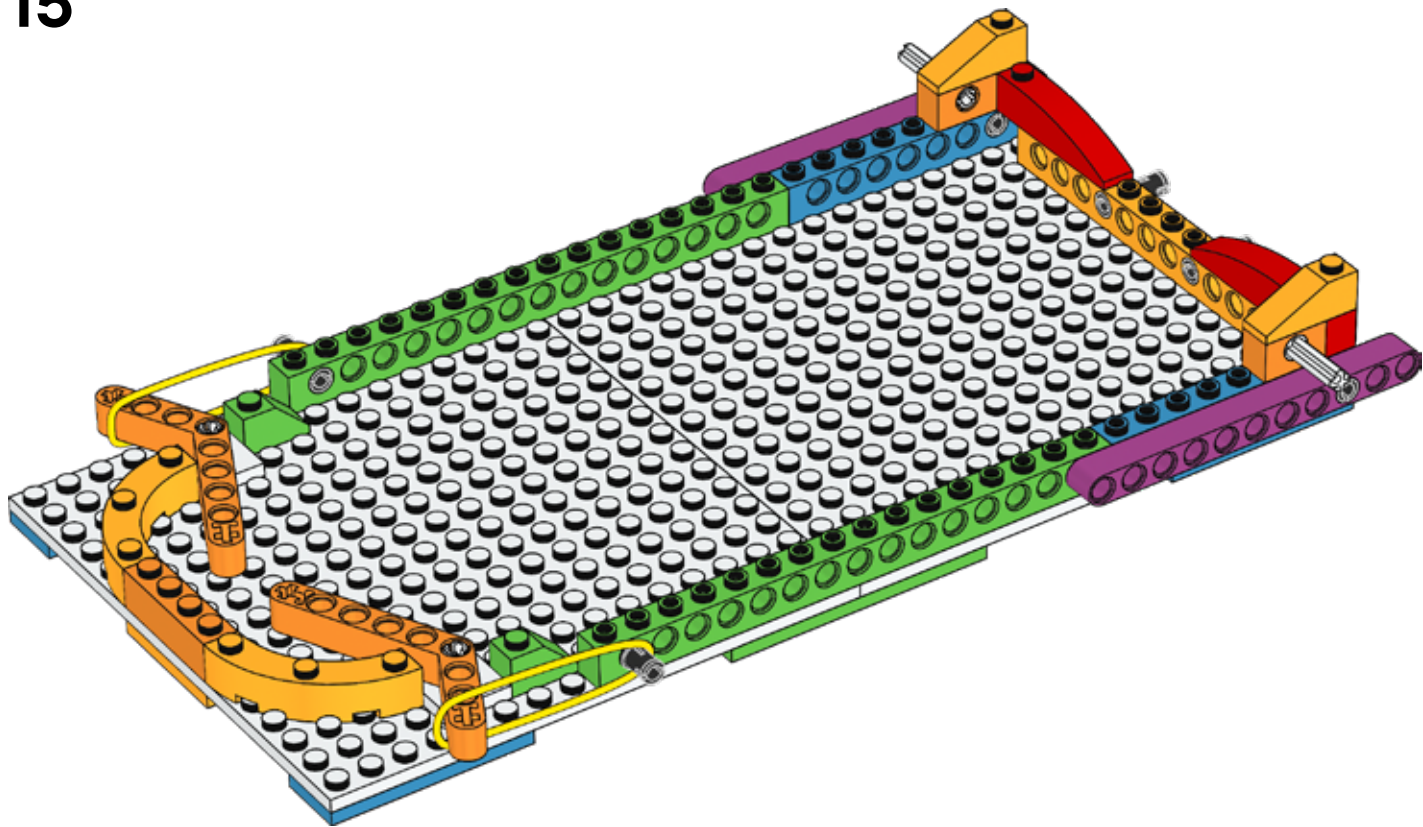

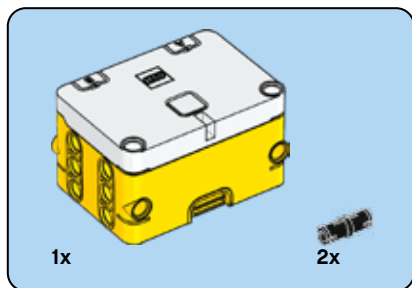

16

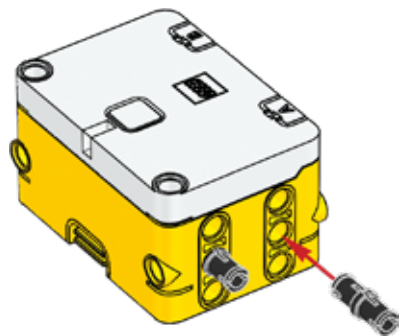



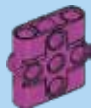

1x

17

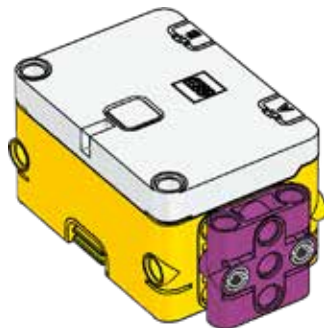



2x

18

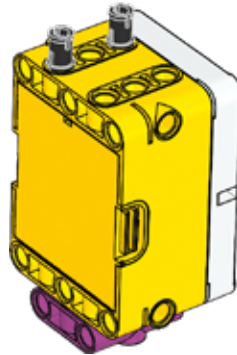
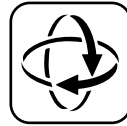

19

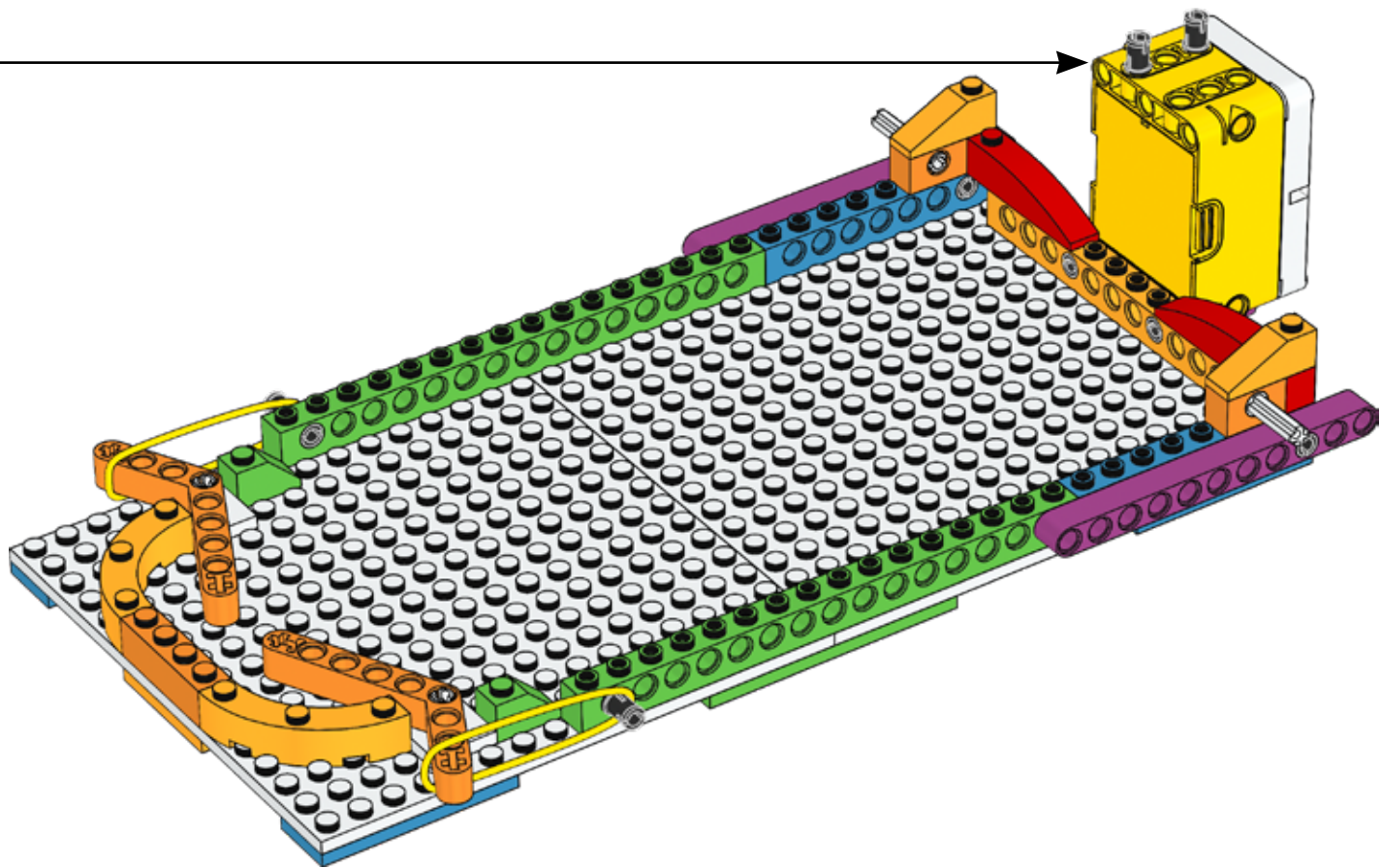

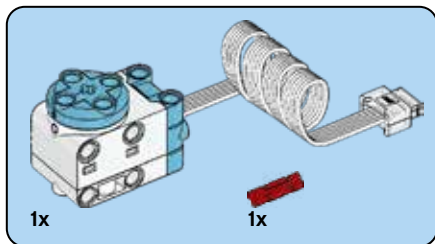

20

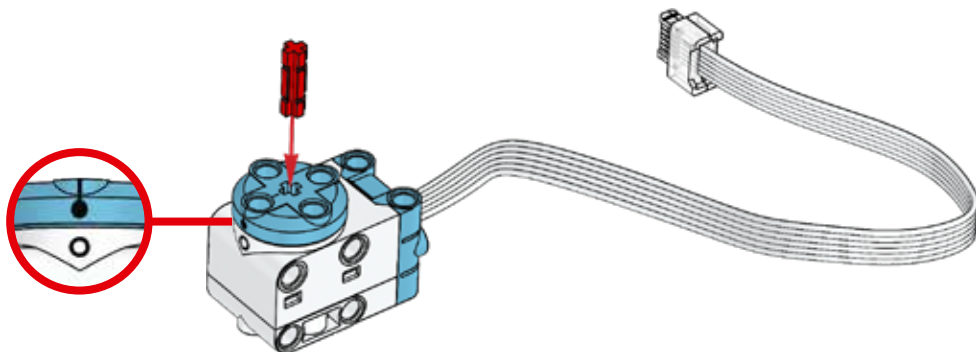





1x

21

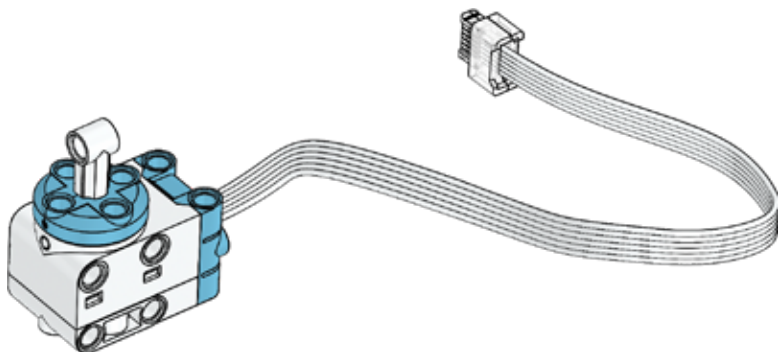

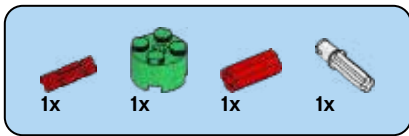

22

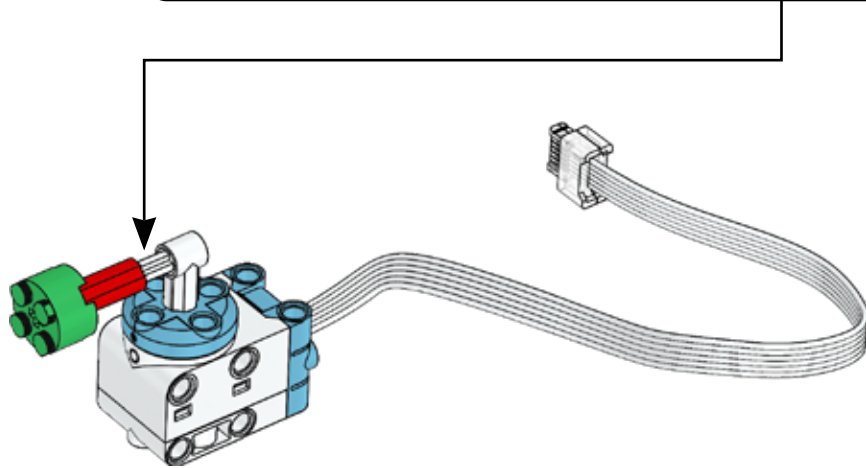
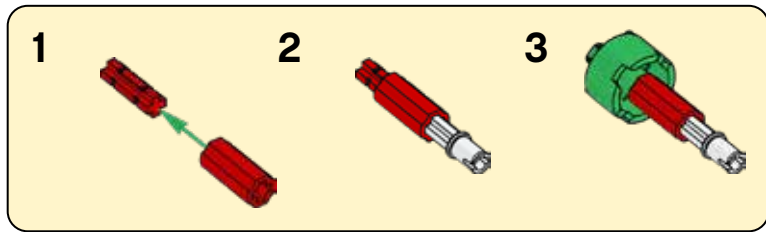



2x

23

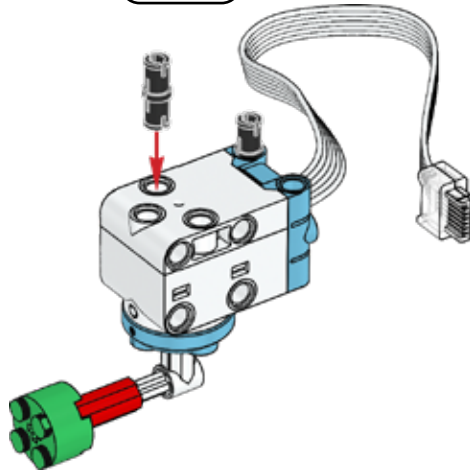
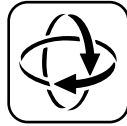

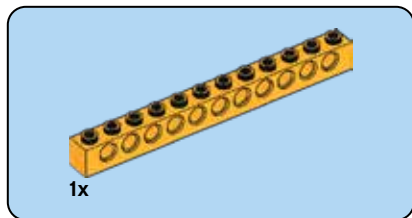

24

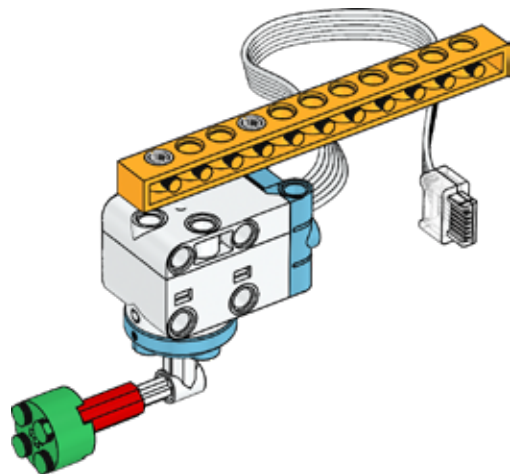





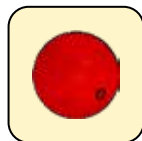
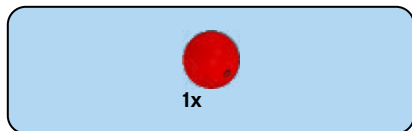

26

