

1

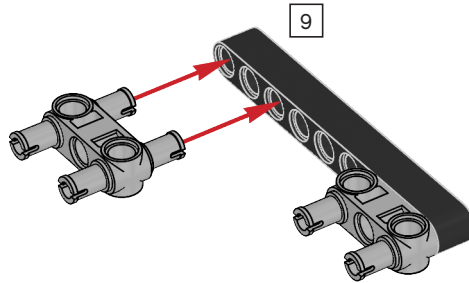

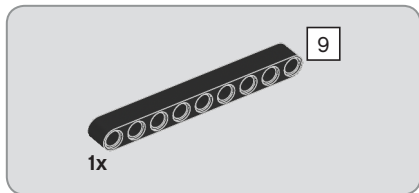

2





2x

3

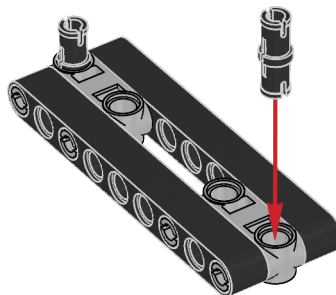



4x

4

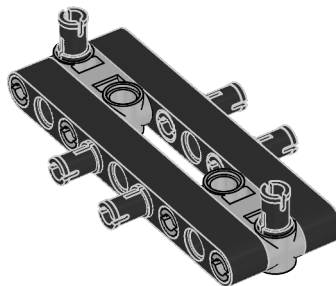

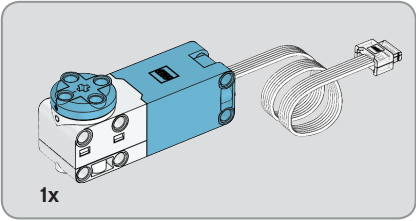

5

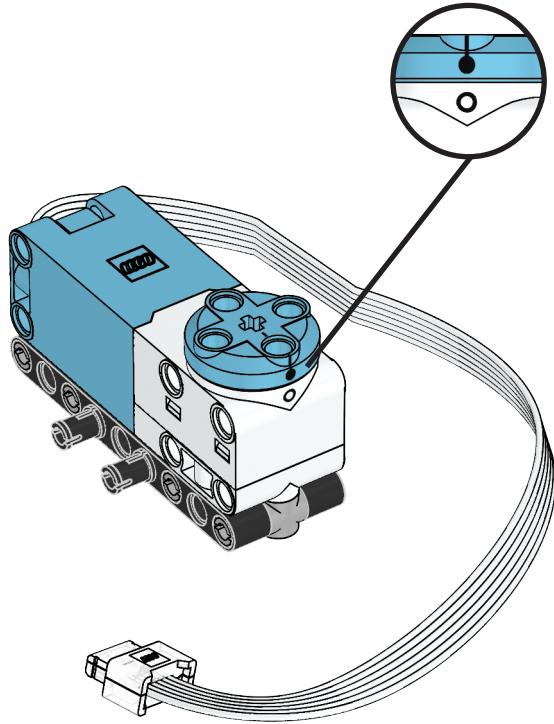



4x

6

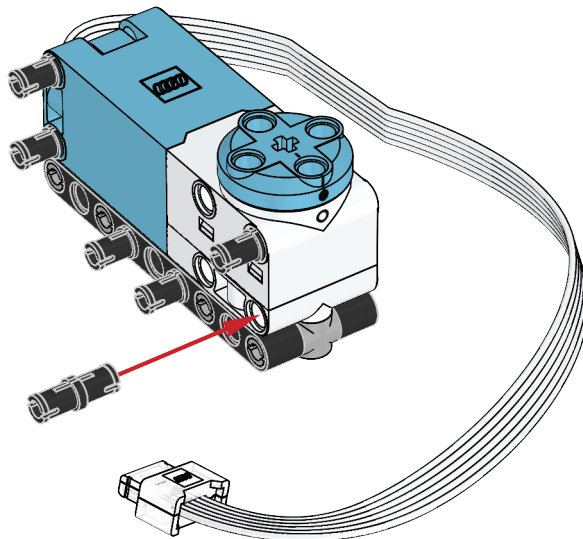

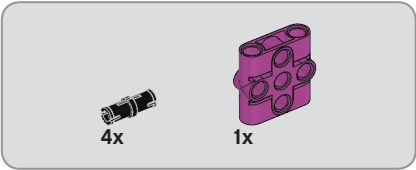
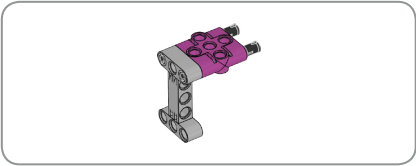

7

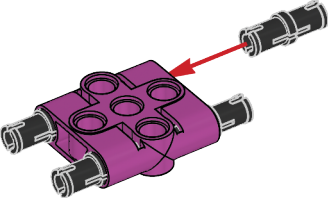

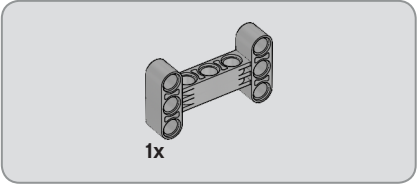

8

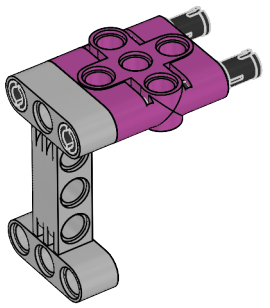



9

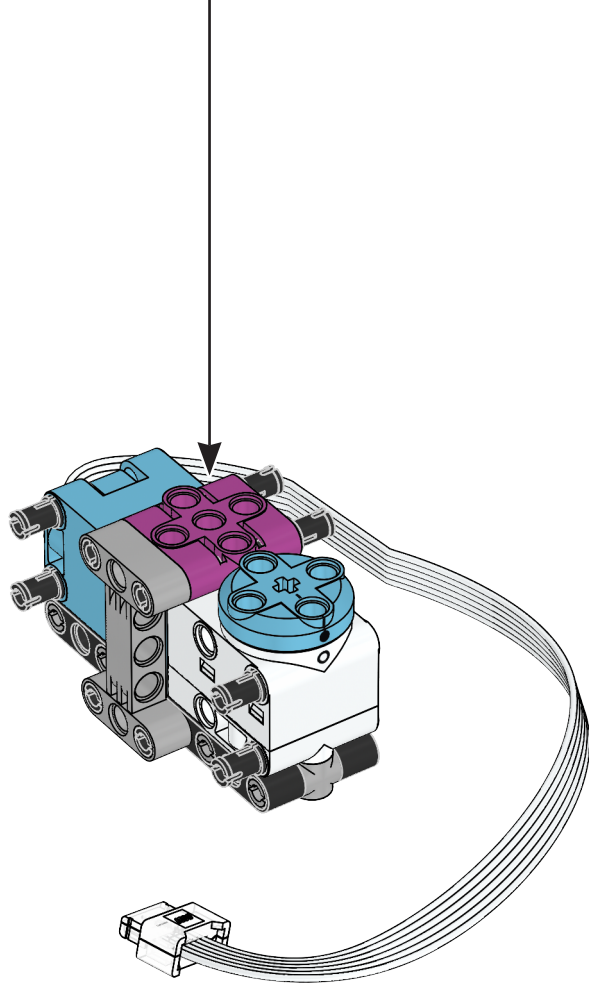

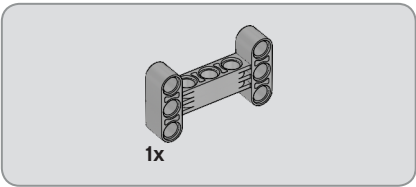

10

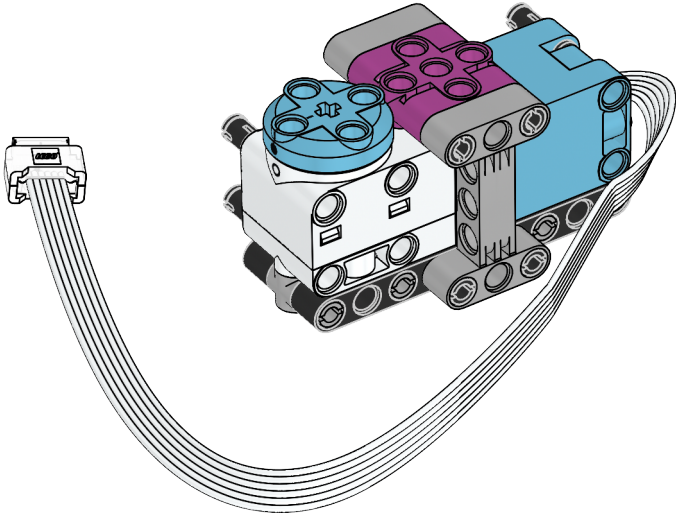

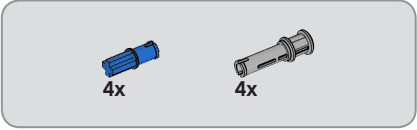

11

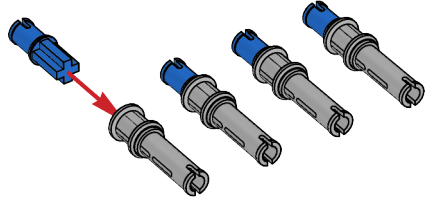

12

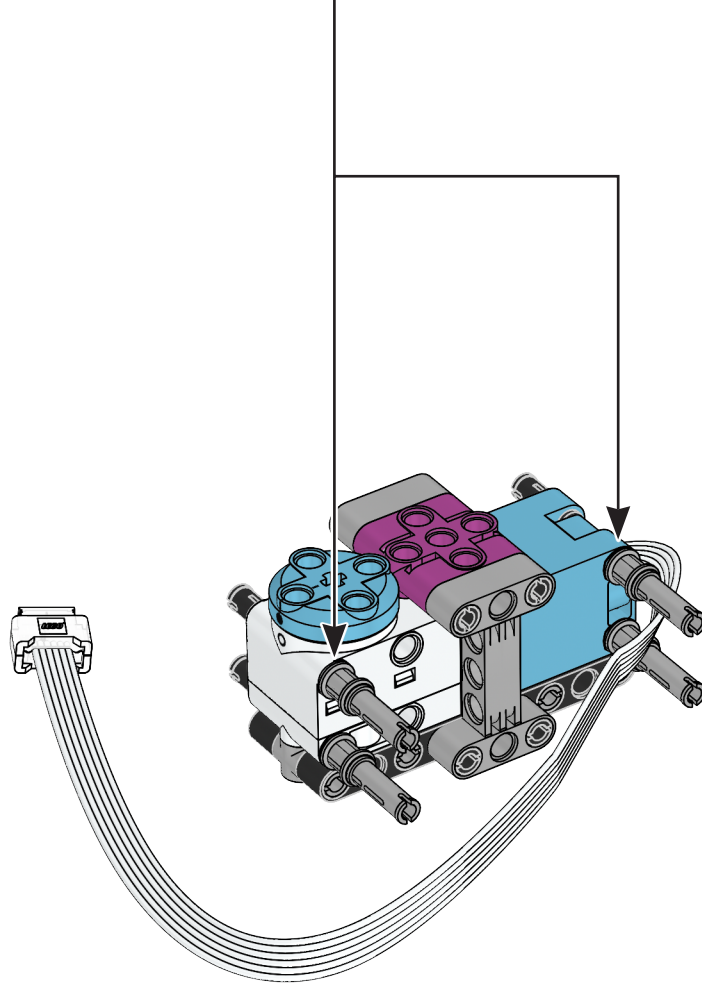

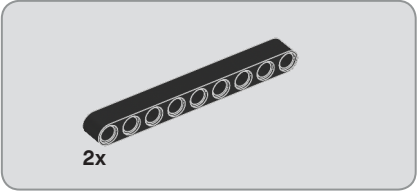

13

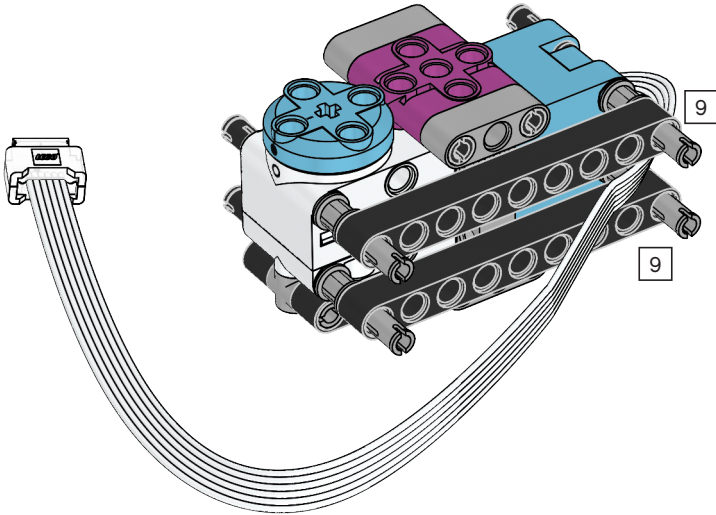



1x



1x

14

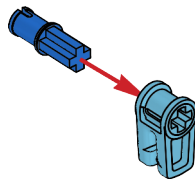

15

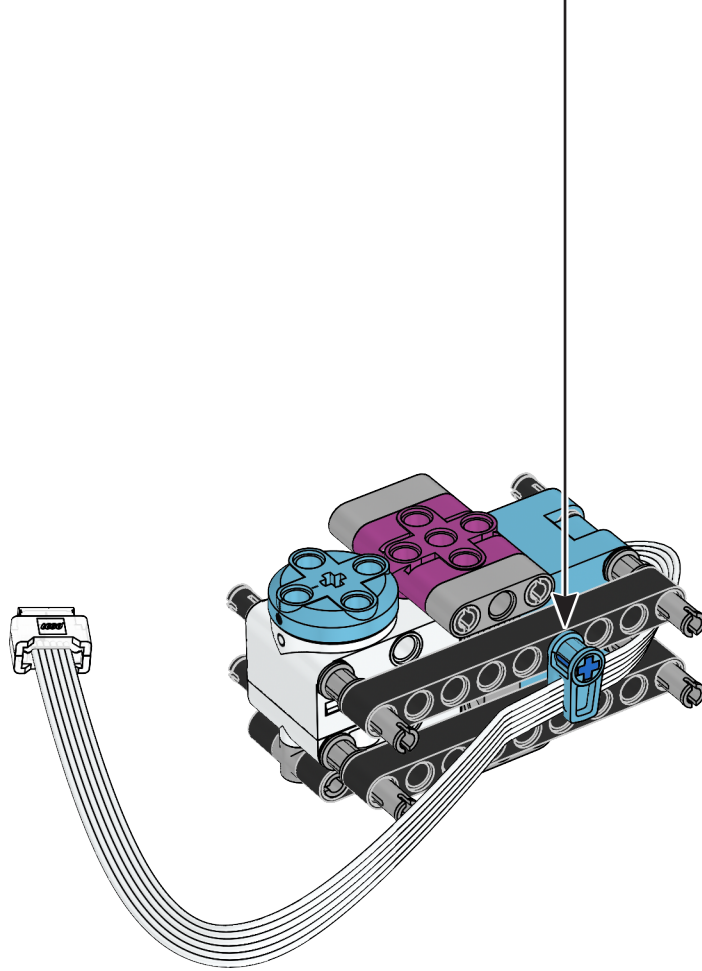

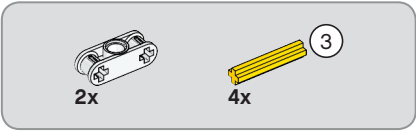
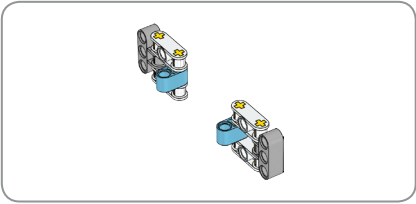

16

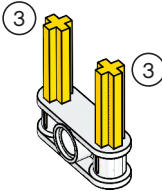
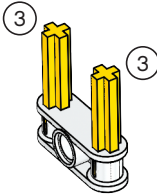





2x



2x

# 17

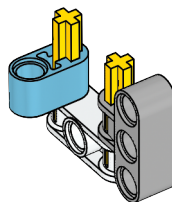
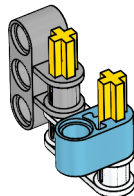



2x

18

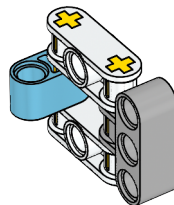
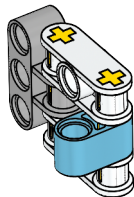

19

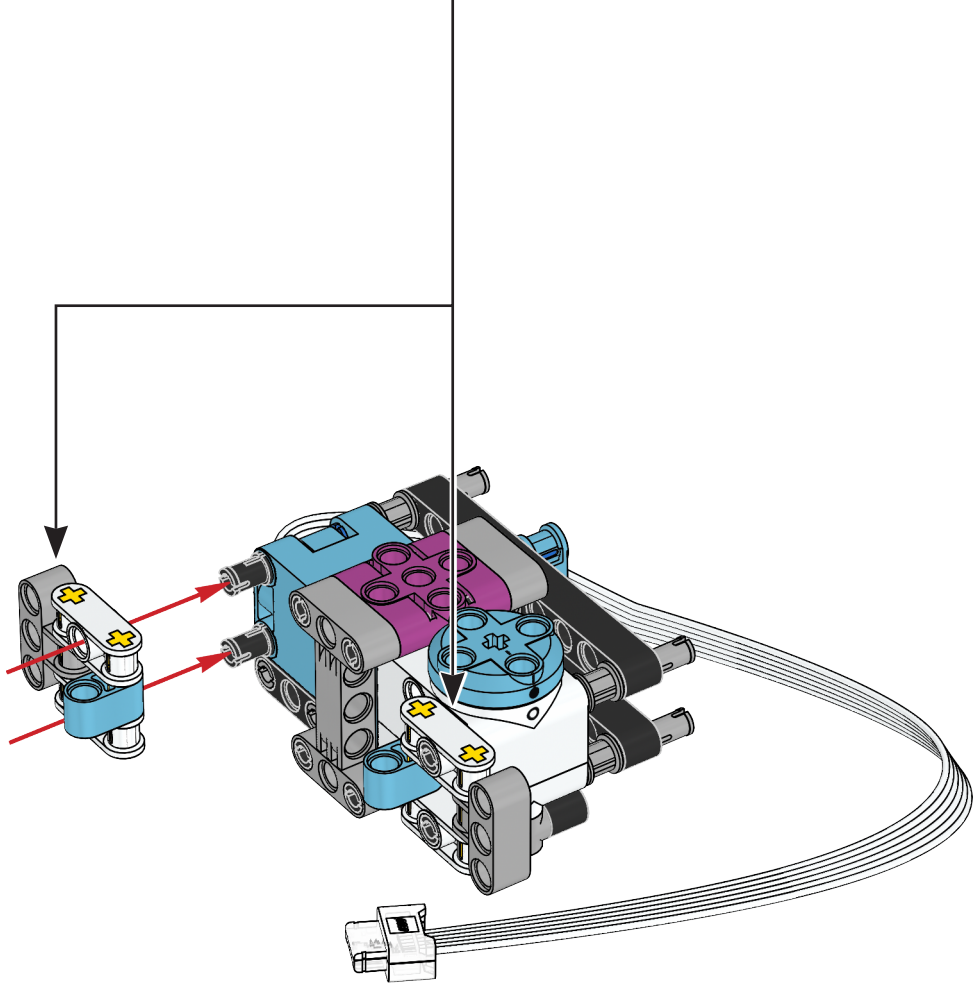

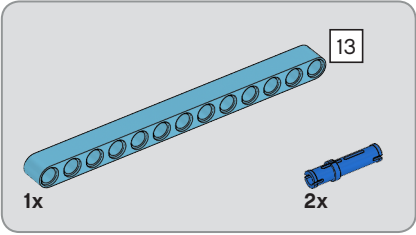
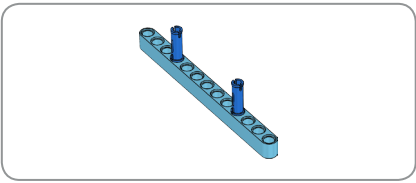

20

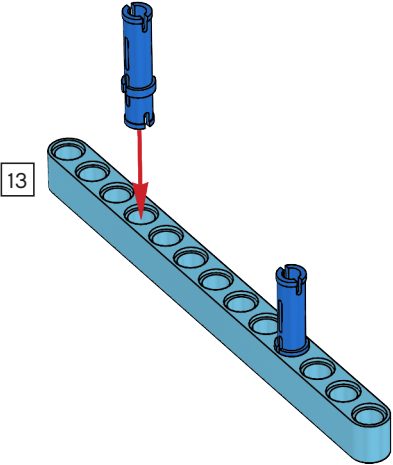

21

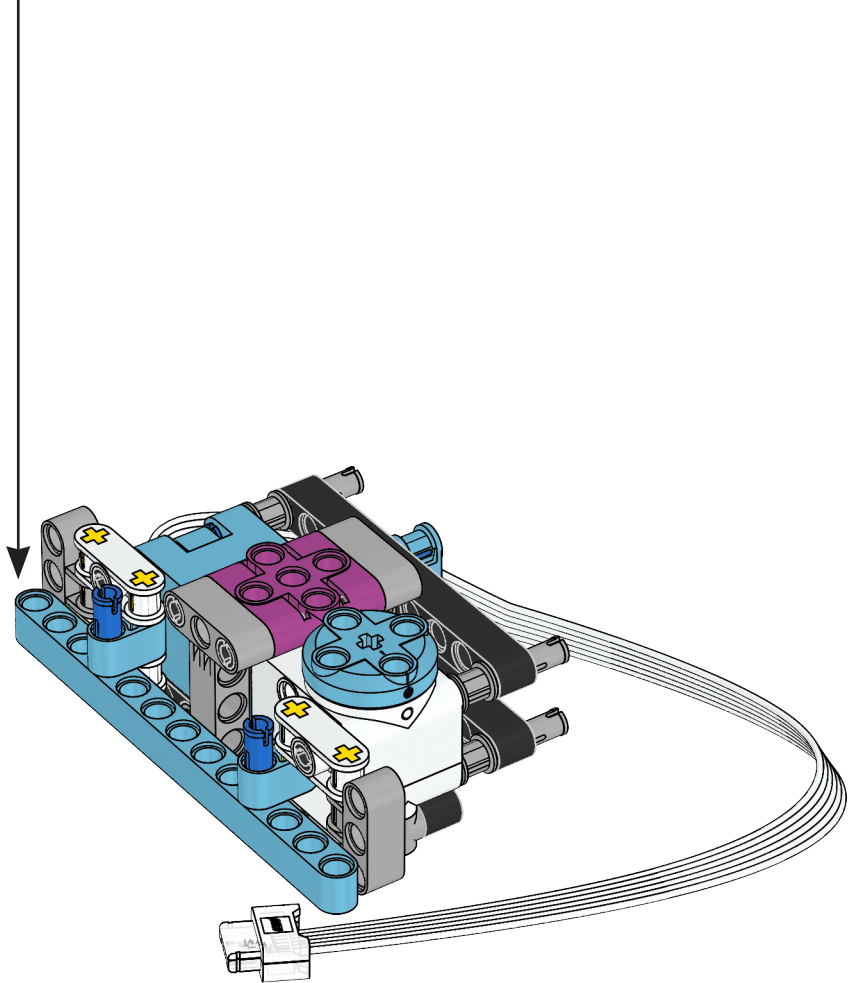

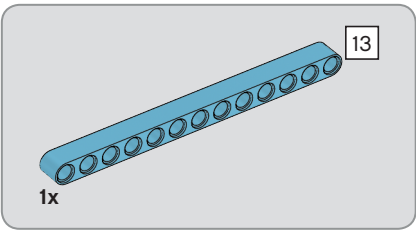

22

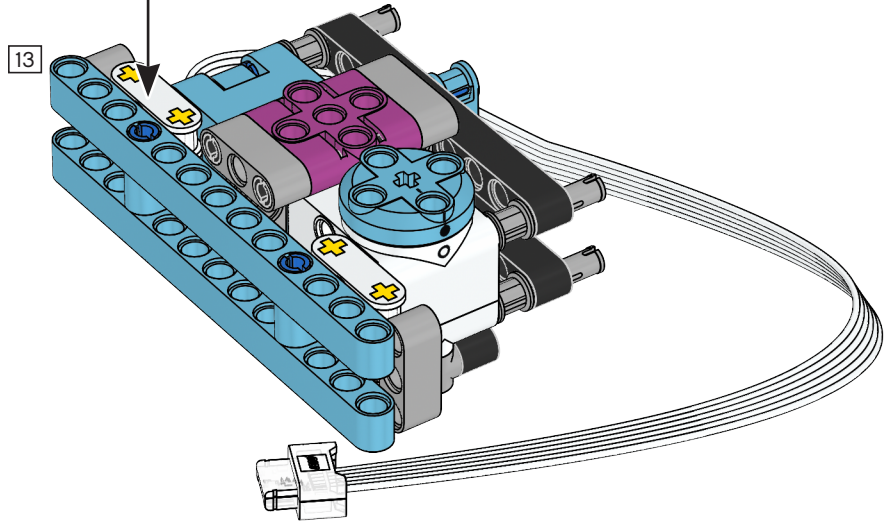

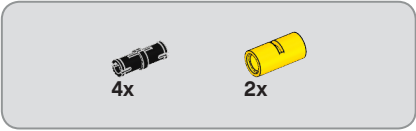
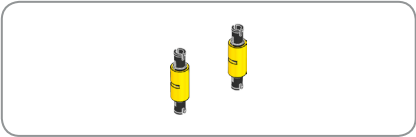

23

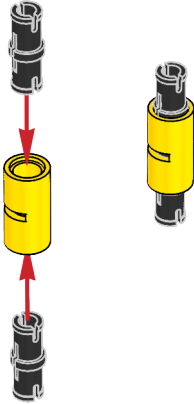

24

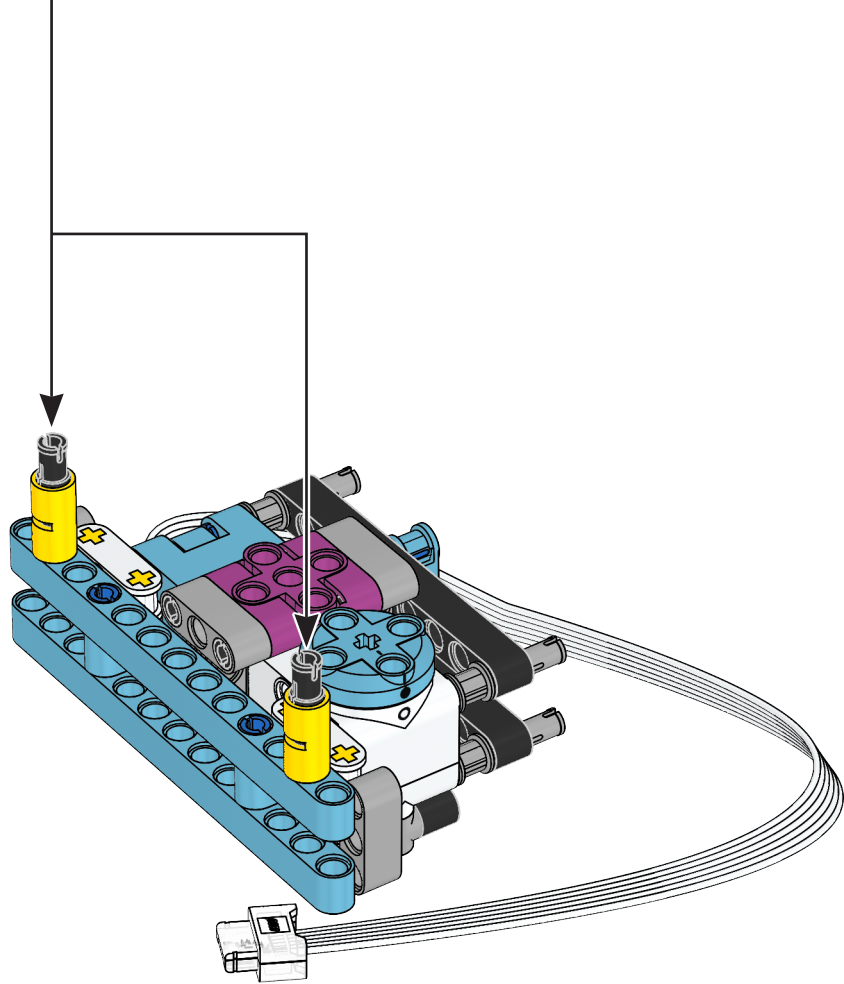





2x



1x

25

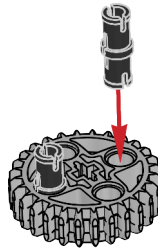

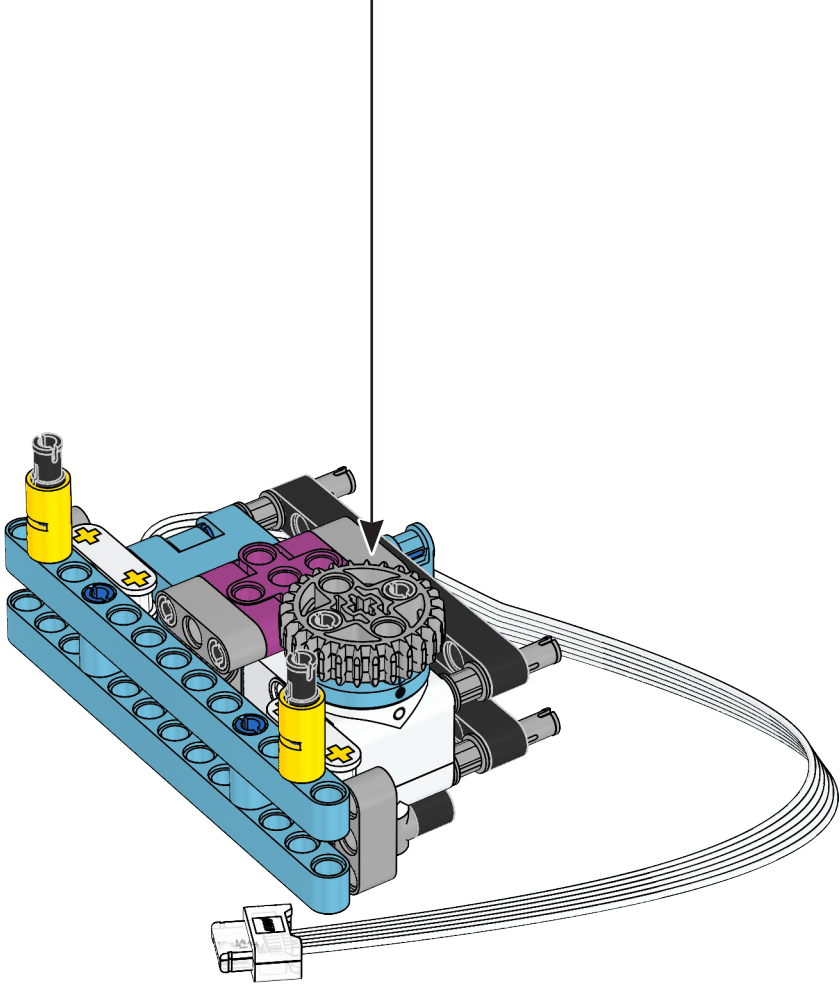

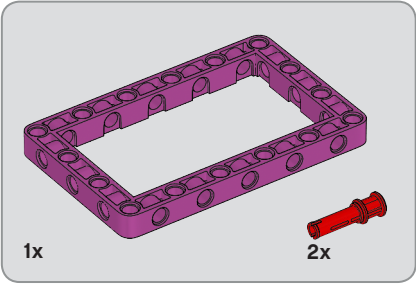
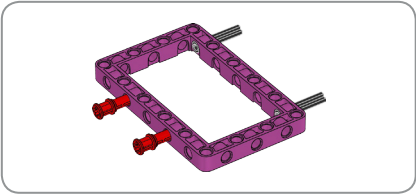

27

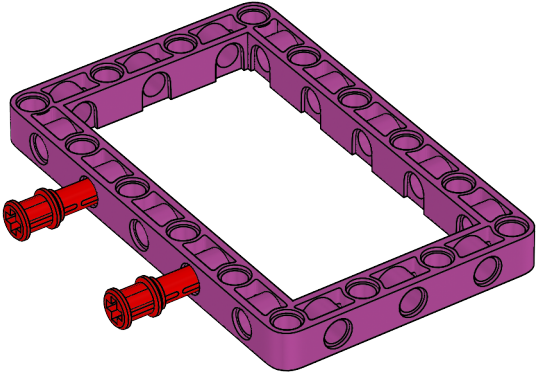



2x

28

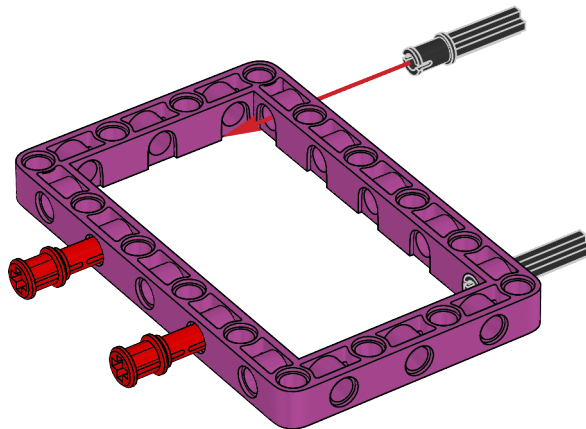

29

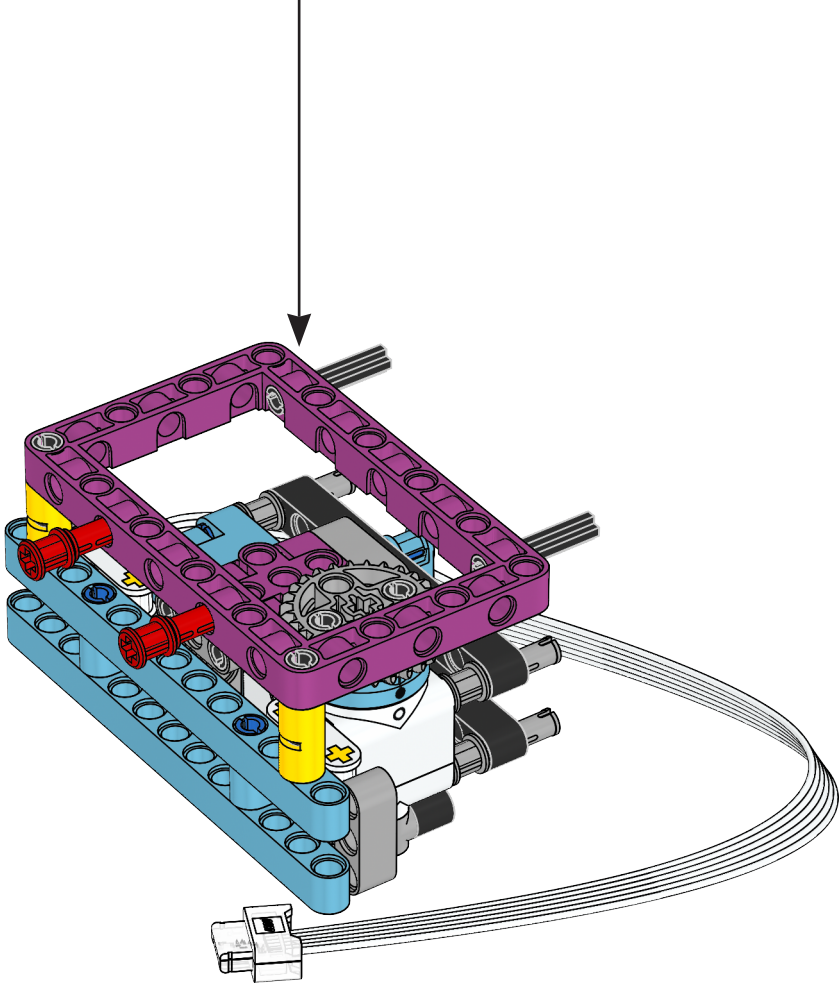

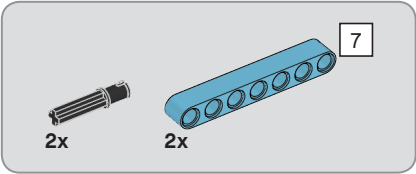
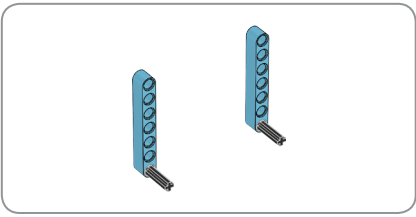

30

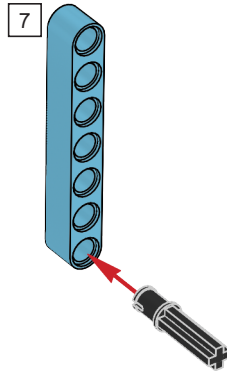
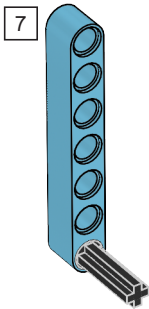

31

