

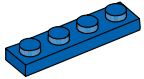

LEGO® Element Survey



8x
Plate, 1x2, blue
302323



4x
Plate, 1x4, blue
371023

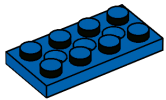

6x
Plate with holes, 2x4, blue
370923

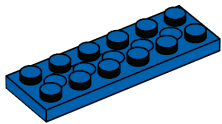

8x
Plate with holes, 2x6, blue
4114027

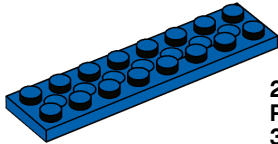

2x
Plate with holes, 2x8, blue
373823



4x
Studded beam, 1x2, blue
370023

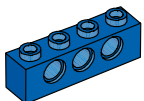

4x
Studded beam, 1x4, blue
370123

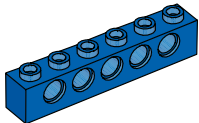

4x
Studded beam, 1x6, blue
389423

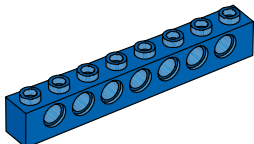

4x
Studded beam, 1x8, blue
370223



10x
Connector peg with friction,
3-module, blue
4514553

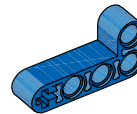

8x
Angular beam, 4x2-module, blue
4168114

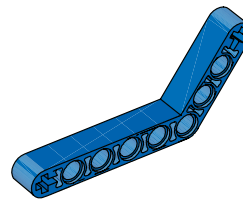

4x
Angular beam, 4x6-module, blue
4182884

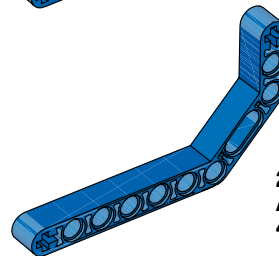



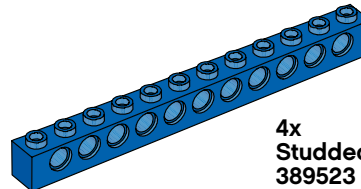



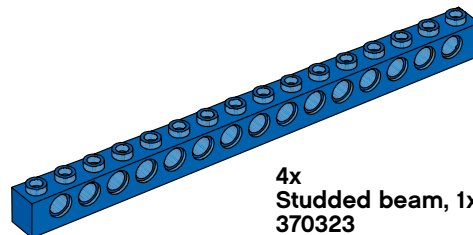



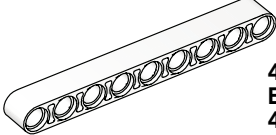

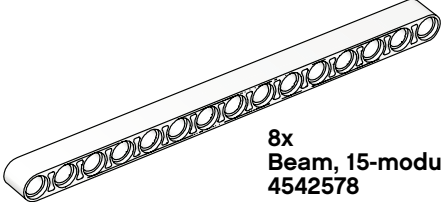
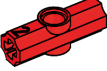
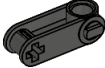





2x
Angular beam, 3x7-module, blue
4112000







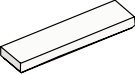

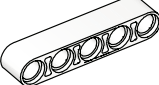
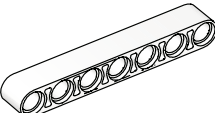

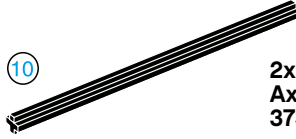

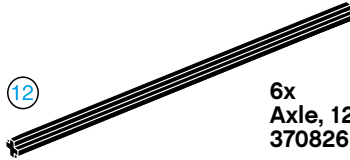











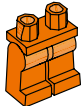
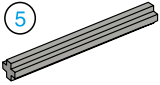
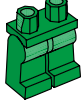





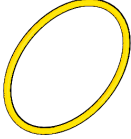

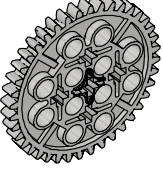

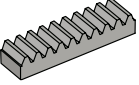
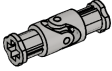



4x
Studded beam, 1x12, blue
389523

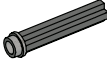
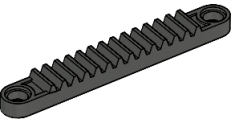

4x
Studded beam, 1x16, blue
370323

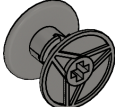
| | | | |
|---|--|--|---|
|  | 14x Axle, 2-module, red 4142865 |  | 4x Beam, 9-module, white 4156341 |
|  | 14x Connector peg with bushing, red 4140806 |  | 8x Beam, 15-module, white 4542578 |
|  | 4x Angular block, 2 (180°), red 4234429 |  | 2x Steering arm, black 4114670 |
|  | 10x Angular block with crosshole, red 4118897 |  | 2x Bearing for steering arm, black 4114671 |
|  | 4x Cross block, 3-module, red 4175442 |  | 4x Angular block, 1 (0°), dark grey 4210658 |
|  | 2x Tube, 2-module, red 4526984 |  | 4x Angular block, 3 (157,5°), black 4107082 |
|  | 4x Studded beam, 1x2 with crosshole, white 4233486 |  | 28x Connector peg with friction, black 4121715 |
|  | 2x Brick, 2x4, white 300101 |  | 4x Tyre, 30,4x4, black 281526 |
|  | 2x Brick, 2x2 round, white 614301 |  | 4x Tyre, 30,4x14, black 4140670 |
|  | 4x Roof brick, 1x2/45°, white 4121932 |  | 4x Tyre, 43,2x22, black 4184286 |
|  | 2x Tile, 1x4, white 243101 | | |
|  | 2x Beam, 3-module, white 4208160 | | |
|  | 2x Beam, 5-module, white 4249021 | | |
|  | 2x Beam, 7-module, white 4495927 | | |

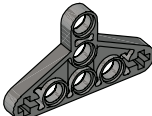
| | | | |
|---|--|---|---|
|  | 12x Connector peg with axle, beige 4186017 |  | 2x Axle, 10-module, black 373726 |
|  | 4x Connector peg, 3-module, beige 4514554 |  | 6x Axle, 12-module, black 370826 |
|  | 16x Bushing, 1/2-module, yellow 4239601 |  | 1x Minifigure, ponytail wig, black 609326 |
|  | 4x Connector peg, handle, grey 4211688 |  | 1x Minifigure, cap, red 448521 |
|  | 8x Connector peg, grey 4211807 |  | 2x Minifigure, head, yellow 9336 |
|  | 16x Bushing, grey 4211622 |  | 1x Minifigure, body, white with surfer 4275606 |
|  | 8x Axle extender, 2-module, grey 4512360 |  | 1x Minifigure, body, white with flowers 4275536 |
|  | 8x Axle, 3-module, grey 4211815 |  | 1x Minifigure, legs, orange 4120158 |
|  | 4x Axle, 5-module, grey 4211639 |  | 1x Minifigure, legs, green 74040 |
|  | 8x Axle, 4-module, black 370526 | | |
|  | 2x Axle, 6-module, black 370626 | | |
|  | 2x Axle, 8-module, black 370726 | | |

| | | | |
|---|--|--|---|
|  | 2x Gear, 16-tooth, grey 4211563 |  | 2x Belt, 33 mm, yellow 4544151 |
|  | 4x Gear, 24-tooth crown, grey 4211434 |  | 2x Belt, 24 mm, red 4544143 |
|  | 2x Gear, 40-tooth, grey 4285634 |  | 2x Belt, 15 mm, white 4544140 |
|  | 2x Gear, 10-tooth rack, grey 4211450 |  | 1x Universal joint, 3-module, grey 4525904 |
|  | 2x Worm gear, grey 4211510 |  | 4x Hub, 18x14, grey 4490127 |
|  | 1x Differential, 28-tooth, dark grey 4525184 |  | 4x Hub, 24x4, grey 4494222 |
|  | 4x Gear, 24-tooth, dark grey 4514558 |  | 4x Hub, 30x20, grey 4297210 |
|  | 6x Gear, 8-tooth, dark grey 4514559 |  | 6x Connector peg, 1½-module, dark grey 4211050 |
|  | 2x Gear, 12-tooth double bevel, black 4177431 |  | 4x Axle with knob, 3-module, dark grey 4211086 |
|  | 1x Gear, 14-tooth rack, black 4275503 |  | 4x Cam wheel, dark grey 4210759 |
|  | 6x Gear, 12-tooth bevel, beige 4514556 |  | 1x Bobbin, dark grey 4239891 |
|  | 2x Gear, 20-tooth bevel, beige 4514557 |  | 2x ½ beam, triangle, dark grey 4210689 |
|  | 2x Gear, 20-tooth double bevel, beige 4514555 | | |

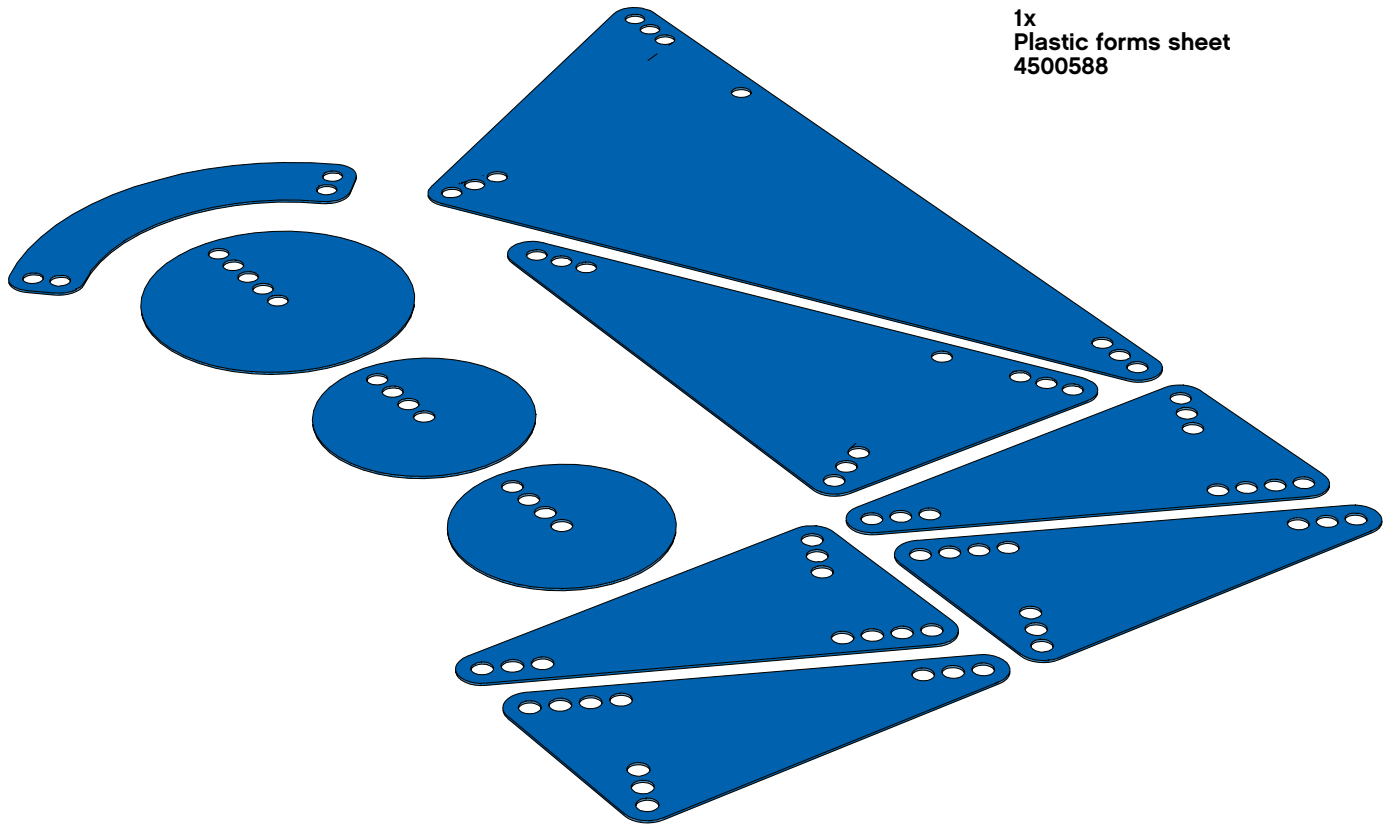

1x
Plastic forms sheet
4500588

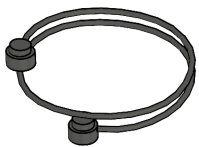

2x
String, 40-module with knobs,
black
4528334

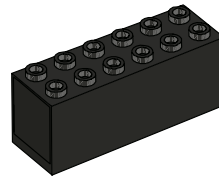

1x
Weight element, black
73843



1x
String, 2 m, black
4276325

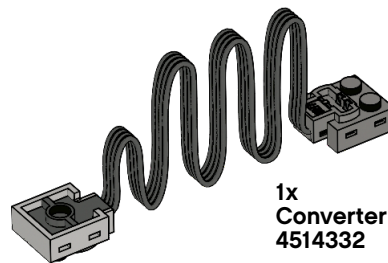

1x
Converter cable, black
4514332

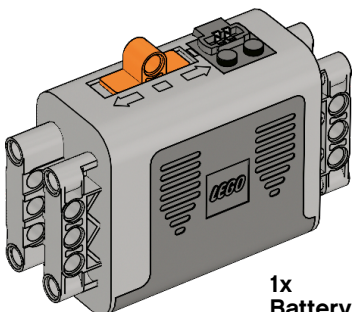

1x
Battery box, 9V, grey
4506078

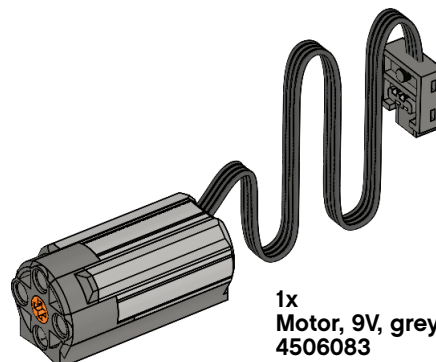

1x
Motor, 9V, grey
4506083