

1

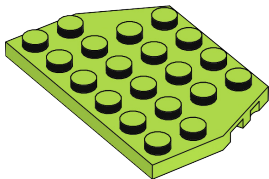

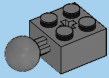

1x

2

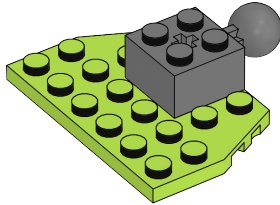



2x

3

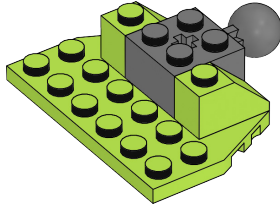



1x

4

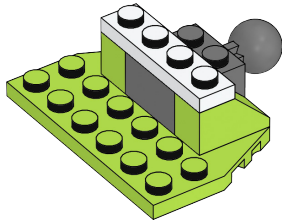

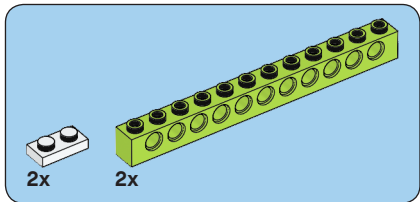

5

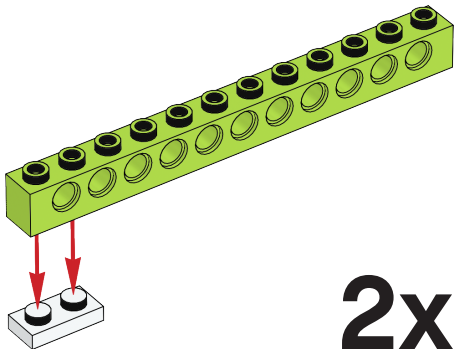

6

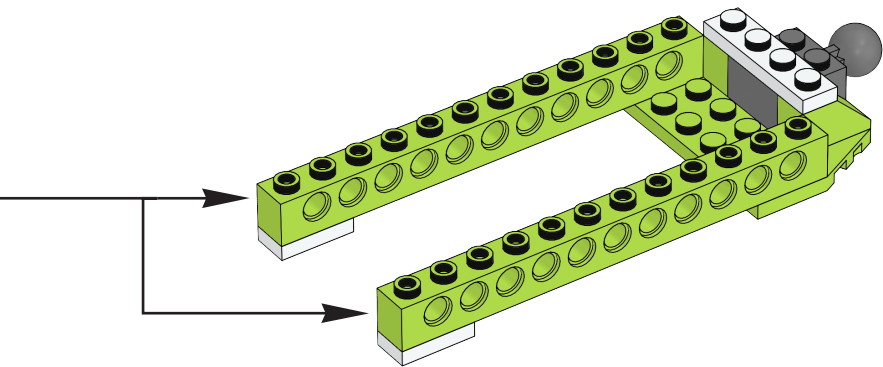

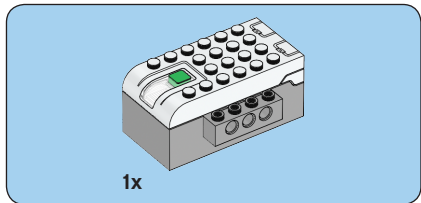

7

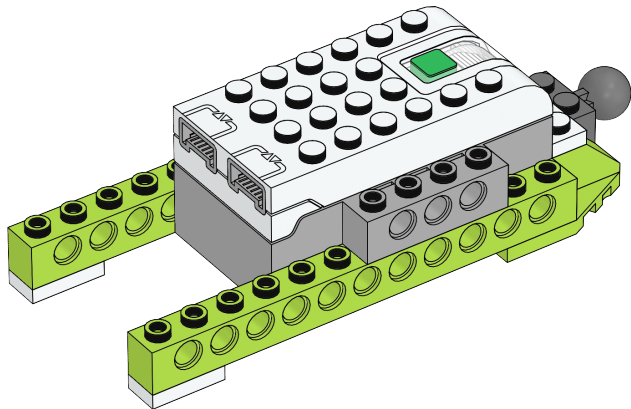



2x

8

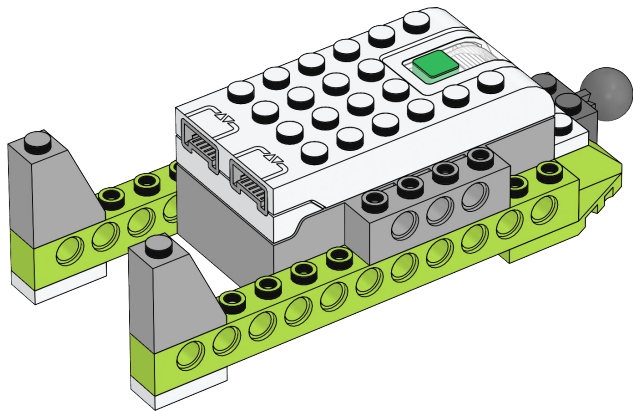

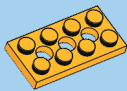

1x

9

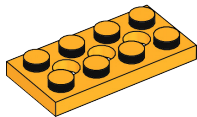

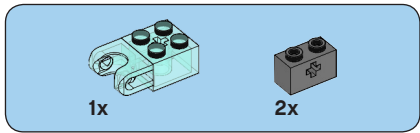

10

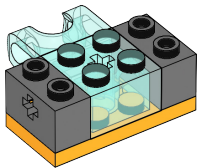

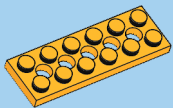

1x

11

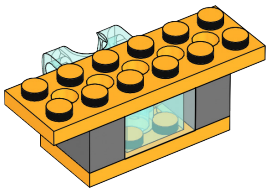



2x

12

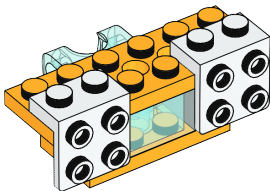



2x

13

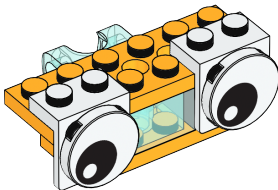

14

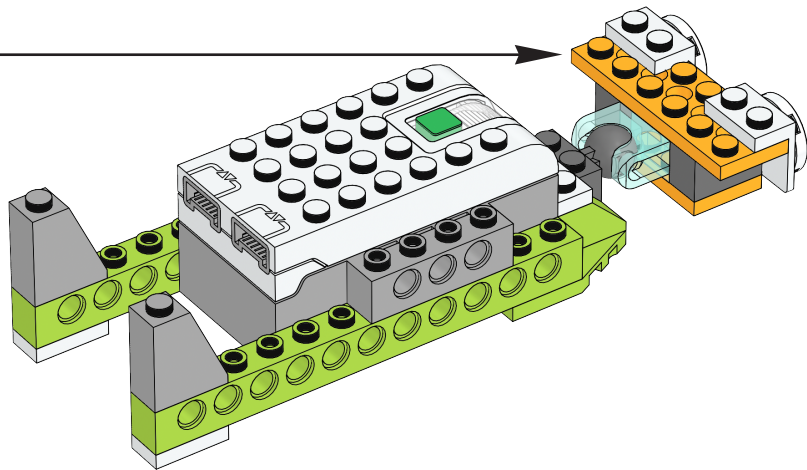

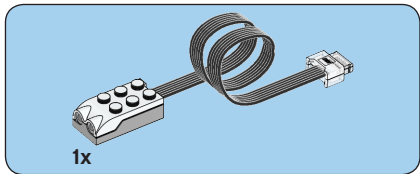

15

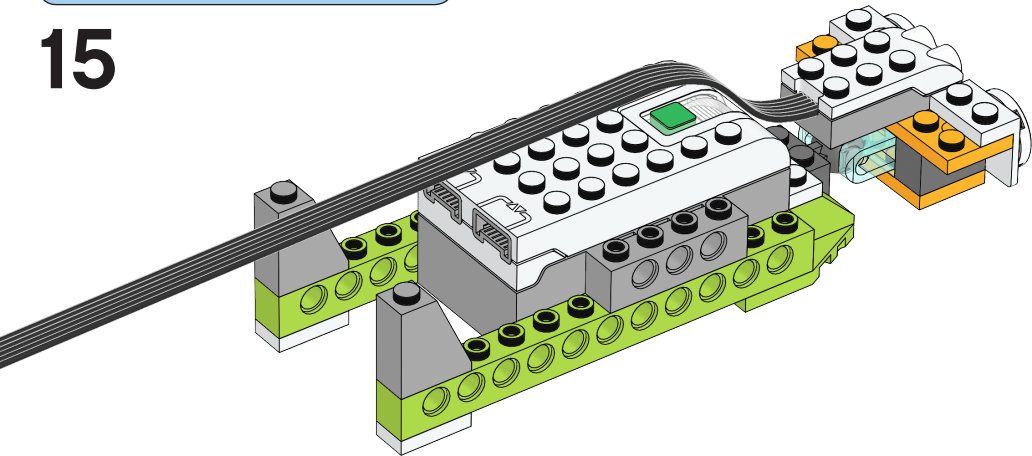

17

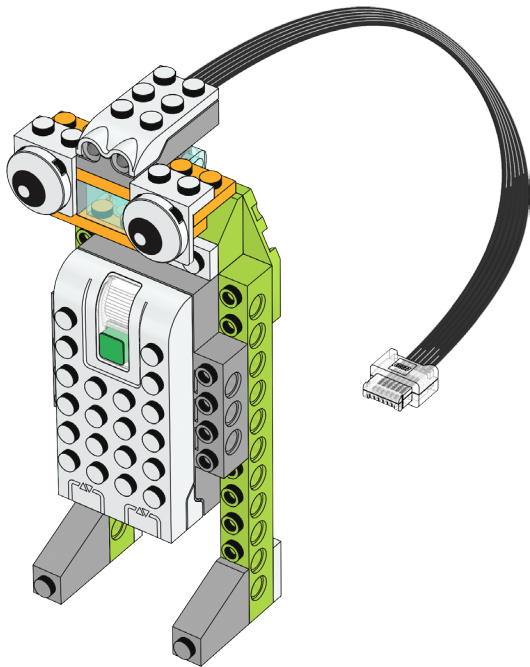

18

