

1

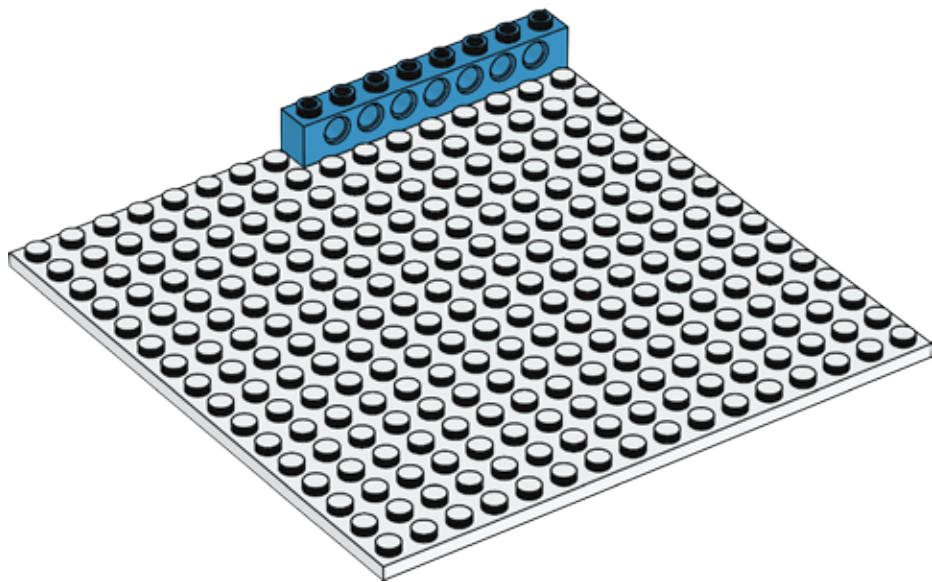

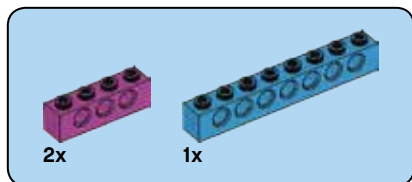

2

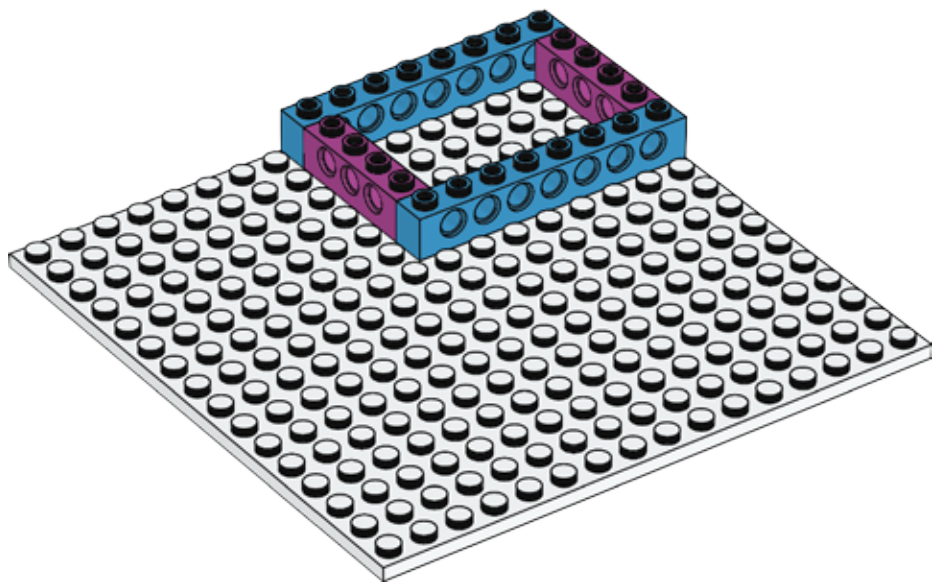

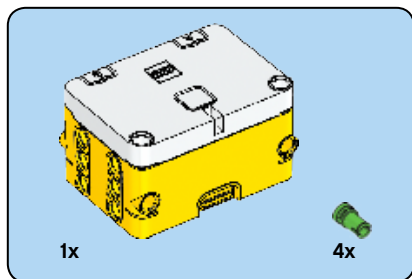

3

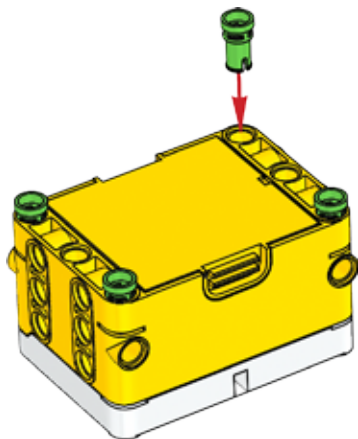

4

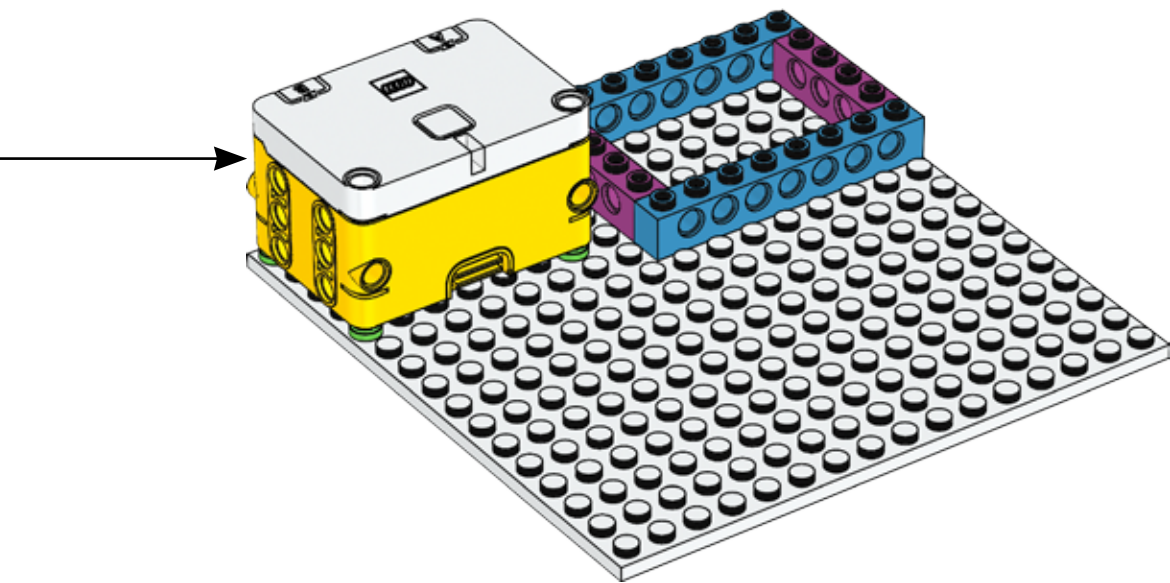

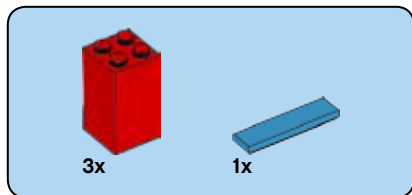

5

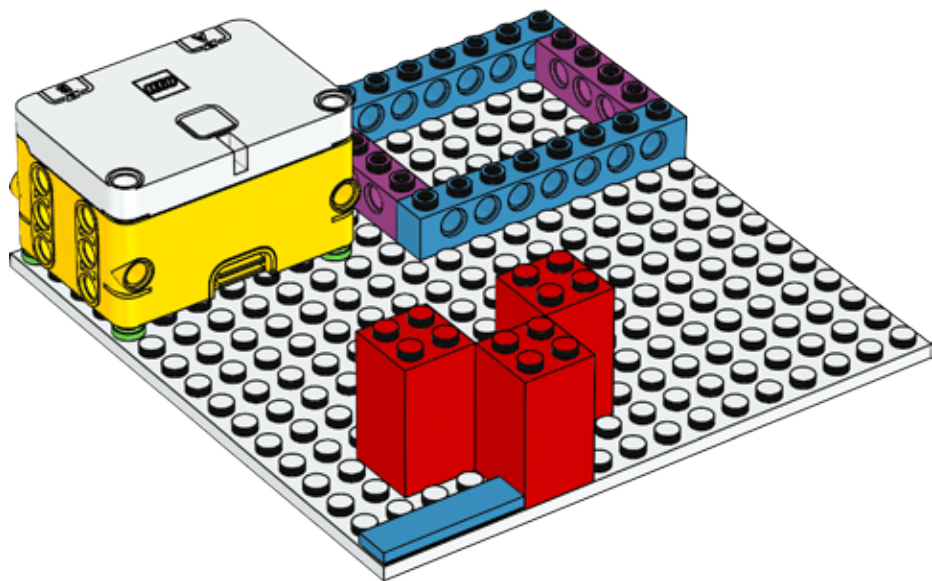

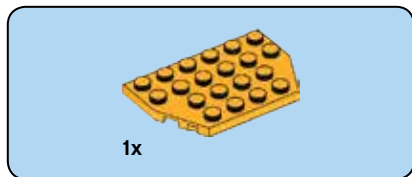

6

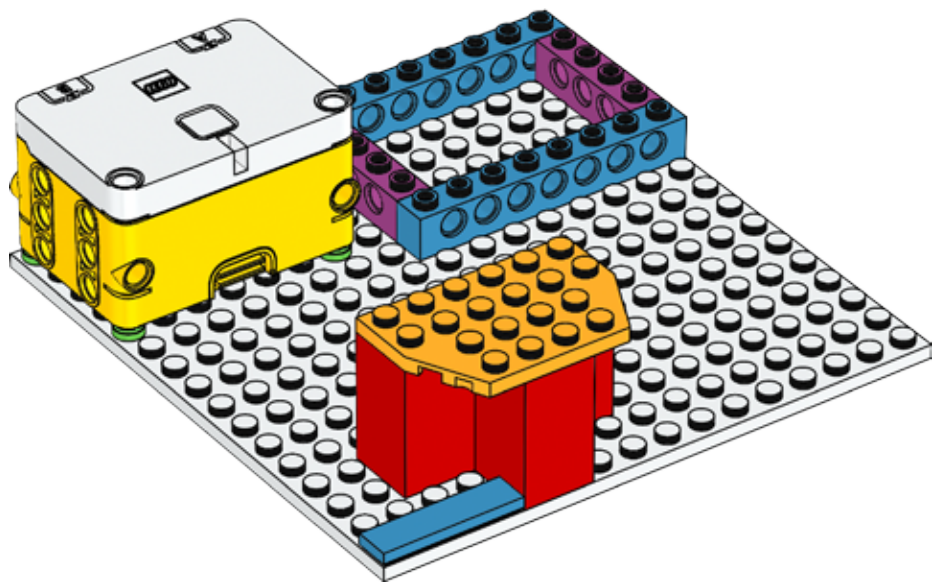



2x

7

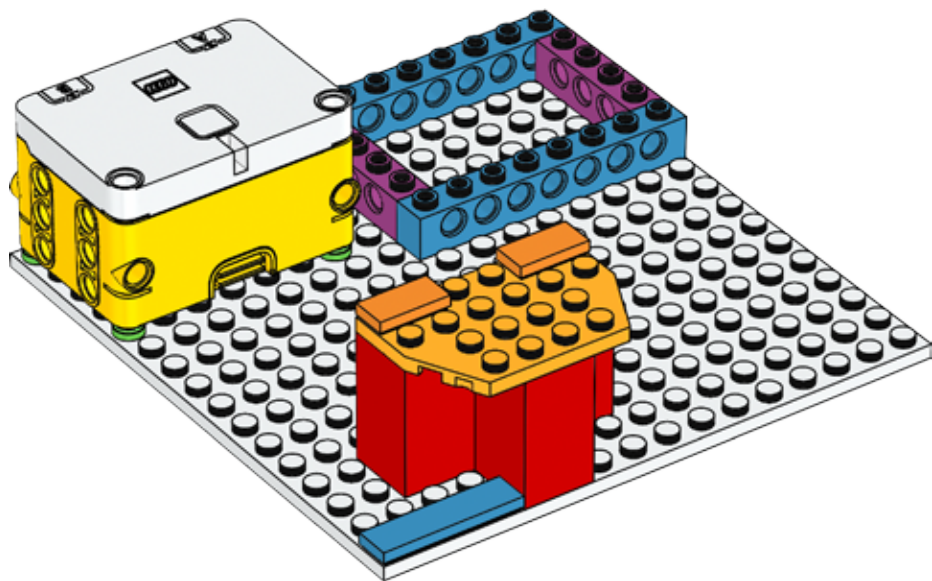

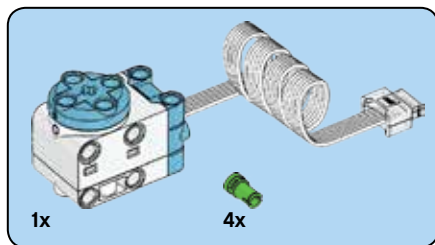

8

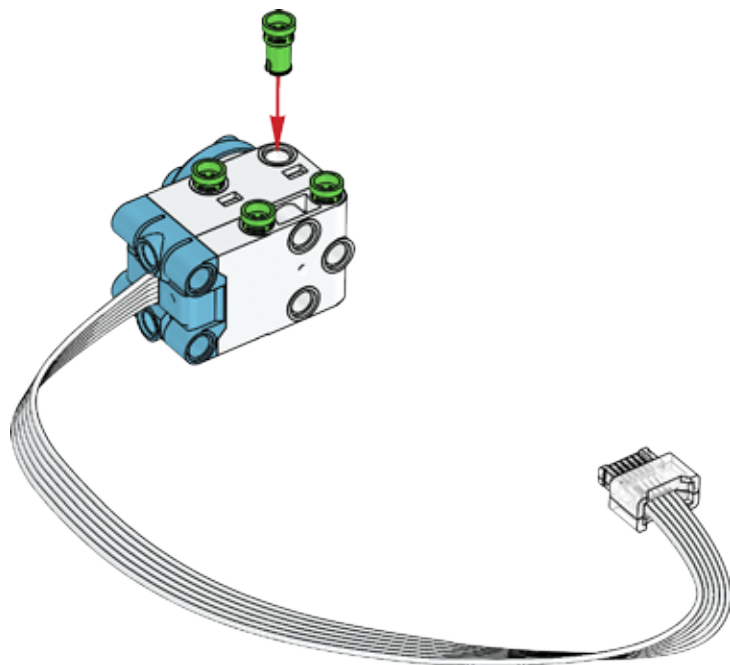

9

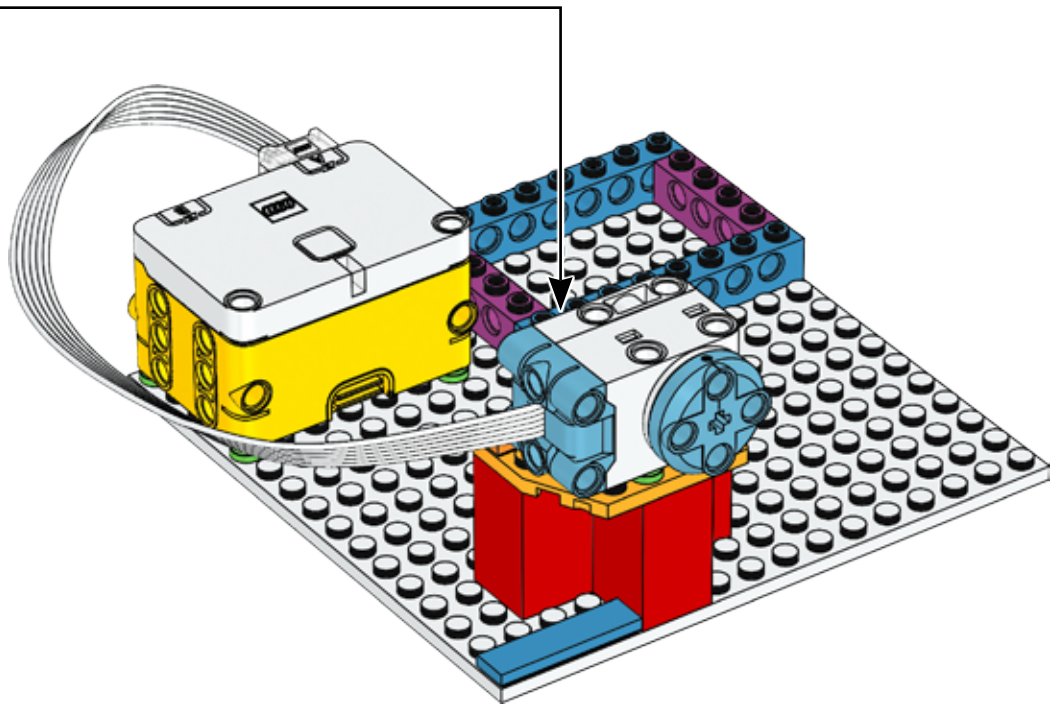



2x

10



2x

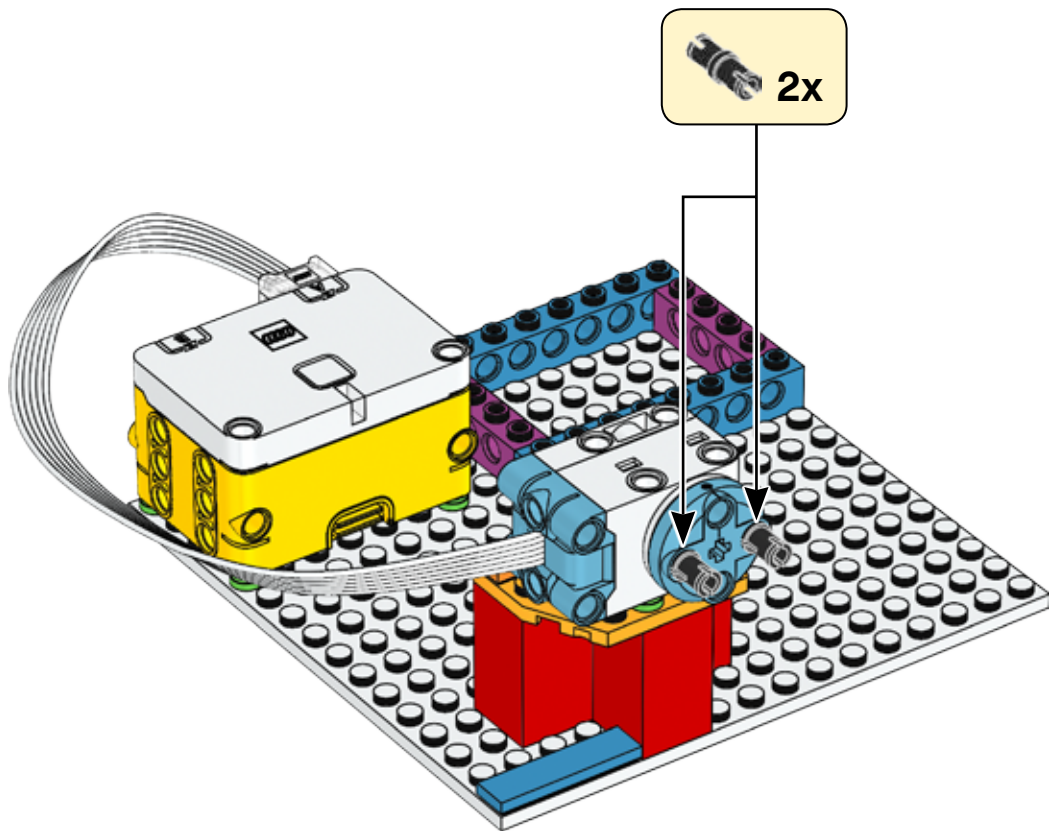

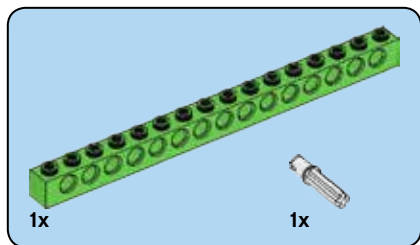

11

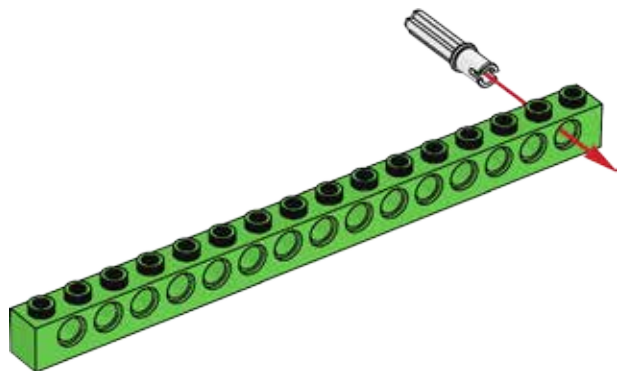

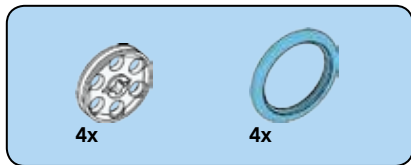

12

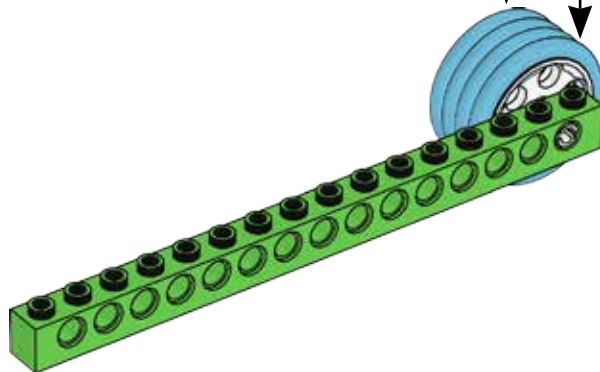
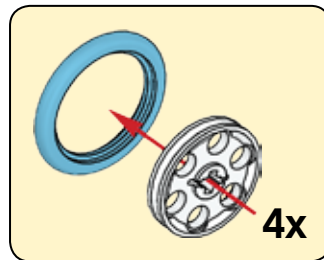

13

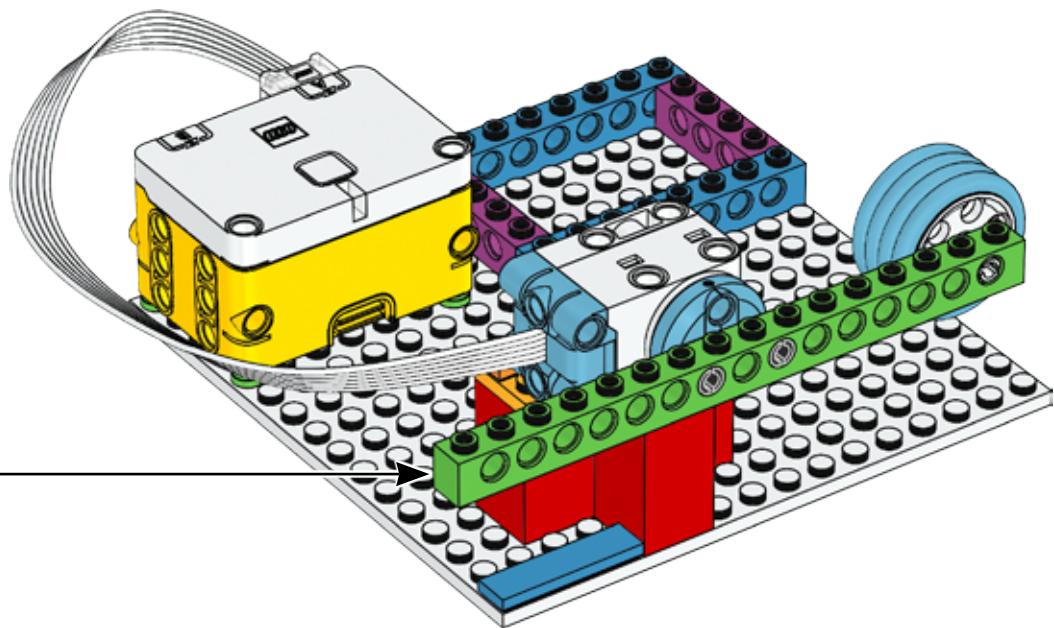

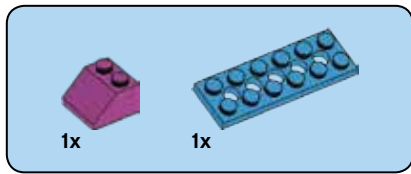

14

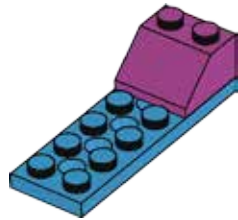



1x

15

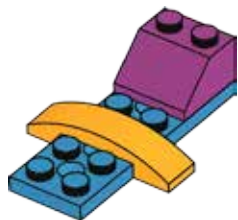

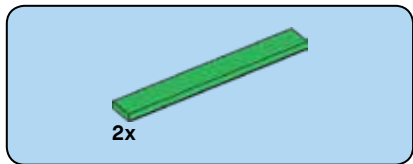

16

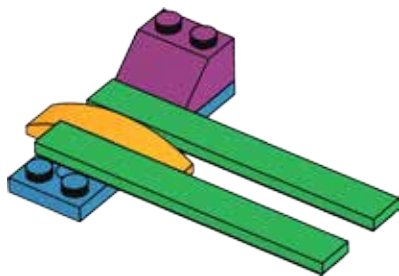



1x

17

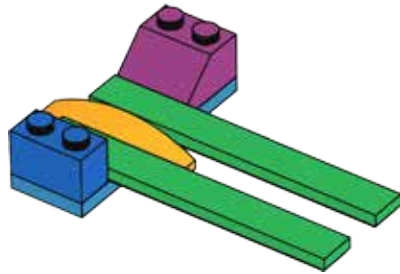

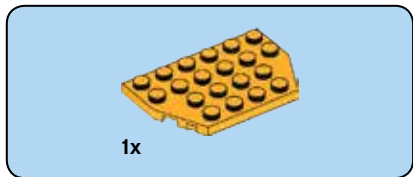

18

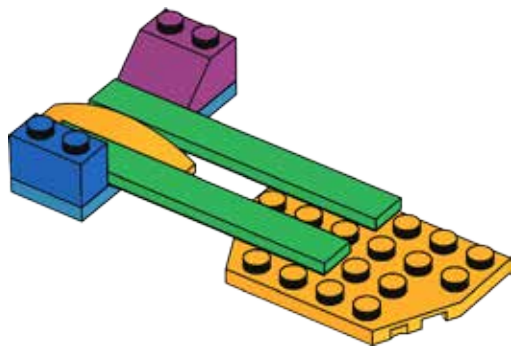

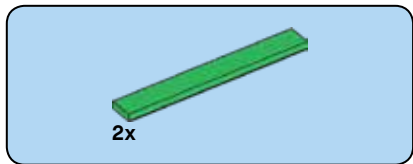

19

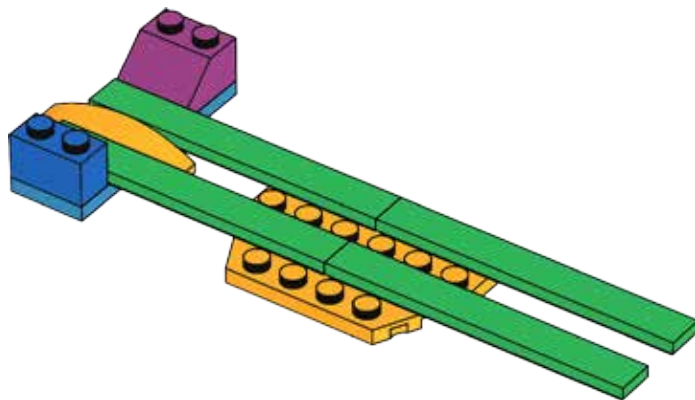



1x

20

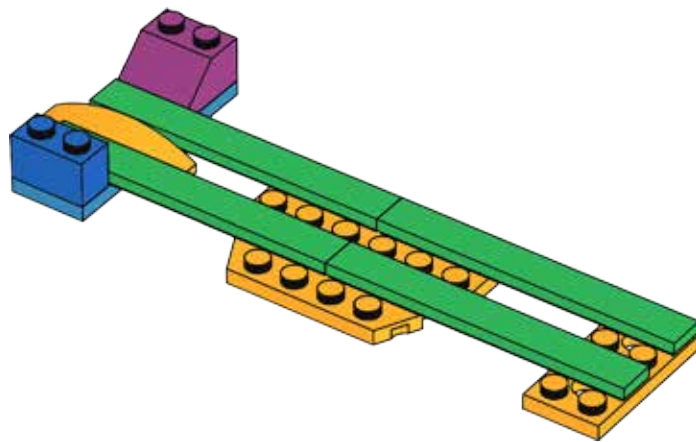



1x



1x

21

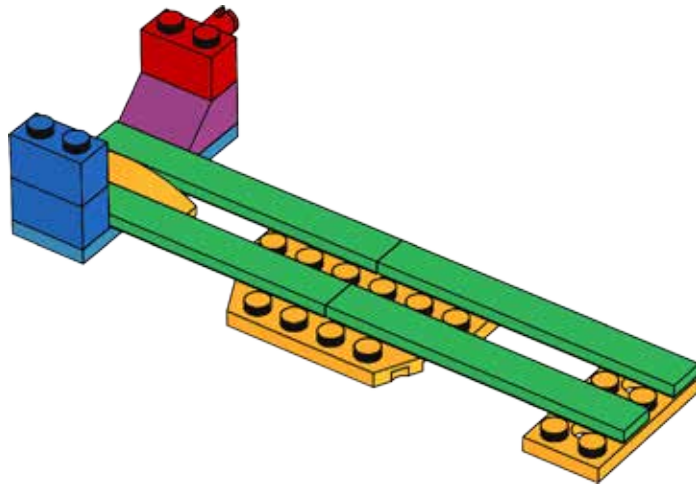

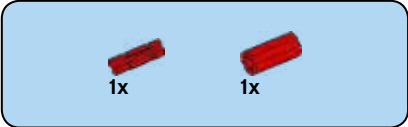

22

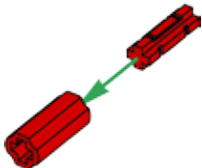

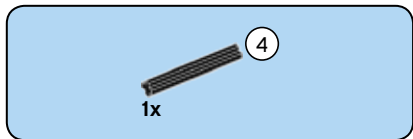

23

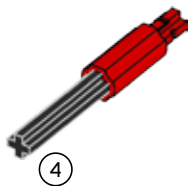

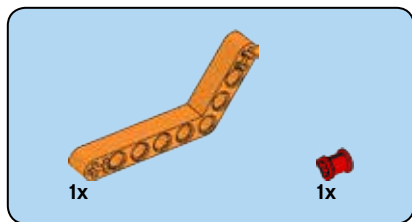

24

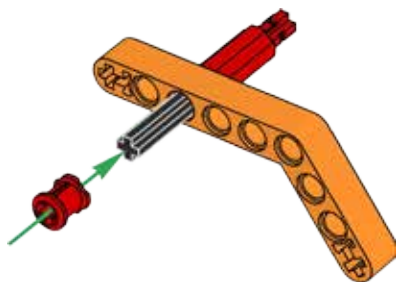



2x

25

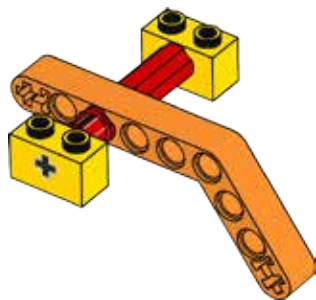

26

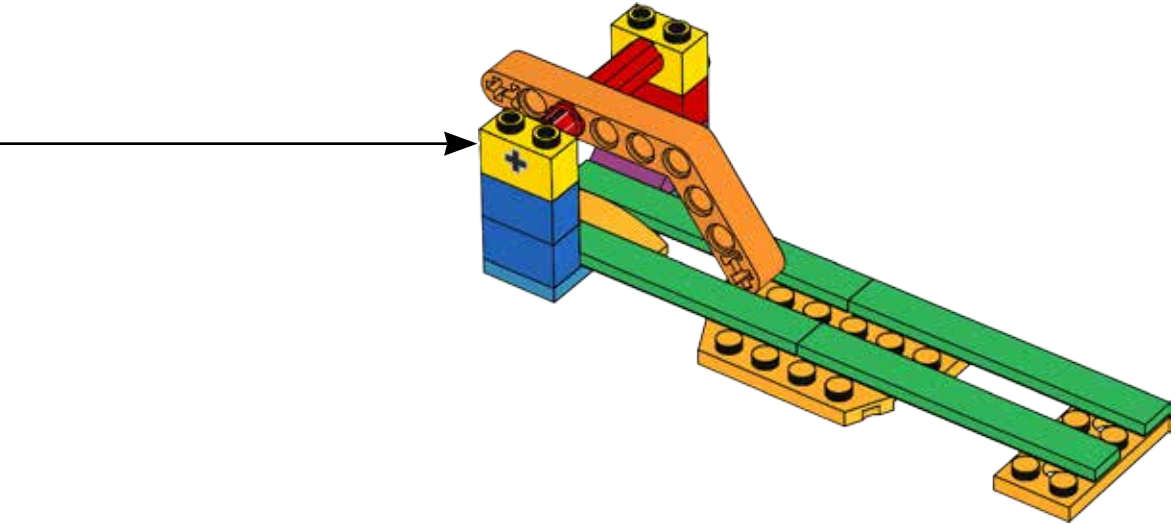

27

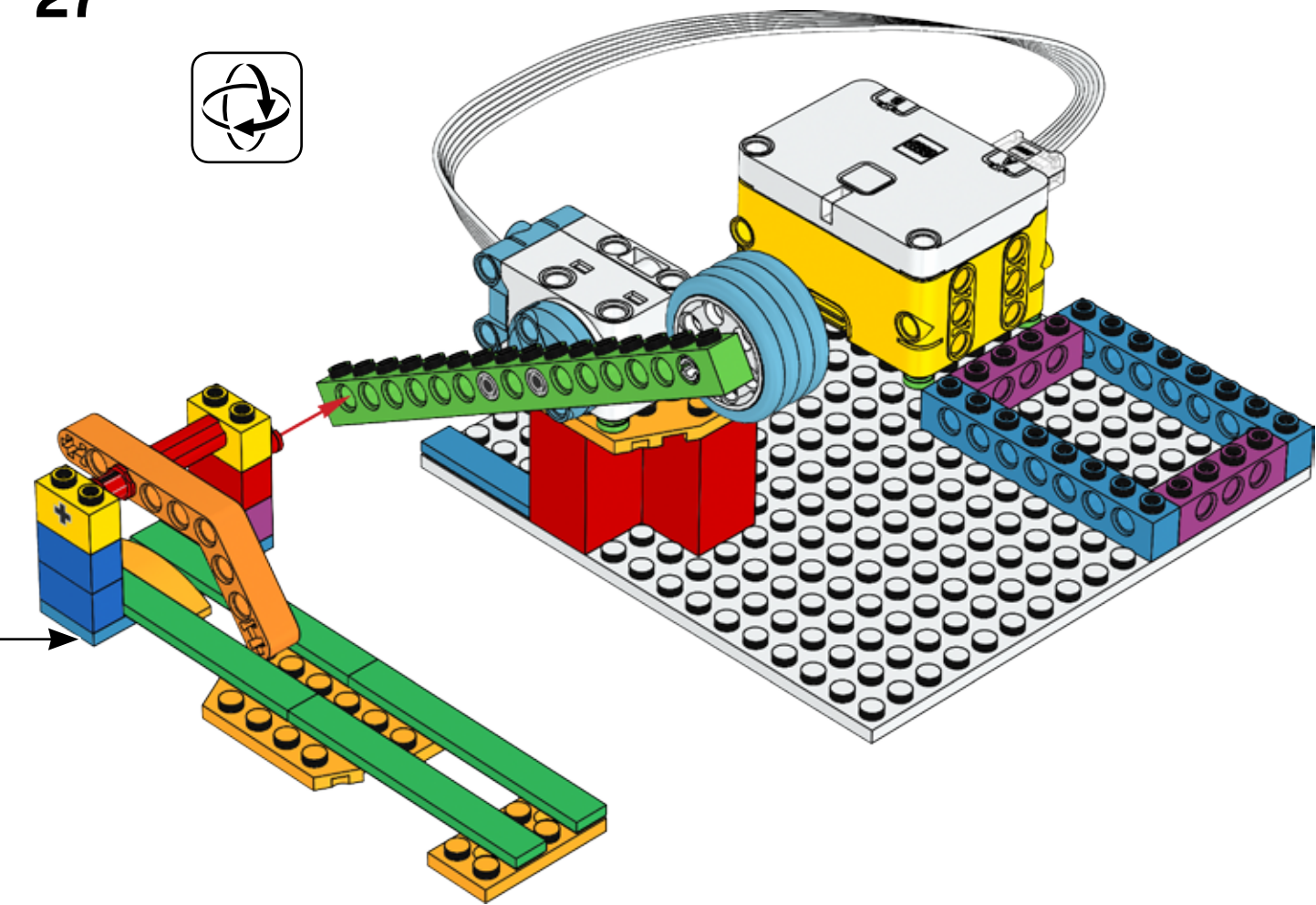



28

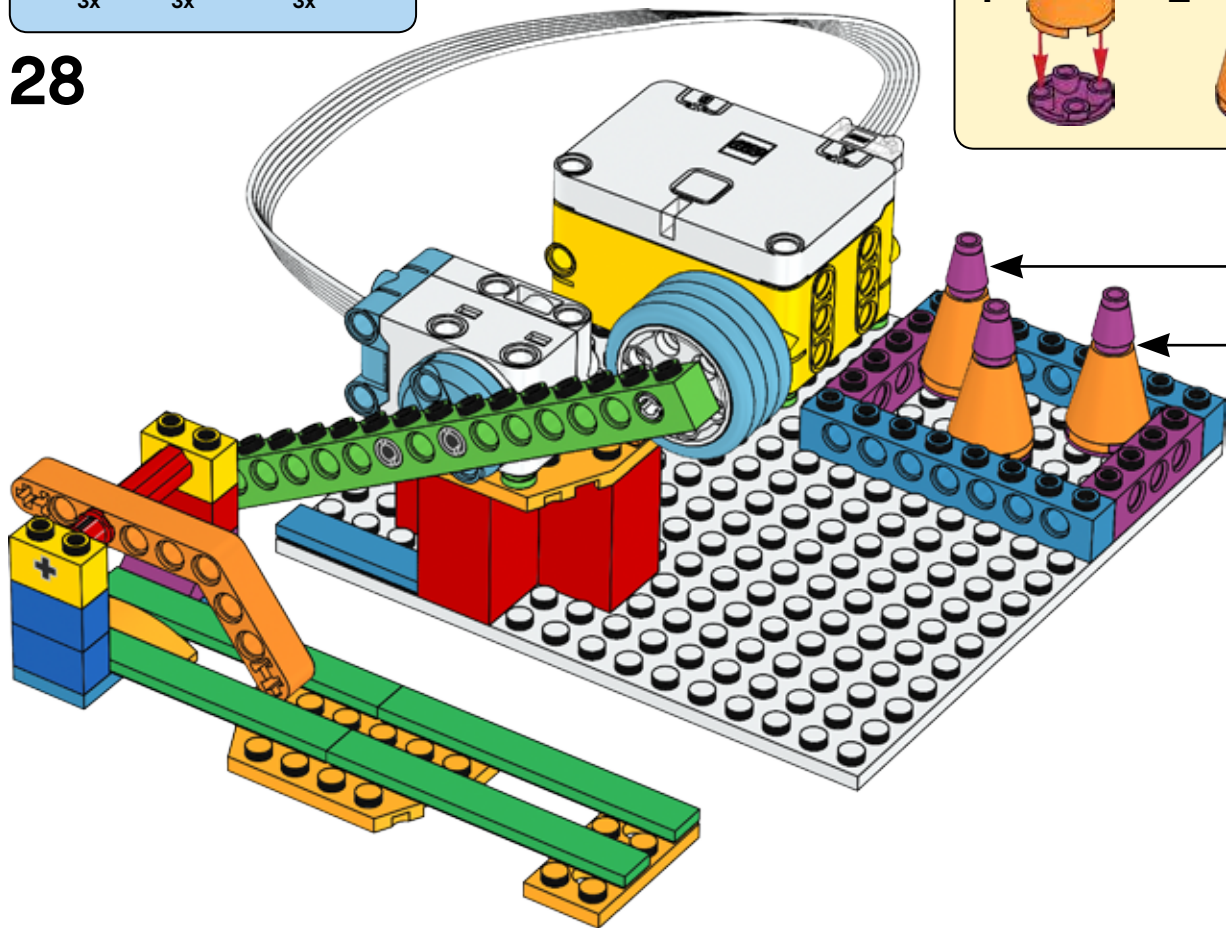
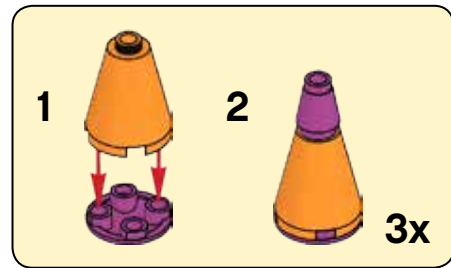



3x

29

